

50

# SHORT WAVE CRAFT

APRIL

★ Edited by  
HUGO GERNSBACK

1932

*Best Short Wave  
Station List  
of the World*

**When to hear  
the  
Foreign Stations**

**ALL IN THIS  
ISSUE**

*The  
Oscillo-dyne  
1 TUBE  
Wonder Set  
See Page 720*



**NOW  
25¢  
IN CENTS**

# ALL-WAVE RADIOS at NEW LOW PRICES

[ 15 to 560 Meters ]

Up goes the quality!  
Down goes the price!  
Midwest has scored another tremendous hit by bringing the ALL-WAVE radio within reach of every buyer. For only \$18.50, radio fans can buy this 8-tube LONG and SHORT wave super-heterodyne chassis, completely assembled with electrodynamic speaker. Never before such sensational value. Never before so much radio for so little money. Six months ago, such quality and such prices would have been impossible. Think of it! SUPER POWER, four distinct wave bands, 15 to 560 meter tuning range, coast-to-coast reception, police calls, foreign reception . . . all for as little as \$18.50. Only Midwest radio engineering skill backed by the engineering talent of R.C.A. and Am. T. & T. could produce such sensational radio value. Mail the coupon or write us a postal. You'll be amazed when you get full details.



**30  
DAYS  
FREE  
TRIAL**

**8-TUBE**  
Long and Short Wave  
**SUPER HETERODYNE**  
now only **\$18.50**  
COMPLETELY ASSEMBLED with LARGE SPEAKER

## What Midwest Owners Say

J. S. Kline, McGeehee, Ark.—“Listened to a set costing \$150.00 but would not swap my Midwest for the higher priced one.”

A. Edwards, 2125 North A St., Elwood, Ind.—“We wouldn't trade our Midwest for any of the numerous more costly sets.”

Emmet Berry, 222 29th St., Ashland, Ky.—“The Midwest cannot be beaten by any other radio that costs twice as much.”

Milton T. Lyman, 2525 Merwin St., Shreve-

port, La.—“Just as good as sets selling for double Midwest prices.”

Walter Fahrig, 1304 Highland Ave., Alton, Ill.—“Midwest is the best. Friends think I paid about \$300 for it.”

H. R. Peper, 436 Ferry St., New Haven, Conn.—“A neighbor of mine who recently purchased a \$200.00 radio went home very much dissatisfied after listening to our Midwest.”

only \$5.00 DOWN PUTS THIS RADIO IN YOUR HOME

**Deal Direct With Factory — Save UP TO 50%**

**MAIL THIS COUPON NOW!**

**Midwest Radio Corp.**  
Dept. 210  
Cincinnati, Ohio

Without obligation on my part send me your new 1933 catalog, complete details of your liberal 30-day free trial offer. This is NOT an order.

Name \_\_\_\_\_  
In \_\_\_\_\_  
Town \_\_\_\_\_ State \_\_\_\_\_

Midwest sweeps aside the costly old-fashioned way of selling through distributors and dealers. You buy direct from the Midwest factory. You save the middlemen's profits.

Investigate! Mail the coupon. Get the Midwest catalog. Learn the facts about the new Midwest 8-tube ALL-WAVE sets—also 6-tube sets, Battery sets and new Automatic Record Changing Radio-Phonograph at an extremely low price. Learn about our sensationally low factory prices, easy payment plan and positive guarantee of satisfaction or money back. Get a bigger, better, more powerful, better toned radio—at a positive saving of 30% to 50%!

**MIDWEST RADIO CORP.**

(Est. 1920)

Dept. 210 Cincinnati, Ohio

**NEW CONSOLE MODELS AS LOW AS \$21.95**

Also amazing new long wave console radio at a sensationally low price. Six new type tubes, dynamic speaker, automatic volume control and other new up-to-the-minute features found in sets selling for \$75.00 to \$100.00. Don't buy any radio until you get all the facts. Mail the coupon or write us a postal now.

COMPLETE WITH TUBES





J. E. Smith, President, National Radio Institute, the man who has directed the Home-Study training of more men for the Radio Industry than any other man in America.

# BE A RADIO EXPERT

Many Make **\$50 to \$100** a Week

I'll Train You at Home in Your Spare Time  
for **RADIO · TELEVISION · TALKING MOVIES**



### Set Servicing

Spare-time set servicing pays many N.R.I. men \$200 to \$1,000 a year. Full-time men make as much as \$65, \$75 and \$100 a week.



### Broadcasting Stations

Employ trained men continually for jobs paying up to \$5,000 a year.



### Ship Operating

Radio operators on ships see the world free and get good pay plus expenses. Here's one enjoying shore leave.

### Aircraft Radio

Radio is making flying safer. Radio operators employed through Civil Service Commission earn \$1,620 to \$2,800 a year.



### Talking Movies

An invention made possible by Radio. Employs many well trained Radio men for jobs paying \$75 to \$200 a week.



### Television

The coming field of many great opportunities is covered by my course.



If you are dissatisfied with your present job, if you are struggling along in a rut with little or no prospect of anything better than a skinny pay envelope—clip the coupon NOW. Get my big FREE book on the opportunities in Radio. Read how quickly you can learn at home in your spare time to be a Radio Expert—what good jobs my graduates have been getting—real jobs with real futures.

### Many Radio Experts Make \$50 to \$100 a Week

In about ten years the Radio Industry has grown from \$2,000,000 to hundreds of millions of dollars. Over 300,000 jobs have been created by this growth, and thousands more will be created by its continued development. Many men and young men with the right training—the kind of training I give you in the N.R.I. course—have stepped into Radio at two and three times their former salaries.

### Get Ready Now for Jobs Like These

Broadcasting stations use engineers, operators, station managers, and pay up to \$5,000 a year. Manufacturers continually employ testers, inspectors, foremen, engineers, service men, buyers, for jobs paying up to \$6,000 a year. Radio Operators on ships enjoy life, see the world, with board and lodging free, and get good pay besides. Dealers and jobbers employ service men, salesmen, buyers, managers, and pay up to \$100 a week. My book tells you about these and many other kinds of interesting Radio jobs.

### Many Make \$5, \$10, \$15 a Week Extra in Spare Time, Almost at Once

The day you enroll with me I send you instructions which you should master quickly for doing 28 jobs common in most every neighborhood, for spare-time money. Through-

out your course I send you information on servicing popular makes of sets! I give you the plans and ideas that have made \$200 to \$1,000 a year for N.R.I. men in their spare time. My course is famous as the course that pays for itself.

### Television, Short Wave, Talking Movies, Money-Back Agreement Included

Special training in Talking Movies, Television, and Home Television experiments, Short Wave Radio, Radio's use in Aviation, Servicing and Merchandising Sets, Broadcasting, Commercial and Ship Stations are included. I am so sure that N.R.I. can train you satisfactorily that I will agree in writing to refund every penny of your tuition if you are not satisfied with my Lesson and Instruction Service upon completion.

### 64-Page Book of Information FREE

Get your copy today. It's free to all residents of the United States and Canada over 15 years old. It tells you where Radio's good jobs are, what they pay, tells you about my course, what others who have taken it are doing and making. Find out what Radio offers you without the slightest obligation. Mail coupon in envelope or paste on postcard. ACT NOW!

J. E. SMITH, President  
National Radio Institute  
Dept. 3DB3  
Washington, D. C.



## SPECIAL FREE OFFER

Act now and receive in addition to my big free book, "Rich Rewards in Radio," this Service Manual on D.C., A.C., and Battery operated sets.



Only my students could have this book in the past. Now readers of this magazine who mail the coupon will receive it free. Overcoming hum, noises of all kinds, fading signals, broad tuning, howls and oscillations, poor distance reception, distorted or muffled signals, poor Audio and Radio Frequency amplification and other vital information is contained in it. Get a free copy by mailing the coupon below.

THIS COUPON IS GOOD for  
**One FREE COPY OF MY BOOK** *mail it now*

J. E. SMITH, President  
National Radio Institute, Dept. 3DB3  
Washington, N. C.

Dear Mr. Smith: I want to take advantage of your Special Offer. Send me your two books, "Trouble Shooting in D.C., A.C., and Battery Sets" and "Rich Rewards in Radio." I understand this does not obligate me.

Name ..... Age.....  
Address .....  
City ..... Sta. "M"

**IN THIS ISSUE: PROMINENT SHORT-WAVE AUTHORS**

**Marconi • Wallace • Palmer • Hooton • Millen • Brown • Tanner**



**HUGO GERNSBACK**  
Editor

**H. WINFIELD SECOR**  
Managing Editor

**CONTENTS FOR APRIL, 1933**

**FEATURES:**

Editorial—Make Money With Short-Wave Sets, by Hugo Gernsback ..... 709

Radio On The Ultra Short Waves, by Marchese Guglielmo Marconi ..... 710

Ham's Life Saved by 20,000 Mile Code Flash..... 713

The New Daventry Station..... 714

Some Things You Don't Know About S-W Aerials, by Don C. Wallace..... 715

The Cigar-Box 1-Tube "Catch-All", by F. L. Battles ..... 716

Mr. Myers Modernizes His 3-Tube S-W Receiver.... 717

How I Learned To Handle CODE With Speed and Accuracy, by Theodore R. McElroy..... 719

The Oscillodyne 1-Tube Wonder Set, by J. A. Worcester ..... 720

A South American 7-Tube All Wave Superhet, by P. P. Baldwin and C. W. Palmer..... 722

A New National S-W Superhet—The FB 7, by James Millen, General Manager, The National Company ..... 726

The Lincoln R 9—A New 9 to 200 Meter S-W Superhet—Uses 11 Tubes..... 729

The Short-Wave Beginner—Radio Symbols and How to Read Them on Diagrams, by C. W. Palmer ..... 730

Newest BOSCH 10-Tube Multi-Wave Superheterodyne ..... 733

A New Form of Tuning Inductance, by Rinaldo de Cola ..... 734

Short-Wave Stations of the World—A New REVISED LIST ..... 738

**SHORT-WAVE RECEIVERS:**

1-Tube "Catch All" Built in a Cigar Box..... 716

A "Snappy" 3-Tube S-W Receiver, by I. O. Myers.. 717

An All-Purpose Receiver Which Also Serves as Test Oscillator, Wavemeter or Monitor, by J. W. Cullen, W9CIN ..... 718

The Oscillodyne 1-Tube Wonder Set—"Cover Feature" ..... 720

7-Tube Short and Broadcast Wave Superhet..... 722

A 3-Tube Receiver—Improved "Go-Getter," by H. D. Hooton ..... 725

The New National Superhet—The FB 7 ..... 726

The New Lincoln R-9 Short-Wave Receiver..... 729

A High-Gain 2-Tube S-W Receiver, by H. V. Mac-Millan ..... 732

The Bosch 10-Tube Multi-Wave Superhet Receiver—Receives "Short" and "Broadcast" Waves..... 733

**SHORT-WAVE TRANSMITTERS:**

Ultra Short-Wave Transmitters, by Guglielmo Marconi ..... 710

The New "Beam" Transmitting Station at Daventry (England) ..... 714

How I Learned to Handle Code With Speed and Accuracy, by Theodore R. McElroy ..... 717

An All Purpose Receiver Which Can Be Used As a Transmitter ..... 718

A Crystal Detector Wavemeter for Ultra Short Waves and How to Calibrate It ..... 735

**FOR THE BROADCAST LISTENER:**

A 7-Tube "All-Wave" Superhet—How To Build It ..... 722

The New National Short-Wave Superhet, FB 7—Broadcast Coils Available ..... 726

**FEATURES IN NEXT ISSUE**

- A new super-regenerative SW receiver, by Clifford E. Denton. The SWC reader's ideal "composite" receiver.
- A new powerful 3-tube band spread receiver—brings in foreign stations on a loud speaker, by George Shuart.
- Building a "Depression" transmitter, by John T. Frye.
- An Improved Super-Regenerator, by J. A. Grater.
- Another Short-Wave "Fiction" Story, by A. D. Middleton.
- A 3-Tube "Stand-By" from a Radiola V, by A. R. Appelman.
- A "TNT" Transmitter for 160 Meters, by Hal Sullivan, WIAAD.
- A 2-Volt 3-Tube Ham Receiver, by Lewis M. Ewing.

*Contents for APRIL—Continued*

The New Bosch 10-Tube Multi-Wave Superheterodyne ..... 733

Short Wave Stations of the World—New REVISED LIST ..... 738

**MISCELLANEOUS:**

Some Things You Don't Know About S-W Aerials.... 715

Tips On How To Send and Receive Code Accurately ..... 719

A Good 250 Volt Power Supply for Less Than \$5.00, by Albert W. Friend, B.S., E.E., W8DSJ.. 728

The Short-Wave Beginner—with Symbol Chart..... 730

\$20.00 Prize Monthly for Best Set—Rules and Conditions ..... 732

A New Form of Tuning Inductance ..... 734

A Crystal Detector Wavemeter ..... 735

\$5.00 For Best Short-Wave "KINK" ..... 736

**SHORT WAVE LEAGUE** ..... 737

Short Wave Stations of the World—new REVISED LIST ..... 738

What Our Readers Think ..... 742

Short Wave QUESTION BOX, edited by R. William Tanner ..... 743

When To Listen In, by Bob Hertzberg ..... 744

**OUR COVER**

The Oscillodyne 1-Tube Wonder Set—a 1-Tube Receiver which has picked up "DX" stations without aerial or ground and which operates on a brand new principle. Described by its inventor, J. A. Worcester, on page... 720

**SHORT-WAVE CRAFT**—Monthly. Entered as second class matter May 7, 1930, at the post office at Mount Morris, Illinois, under the act of March 3, 1879. Trademarks and copyrights by permission of H. Gernsback, 98 Park Place, N. Y. C. Text and illustrations of this magazine are copyrighted and must not be reproduced without permission. **SHORT WAVE CRAFT** is published on the 15th of every month. Twelve numbers per year. Subscription price is \$2.50 a year in the United States and possessions. Canada and foreign countries, \$3.00 a year. Single copies 25c. Address all contributions for publication to Editor, **SHORT WAVE CRAFT**, 96-98 Park Place, New York, N. Y. Publishers are not responsible for lost manuscripts. Contributions cannot be returned unless authors remit full postage. **SHORT WAVE CRAFT** is for sale at all principal newsstands in the United States and Canada. European agents: Brentano's, London and Paris. Printed in U. S. A. Make all subscription checks payable to Popular Book Corporation.

COPYRIGHT, 1933, BY H. GERNSBACK

Published by **POPULAR BOOK CORPORATION**

**HUGO GERNSBACK**, President - - **H. W. SECOR**, Vice-President  
**EMIL GROSSMAN** - - - - - Director of Advertising  
 Chicago Adv. Office - - - **L. F. McCLURE**, 737 No. Michigan Blvd.  
 Publication Office - - - 404 N. Wesley Avenue, Mount Morris, Ill.  
 Editorial and General Offices - - 96-98 Park Place, New York, N. Y.  
 London Agent: **HACHETTE & CIE.**, 16-17 King William St., Charing Cross, W.C.2

Paris Agent: **HACHETTE & CIE.**, 111 Rue Reaumur  
 Australian Agents: **McGILL'S AGENCY**, 179 Elizabeth St., Melbourne

I alone  Guarantee  
 Consistent ~ day in and day out  
**WORLD-WIDE RECEPTION**

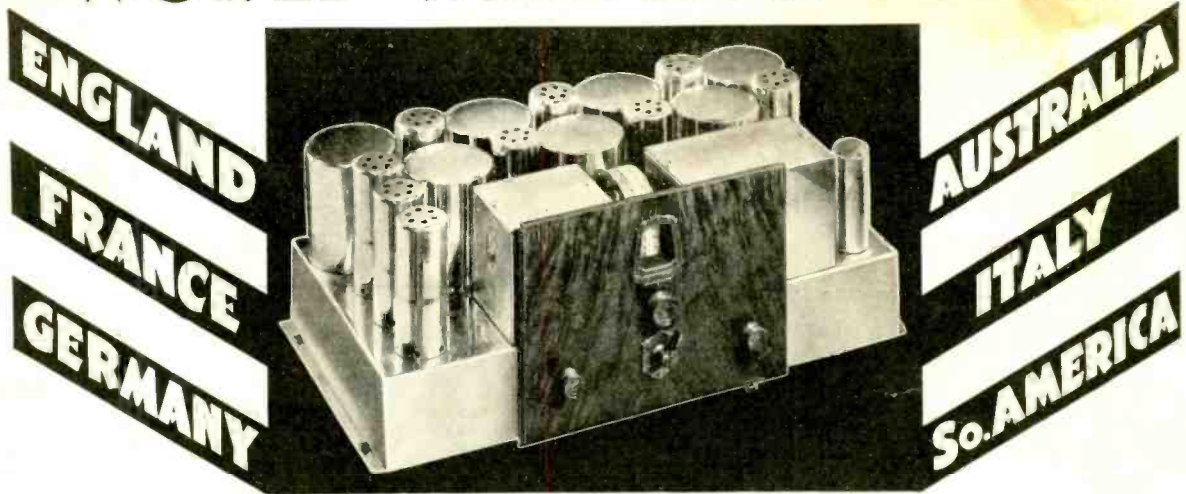

The **SCOTT** 15-550 METER ALL-WAVE *Deluxe* **RADIO**

There are no "ifs" "buts" "under favorable conditions" or other equivocations in the SCOTT guarantee. It says, simply and clearly, that the set I build for you will receive foreign broadcasts from stations as far as 10,000 miles away, with loud-speaker volume, consistently, at all seasons of the year.

In addition, every part of the set (except tubes) is guaranteed against breakdown or service failure for a five-year period instead of the ordinary 90-day term.

Beside bringing you dependable direct short wave reception of advertising-free foreign programs, this remarkable radio will receive literally everything upon the North American continent on the regular broadcast band. Its rich, natural tone is a revelation—giving you reproduction of voice and music so exact that variation from actuality can be measured only with super-delicate instruments, being undetectable by the human ear.

Such performance comes only from exacting laboratory construction, constantly checked and tested by extensive scientific equipment. Backing it is the SCOTT experience of more than eight years in building world's-record-breaking radio receivers.

Claims are easily made—a *Guarantee* is something different! Which do you want—the *hope* that your receiver can deliver performance, or *positive assurance* that it will?

Then send at once for all particulars about the radio known as "The World's Finest Receiver."

**E. H. SCOTT RADIO LABORATORIES, INC.**  
 4450 Ravenswood Ave., Dept. SWC-43, Chicago, Ill.

**Winning Praise Galore • Vindicating All Claims**

Here are just a few extracts from hundreds of letters of praise on file in my laboratories, which may be inspected by anyone. "Your claims of 10 kilocycle selectivity 100% correct," SGP, Ala. . . "Regarding tone, nothing could be finer," FW, Calif. . . "Stations all the way from Berlin to Tokio and Australia," JBT, Conn. . . "VK3ME, Melbourne, 10,500 miles from here, received each time on the air," CGB, Conn. . . "European stations as much 'at my finger tips' as ordinary locals," TPB, D. C. . . "Listen to Madrid every night while eating dinner," WHB, Ind. . . "Seven year old son regularly receiving RW59—VK2ME—VK3ME—EAQ—DJA—2RO—G5SW—Pon-toise and many more," CK, Maine. . . "Madrid on short waves (direct) just as good as WAAB rebroadcasts it," JJO'C, Mass. . . "After so much untruthful advertising it is very gratifying to get a radio set that really does what is claimed for it," CEMcK, Mo. . . "First station tuned in was VK2ME Australia. Boy, what a set!" LGD, N. J. . . "Triumphant vindication of all claims you make for it; performance convinces me you have been extremely conservative in outlining its potentialities," RD, N. Y. . . "Simply too wonderful for words," HCVS, So Africa. . . "Performance really wonderful," MC, Paris, France.

*These New Brochures Tell the*  
**"SCOTT SECRET"**

**MAIL THIS COUPON NOW**

E. H. SCOTT RADIO LABORATORIES, INC.  
 4450 Ravenswood Ave., Dept. SWC-43, Chicago, Ill.  
 Send me complete details about the SCOTT ALL-WAVE  
 DELUXE RADIO, explaining why this set *Guarantees* the  
 performance that others only claim.

Name .....

Address .....

Town ..... State .....

# ... SHORT WAVE ESSENTIALS FOR MEMBERS OF THE SHORT WAVE LEAGUE ...

**T**HE following list of short wave essentials has been prepared from the suggestions to the LEAGUE by its members. A number of months were consumed in creating these short wave essentials for members of the SHORT WAVE LEAGUE. All essentials listed are approved by headquarters of the LEAGUE.

### A FEW WORDS AS TO THE PURPOSE OF THE LEAGUE

The SHORT WAVE LEAGUE was founded in 1930. Honorary Directors are as follows:

Dr. Lee de Forest. John L. Reinartz, D. E. Replogle, Hollis Baird, E. T. Somerset, Baron Manfred von Ardenne, Hugo Gernsback, Executive Secretary.

The SHORT WAVE LEAGUE is a scientific membership organization for the promotion of the short wave art. There are no dues, no fees, no initiations, in connection with the LEAGUE. No one makes any money from it; no one derives any salary. The only income which the LEAGUE has is from its short wave essentials. A pamphlet setting forth the LEAGUE'S numerous aspirations and purposes will be sent to anyone on receipt of a 3c stamp to cover postage.

One of the aspirations of the SHORT WAVE LEAGUE is to enhance the standing of those engaged in short waves. To this end, the SHORT WAVE LEAGUE supplies members with membership letterheads and other essentials. As soon as you are enrolled as a member, a beautiful certificate with the LEAGUE'S seal will be sent to you, providing 10c in stamps or coin is sent for mailing and handling charges.

Another consideration which greatly benefits members is that they are entitled to preferential discounts when buying radio merchandise from numerous firms who have agreed to allow lower prices to all SHORT WAVE LEAGUE members. The radio industry realizes that, the more earnest workers there are who boost short waves, the more radio business will result therefrom; and a goodly portion of the radio industry is willing, for this reason, to assist SHORT WAVE LEAGUE members by placing them on a professional basis.

### SHORT WAVE ESSENTIALS LISTED HERE SOLD ONLY TO SHORT WAVE LEAGUE MEMBERS

All the essentials listed on this page are never sold to outsiders. They cannot be bought by anyone unless he has already enrolled as one of the members of the SHORT WAVE LEAGUE or signs the blank on this page (which automatically enrolls him as a member, always provided that he is a short wave experimenter, a short wave fan, radio engineer, radio student, etc.).

If, therefore, you order any of the short wave essentials without filling out the blank (unless you already enrolled as a LEAGUE member), your money will be returned to you.

Inasmuch as the LEAGUE is international, it makes no difference whether you are a citizen of the United States or any other country. The LEAGUE is open to all.

### Application for Membership SHORT WAVE LEAGUE

SHORT WAVE LEAGUE (4-33)  
98 Park Place, New York, N. Y.

I, the undersigned, herewith desire to apply for membership in the SHORT WAVE LEAGUE. In joining the LEAGUE I understand that I am not assessed for membership and that there are no dues and no fees of any kind. I pledge myself to abide by all the rules and regulations of the SHORT WAVE LEAGUE, which rules you are to send to me on receipt of this application.

I consider myself belonging to the following class (put an X in correct space): Short Wave Experimenter  Short Wave Fan  Radio Engineer  Student

I own the following radio equipment:

Transmitting.....

Call Letters.....

Receiving.....

Name.....

Address.....

City and State.....

Country.....

I enclose 10c for postage and handling for my Membership Certificate.

### SHORT WAVE LEAGUE LETTERHEADS

A beautiful letterhead has been designed for members' correspondence. It is the official letterhead for all members. The letterhead is invaluable when it becomes necessary to deal with the radio industry, mail order houses, radio manufacturers, and the like; as many houses have offered to give members who write on the LEAGUE'S letterhead a preferential discount. The letterhead is also absolutely essential when writing for verification to radio stations either here or abroad. It automatically gives you a professional standing.

A—SHORT WAVE LEAGUE letterheads, per 100..... 50c

### OFFICIAL SHORT WAVE LEAGUE LOG AND CALL BOOK

Here is the finest book of its kind ever published. It contains the largest listing of short wave stations in the world, much larger in fact than the list published in SHORT WAVE CRAFT and other magazines. All experimental stations, no matter where located, are listed. A large section is provided where calls can be listed in a proper manner. This log section gives dial settings, time, date, call letters, location, and other information. Another section has squared-paper pages on which you can fill in your own frequency curve for your particular receiver. It helps you to find stations which otherwise you could never log. It is the only book of its kind published.

B—Official Log and Call Book..... Prepaid 25c

### RADIO MAP OF THE WORLD AND STATION FINDER

The finest device of its kind published. The world's map on heavy board is divided into 23 sections, while the rotary disc shows you immediately the exact time in any foreign country. Invaluable in logging foreign stations. Also gives call letters assigned to all nations. Size 11"x22".

C—Radio Map of the World and Station Finder..... Prepaid 25c

### GLOBE OF THE WORLD AND MAGNETIC COMPASS

This highly important essential is an ornament for every den or study. It is a globe, 6 in. in diameter, printed in fifteen colors, glazed in such a way that it can be washed. This globe helps you to intelligently log your foreign stations. Frame is of metal. Entire device substantially made, and will give an attractive appearance to every station, emphasizing the long-distance work of the operator.

D—Globe of the World..... Prepaid \$1.25

### SHORT WAVE LEAGUE LAPEL BUTTON

This beautiful button is made in hard enamel in four colors, red, white, blue and gold. It measures three quarters of an inch in diameter. By wearing this button, other members will recognize you and it will give you a professional air. Made in bronze, gold filled, *not plated*. Must be seen to be appreciated.

E—SHORT WAVE LEAGUE lapel button..... Prepaid 35c

F—SHORT WAVE LEAGUE lapel button, like the one described above but in solid gold..... Prepaid \$2.00

### SHORT WAVE LEAGUE SEALS

These seals or stickers are executed in three colors and measure 1 1/4 in. in diameter, and are gummed on one side. They are used by members to affix to stationery, letterheads, envelopes, postal cards and the like. The seal signifies that you are a member of the SHORT WAVE LEAGUE. Sold in 25 lots or multiples only.

G—SHORT WAVE LEAGUE seals..... per 25, Prepaid 15c

### SHORT WAVE MAP OF THE WORLD

This beautiful map, measuring 18x26 in. and printed in 18 colors is indispensable when hung in sight or placed "under the glass" on the table or wall of the short wave enthusiast. It contains a wealth of information such as distances to all parts of the world, political nature of the country in which a broadcast station is located, etc., and from the manner in which the map is blocked off gives the time in different parts of the world at a glance.

F—SHORT WAVE Map of the World..... Prepaid 25c

PLEASE NOTE THAT ABOVE ESSENTIALS ARE SOLD ONLY TO MEMBERS OF THE LEAGUE—NOT TO NON-MEMBERS.

Send all orders for short wave essentials to SHORT WAVE LEAGUE, 98 Park Place, New York City.

If you do not wish to mutilate the magazine, you may copy either or both coupons on a sheet of paper.

SHORT WAVE LEAGUE, 98 Park Place, New York, N. Y.



G—15c for 25



F—25c each

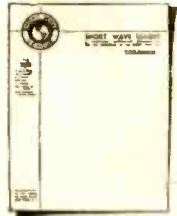

A—50c per 100



B—25c per copy

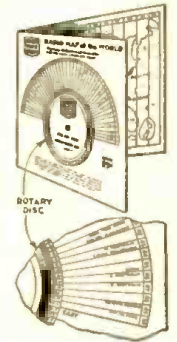

C—25c each



D—\$1.25 each



E—35c each

SHORT WAVE LEAGUE, 98 Park Place, New York, N. Y.

Gentlemen:

I am already an enrolled member in the SHORT WAVE LEAGUE

I am a new member and attach my application to this coupon

Please send me the following short wave essentials as listed in this advertisement:

.....

.....

.....

.....

.....

.....

.....

.....

.....

.....

.....

.....

.....

.....

.....

.....

.....

.....

.....

(4-33)



# Make Money With Short-Wave Sets

An Editorial by HUGO GERNSBACK

● THERE probably has never been a time as propitious as the present to sell the public short-wave sets.

During the past year, and right now, there is an avid demand for short-wave equipment of all kinds. This demand has not as yet been satisfied, and probably will not be for several years to come.

When broadcasting first started, during the radio boom between 1921 and 1925, everybody wanted to build a broadcast set. Millions of people actually built their own receivers.

The new generation of radio fans now coming along, particularly the younger people, instead of building broadcast sets, are out for "distance." Almost daily thousands are bitten by the short-wave "bug." Then too, the depression helps to keep people at home and, in the search for something to do, untold thousands are taking to the short waves for relaxation, amusement and instruction, as well as for education.

One thing is certain: there exists at the present time, and will exist for some time to come, a tremendous demand from the public for short-wave sets, converters and adapters. *This demand must be filled.* Usually, the man who starts in the game by himself has a hard hill to climb, and it is here that the experienced man, who already has mastered the intricacies of the short waves, comes in to make extra money, or indeed, to earn a living.

I have been astonished to see how alert the readers of SHORT WAVE CRAFT are and how they have actually been cashing-in on this demand during the past few months. Hardly a day goes by without one of our readers sending in a letter stating that he first built this or that set (which he saw described in this magazine), and, after it worked well, he demonstrated it to his friends and neighbors; then without trying to sell anything he was asked to build sets for others. One young man in the metropolitan district has built no less than forty sets to date for friends and acquaintances, and he is making a very neat profit. He also reports that, besides the sets he built himself, he also has sold a number of manufactured sets on which he was able to get a discount from the manufacturers.

## How to Sell Your S-W Sets

There is no doubt in my mind that thousands of our readers who have built sets can readily sell them if they go at it right.

Naturally, the easiest way is through friends and acquaintances, neighbors and the like. In small cities, the local newspapers will probably help along; because, if you explain to the editor frankly what it is all about, he will give you a small mention in the paper. Very often a real business results from this. Of course, not every local newspaper will feature the young budding genius who is building short-wave sets which reach the Antipodes, but in this case a small paid advertisement may help.

Another wide-awake young man tried a different method. He obtained permission from a department store on the main street of his community to demonstrate short-wave re-

ception from foreign countries. He had a number of telephone receivers connected in series to his set, which was, of course, home-built. People came all day long and listened to foreign stations. Quite a few sets were sold in this manner. A percentage of the sales went to the store in lieu of rent for the window display. This idea, it seems, can be worked with excellent results. Most drug stores, restaurants and the like have window space, and a few attractive window cards will call attention to what is going on.

## A Fine Chance for the Unemployed

Most young men who are interested in short waves these days have a good deal of spare time—many of them have no employment at all. It should be simple for most of them to cash in on the demand on short-wave sets and make a decent living almost immediately. As a rule, it takes only one demonstration to put over a sale; what counts, of course, is the actual "pulling-in" of a distant station. The rest is easy.

As to building the set, most of our readers will, of course, know how to go about it. The material is usually bought from the parts manufacturers or the radio mail order houses. Baseboards and panels can often be bought in your home town.

A few words of advice for the entire procedure will not be amiss at this point. First and most important, because everything depends upon it, is 100% neatness. A sloppy set will not sell others; neat wiring, well soldered, with the components placed in a geometrical or neat design, helps enormously. The wiring should be as neat and straight as possible. If the sets have the earmarks of being home-made, people will not buy them so readily. You should stress the idea that the receiver which you are trying to sell is not in the home-made class, but is CUSTOM-BUILT. Try to convince the buyer that you are a radio craftsman, that you take your work seriously, and that you take pride in turning out a fine job. This will make for confidence.

## Watch the Finish on Set!

The finish on the set should be A1. Holes should be drilled right; the instruments should be mounted straight, not lopsided. What you are trying to do is to imitate the appearance of factory-made set as much as possible, and even try and go it one better, which you may find hard to do.

There are some people who would not touch a custom-built set, no matter how low the price. Usually people who have some money will want a factory-built set; and, of course, you should not try to discourage this idea. The reason is that you can make a good profit from such sets just as well as if you built the set yourself. Most radio manufacturers are willing to give you a good discount; and the chances are that you will make more money on the factory model than you can make on your own. To those people who have not as much money to spare, the custom built model will probably appeal more strongly.

**SHORT-WAVE CRAFT IS PUBLISHED ON THE 15th OF EVERY MONTH**

This is the April, 1933, Issue - Vol. III, No. 12. The Next Issue Comes Out April 15th

Editorial and Advertising Offices - 96-98 Park Place, New York City

# RADIO ON ULTRA

By MARCHESE GUGLIELMO MARCONI, G.C.V.O.



On board the "Elettra": An unusual portrait of Marchese and Marchesa Marconi on board the yacht "Elettra." They have a baby daughter.

● THE Study of what may be termed "very short" waves dates from the discovery of electric waves themselves, that is, from the time of the classical experiments of Hertz and his contemporaries some 42 years ago.

In many of these experiments Hertz used very short electric waves, and conclusively proved that these waves fol-

The world has been waiting for a word from the master radio genius, Guglielmo Marconi, concerning his latest experiments and the results obtained with radio transmission on the ultra short waves. The editors are happy indeed to present herewith Dr. Marconi's own personal description of the experiments on ultra short waves, which have been heralded many times in brief newspaper reports from Europe, but this is the first authentic presentation of the technical facts describing the type of circuits and apparatus used.

lowed the same laws as waves of light as regards speed of propagation, reflection, refraction and diffraction.

### 38 Years Ago

The problem of utilization of very short waves for wireless communication is not a new one to me, for I have devoted to it much thought and labor since the time of my earliest wireless experiments 38 years ago.

In 1896 I was able to demonstrate to the engineers of the Post Office that waves of the order of 30 centimeters—corresponding to a frequency of approximately 1,000,000 kilocycles, and now sometimes termed "micro-waves"—could be successfully used for telegraphic communication over a distance of  $1\frac{1}{4}$  miles by employing suitable reflectors. Later this distance was increased to  $2\frac{1}{2}$  miles.

In 1916, war requirements called for methods of radio communication more secret than those which were then in use, and reopened the interest of the directive properties inherent in the very short waves, and I again turned my attention and investigations to the generation and reception of very short waves.

At that time, using special spark transmitters and a 2-metre wavelength, 6 miles of reliable communication was secured; and later tests with the same wavelength, carried out at Carnarvon, gave good signals at a distance of over 20 miles, with the indication that a greater range would have been possible.

Electromagnetic waves under one metre (1 metre = 3.28 ft. 1 centimeter = .39 inch) in length are usually referred to as "quasi-optical" waves, the general belief being that with them communication is possible only when the two ends of the radio circuit are within visual range of one another; and that consequently their usefulness is defined by that condition.

*Long experience has, however, taught me not always to believe in the limitations indicated by purely theoretical considerations or even by calculations, for these—as we well know—are often based on insufficient knowledge of all the relevant factors, but, in spite of adverse forecasts, to try out new lines of research however unpromising they may seem at first sight.*

It was about eighteen months ago that I decided again to take up the systematic investigation of the properties

and characteristics of these very short waves.

At the beginning of our work a choice had to be made between two alternative ways of attacking the problem—by the magnetron or the electron oscillator.

### A Tempting Road

As a powerful transmitter was the principal aim, the magnetron road was a very tempting one; but the necessity of employing rather high potentials, of producing an auxiliary field, and doubts of being able to ensure good modulation, made us prefer the Barkhausen-Kurz effect.

Not less important was the choice of the wavelength to be employed. Since it appeared improbable that there would be any great difference in the propagation properties of waves of, say, 80 to 20 centimetres, we decided first to concentrate our efforts on the generation and efficient radiation of what may be termed a medium wavelength on the micro-wave scale—that

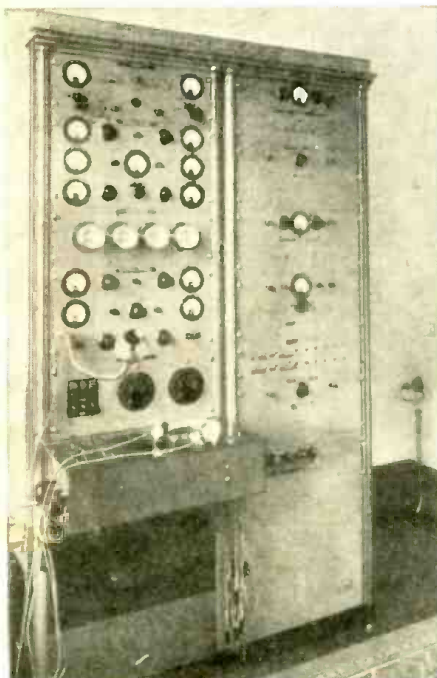

Fig. 6. Remote control of ultra short-wave transmitter which is giving a regular service between the Vatican City and Castel Gondolfo.

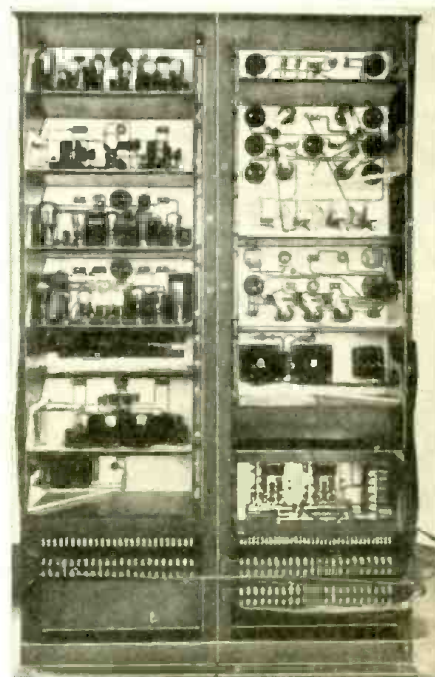

Fig. 7. Back view of the remote control switchboard of the Vatican City-Castel Gondolfo ultra short-wave transmitter.



# SHORT WAVES . . .

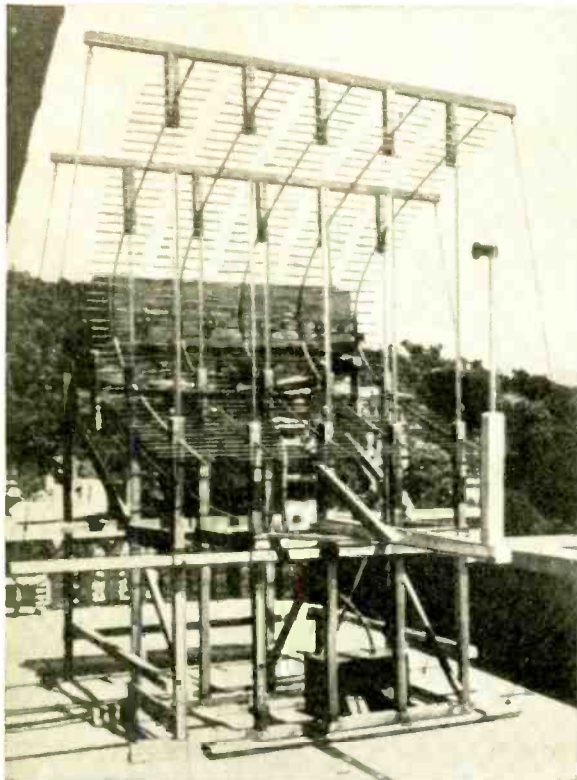

Fig. 8. Five-unit reflector four-unit transmitter used for long-distance tests on the ultra-short waves. They work in phase side by side.

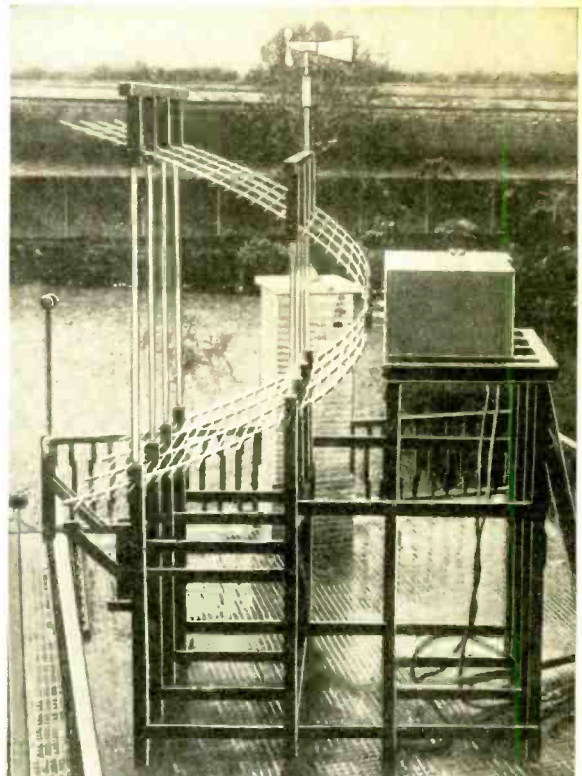

Fig. 4. This photograph gives a good idea of the herring-bone construction of the reflector used for ultra short-wave transmissions.

is, a wavelength of the order of .5 metre (600,000 kilocycles).

The first circuit tried was of the well-known Barkhausen and Gill Morrell plate-grid Lecher-wire type, which has been used in nearly all recent experiments.

### Cylindrical-plate Tubes

In that circuit we tried—with varying success—all the new and obsolete receiving and amplifying tubes of the cylindrical-plate type that were available; but as soon as they were pressed for power, their life proved to be only a matter of minutes.

Our efforts were therefore directed towards the production of a more suitable tube; and after a time a tube with

a 4-ampere tungsten filament and a molybdenum grid supported by electrical welding on molybdenum was produced, which led to a great improvement so far as the power obtainable and the life of the tube were concerned.

However, the inadequacy of the plate-grid Lecher circuit was soon apparent, and a new symmetrical two-tube circuit was thought out, and tried after two special tubes—the mirror images of one another—had been constructed for it.

The development of this new circuit has led to the present new transmitting circuit, and is shown in Fig. 1.

### New Electronic Oscillator

This new electronic oscillator is characterized by three definite tuned circuits, namely, an inside and outside filament-tuning and a plate-tuning circuit, and also by the use of a feeder-impedance transformer, the purpose of the latter being to match the internal resistance of the tubes with that of an efficient dipole aerial. These various circuits are indicated in Fig. 1.

The small discs at the end of the dipole aerial are acting as end capacities, and our experience has definitely indicated that their use secures more

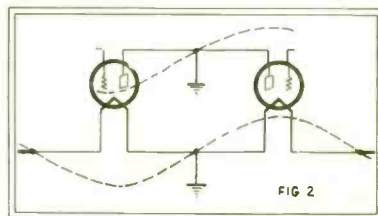
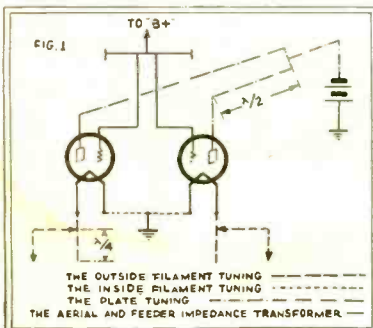
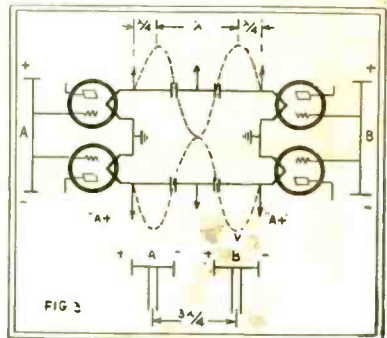

Fig. 1. The latest type of Marconi transmitting circuit for use on ultra-short wavelengths. Special tubes have been developed.

Fig. 2. Distribution of potential along filament and filament-tuning and plate-tuning circuits of ultra short-wave transmitter.

Fig. 3. This diagram illustrates the method of keeping in step two unit transmitters, spaced three-quarters of a wavelength apart.





This interesting portrait of Marchese Marconi was taken in his study on board the yacht "Elettra," which has been the scene of many important radio developments.

radiated power and renders easier the adjustment of the feeder-impedance transformer than is otherwise possible.

The plate tuning and the inside-filament tuning are the most important of all; in fact they are the controlling factors of the wavelength at which the transmitter can be made to oscillate with efficiency, all the other adjustments being dependent upon them.

It is necessary to point out that the correct length of conductor required to connect the two plates together to secure plate tuning is very small—it is only about 5 centimetres for a wavelength of the order of 50 centimetres—and the explanation of the fairly long kind of Lecher wire, shown in the above diagram, is that it has been found possible and also desirable to add to that short conductor another conductor one wavelength long, bent back on itself to avoid loss by radiation.

The action of the plate tuning is easily followed. It controls the frequency of the oscillations in a manner analogous to a straight steel bar vibrating with its middle point fixed.

This is really the case, since by connecting a thermo-couple in the middle of the tuning-plate conductor and leav-

ing the other connections free, the two plates and the conductor behave like a dipole aerial terminated by large end capacities.

The inside and outside filament tuning might at first appear to be acting only as effective chokes, but in fact both are necessary to ensure the correct distribution of potentials along and between the elements of the new circuit.

The correct distribution of the potential along the plate and filament circuits, obtained by these tunings, is shown in Fig. 2.

Of course, it is not sufficient to tune correctly all the external portions of the new circuit; it is necessary also to adjust the electrical supplies to the tubes employed to generate electronic oscillations between their electrodes to a frequency corresponding as closely as possible to that to which the external circuit is tuned.

The degree of filament heating is another important factor upon which the efficiency of the transmitter depends and naturally, the development of the tubes has proceeded parallel with that of the circuit.

**Tube Details**

The filament thickness in the tubes, the diameter and pitch of their grids,

and the length of their plates and grids were successively varied until the best results were obtained. The method of supporting the electrodes was also investigated and found to be a matter of importance.

The radiated energy of one standard unit transmitter has been measured by placing the whole apparatus—except the aerial and feeder—in a calorimeter and taking temperature curves first with the transmitter in oscillation, and then in non-oscillating condition, all the electric currents being kept constant.

Consistent results were obtained by this method, indicating an average radiation power of 3.5 watts.

The power absorbed by the filament is approximately 30 watts, that by the grid approximately 25 watts, the overall efficiency being, therefore, about 6 per cent, increasing to 14 per cent, if the grid power only be taken into account.

**Transmitters in Parallel**

The possibility of substantially increasing the radiating power of a transmitter was successfully realized by running several of these unit transmitters in parallel with their aerials all in line and spaced so as to secure the maximum directive effect.

The keeping of these unit transmitters electrically in step has been rendered possible by linking up, two by two, the outside filament tuning of adjacent transmitters by means of phasing links 1½ wave-lengths long.

Fig. 3 shows the schematic diagram of the arrangement for parallel working. It will be noticed that condensers are placed at the maximum current points, in order to permit of the independent regulation of the filament-heating current of each tube, the same principle applying in the case of four transmitters.

**Modulation Methods**

There are several ways of modulating the new transmitter, the principal methods being to super-impose the modulation on the grid high-tension positive D.C. supply, or on the plate steady bias negative potential.

But there are many other ways such as push-pull action on the plate or the grid, or even push-pull between two transmitting units. All these methods were tried and their peculiar characteristics ascertained, but the plate modulation was adopted at least for the time being, on account of its simplicity.

In the case of several transmitting units working in step, all the plate circuits are connected in parallel and are consequently modulated simultaneously.

*(Continued on page 745)*

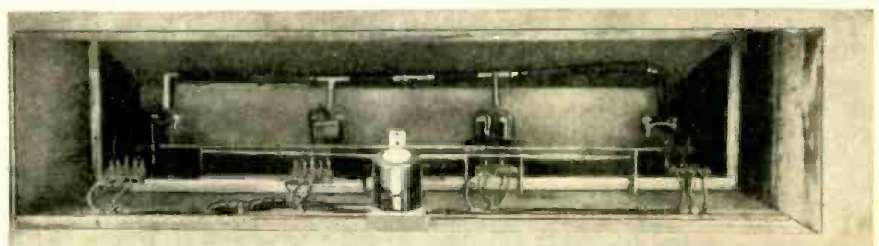
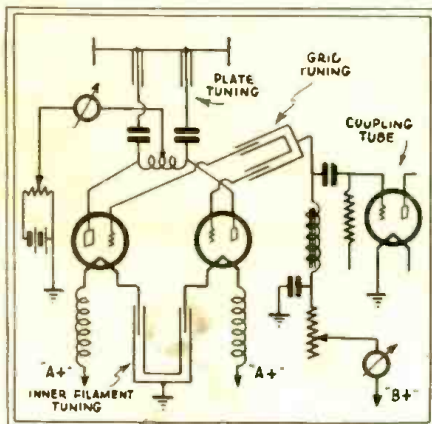
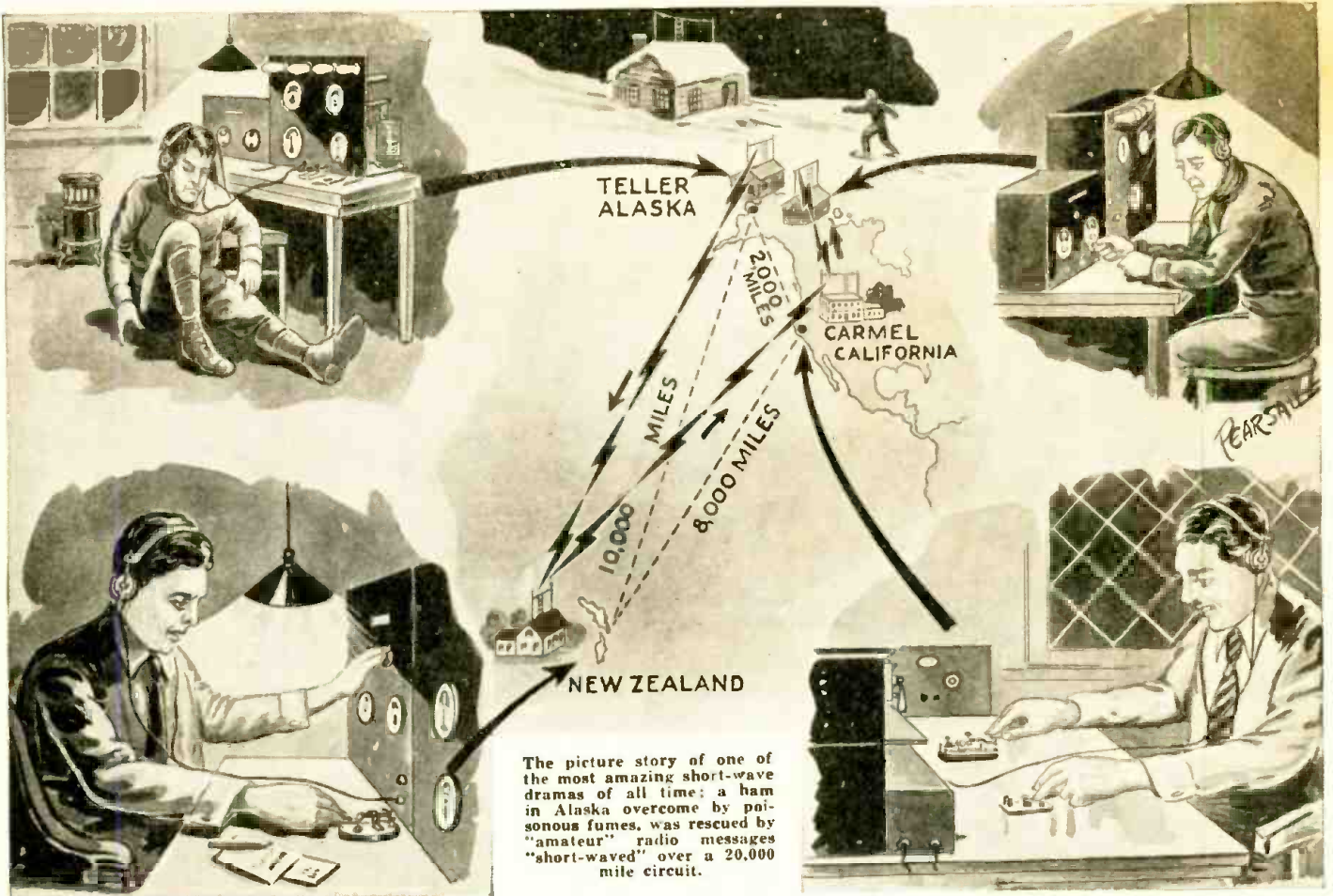

Fig. 9. Photograph of the four-unit transmitter used in conjunction with the reflector system illustrated in Fig. 8.

Left: Fig. 5. Schematic diagram of the latest Marconi receiving circuit for ultra short-wave operation. It should be noted that the filament circuits are tuned, as well as the plate and grid circuits.



The picture story of one of the most amazing short-wave dramas of all time; a ham in Alaska overcome by poisonous fumes, was rescued by "amateur" radio messages "short-waved" over a 20,000 mile circuit.

## HAM'S Life Saved by 20,000 Mile Code Flash

● A REMARKABLE rescue by short-wave radio was effected a short time ago, which involved four amateur radio stations scattered half way over the earth. Clyde Devinna, famous movie camera man and chief operator for Metro-Goldwyn-Mayer, was communicating by short wave radio with another amateur operator in New Zealand. Over the gaping 10,000 miles of space, Clyde Devinna was rattling his key in fine shape, when suddenly the code signals ceased! In the unusual cut off in the flow of code signals which followed, the operator in New Zealand sensed danger and that something was radically wrong.

He instantly started flashing the following radio distress signal:

"Come in—come in—any Pacific Coast amateur—please answer—emergency!"

Eight thousand miles away, across the broad Pacific in Carmel, California, there was another short wave "ham," who happened to be listening in at the moment—Colonel Claire Foster, millionaire radio amateur of Carmel. Colonel Foster was surprised to learn that danger was threatening his old friend, Clyde Devinna, way up north in Alaska. Yes, his friend, Devinna, lay unconscious in that Alaskan shack, with the snow banked up to the windows and the thermometer 50 below zero.

The next act in this startling short-wave drama took place in the space

"Ham" overcome by gas in Alaska is saved by code signal flashed from New Zealand to California and back to Alaska, a "20,000 mile radio rescue."

of a few moments. Colonel Foster started calling "ham" radio stations in Alaska—2,000 miles to the North. Thanks to the Colonel's powerful amateur radio transmitting set, he had soon "raised" an amateur station at Teller, Alaska, the same town in which Clyde Devinna lay unconscious in a gas-filled shack.

The Alaskan amateur, who heard Colonel Foster's astonishing dot and

dash message, hastily donned furs and snow-shoes and made his way to Clyde Devinna's shack. He smashed in the door and dragged Devinna to safety. Devinna was the victim of poisonous fumes given off by a gasoline heater, which due to the small amount of air in the shack, soon poisoned him sufficiently to overcome him.

### German U. S. W. Television

The German ultra short-wave television transmissions take place at irregular hours with a 300 watt transmitter on a wave-length of 6.74 meters or a frequency of 44,480 kc. The transmissions are at 60 lines and a sequence of 25 pictures per second. The latter figure will likely be applied in the future by all German television senders, inasmuch as also the movie film works at this speed and the use of films on television transmitters is contemplated even at this early date on a large scale.

The Döberitz transmitter of the Reichspost Zentralamt (German Post Office Department) also works with a frequency of 25 pictures per second; however, only with 48 lines. The transmitting for some time now has been on 142.9 meters or 2100 kc., usually every day between 9:30 to 11:30 p. m. In the event of transmitting talking movie films, the voice will be emitted on 92.31 meters or 3250 kc.—Radiowelt.

**Many New Sets are  
Going Through our  
Laboratory!**

**Several of these will  
be described in the  
next issue**

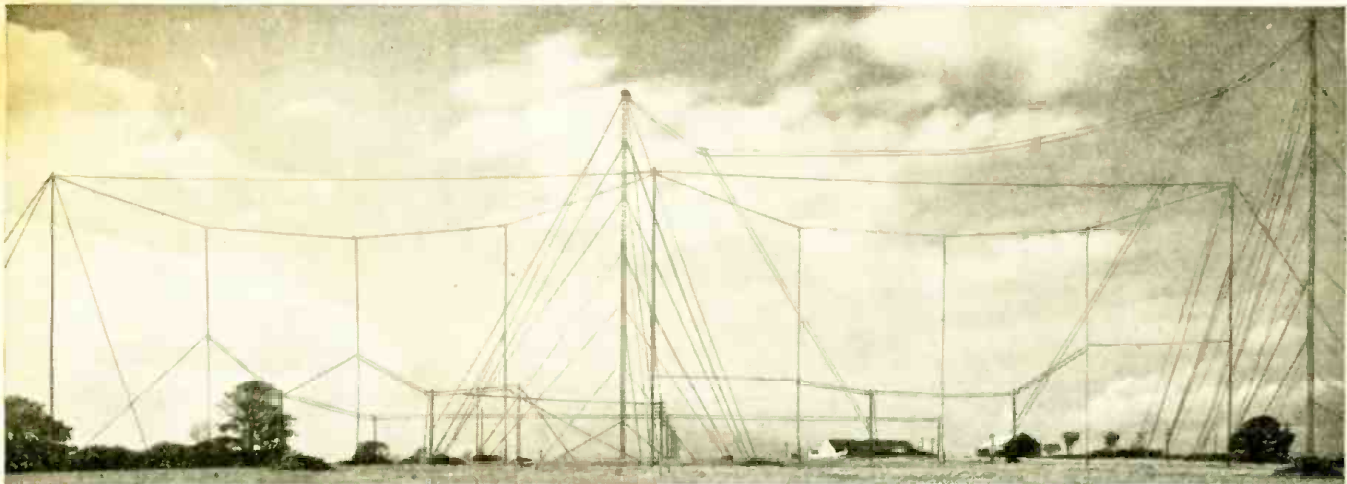

# The New DAVENTRY Station

New British S-W broadcasting station at Daventry. The six "uni-directional" aerials, with the two latticed masts and the Empire station building in the background.

England's new short-wave station at Daventry, is known as the Empire Transmitting Station; and is reported coming in very strong in this country.

● THE new Empire Transmitting Station was recently put in operation at Daventry, England, and has been reported by many readers of *SHORT WAVE CRAFT* as coming in with very little fading and great signal strength in this country, is one of the most powerful in the world. In a recent article in *World Radio*, to whom we are indebted for the accompanying information and photos, it is stated that most probably the majority of programs radiated from the Empire Station will originate in London; they will reach Daventry via the Control Room at

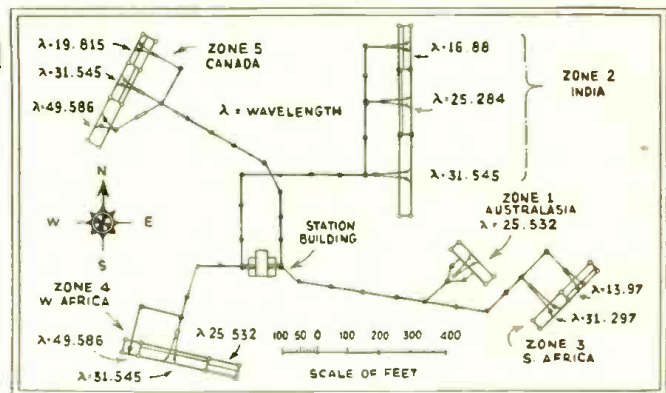

Above—ground plan of the directional antenna arrangements at Daventry, where the powerful short wave beams are hurled to distant climes.



Empire S-W broadcasting station at Daventry. Top—View of whole transmitter; Lower view, inside of a power output stage taken from back.

Broadcasting House. But programs can also be taken from other centers such as Birmingham, Manchester, etc., by means of telephone land-lines which link the various centers.

The control rooms are acoustically treated and contain loud speakers; headphones can also be used, if necessary. All of the amplifiers in the control and monitoring departments are sup-

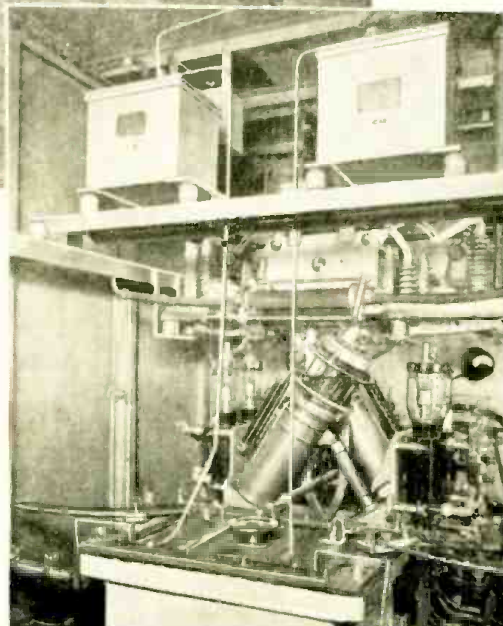

plied with current direct from the A.C. power circuit at 415 volts and 50 cycles. Parts of the power supply equipment at the new Daventry station comprise boiler, engine and dynamo power rooms, together with a special tube water-cooling plant. In order that different wavelengths may be used as seasonal changes require, etc., each short-wave transmitter was designed to work on different wavelengths between 14 and 50 meters and furthermore they are arranged so that changes from one wavelength to another can be made in the minimum amount of time. The panels of the instrument cubicles are of black slate; the panels are screened from the transmitter components in the cubicles by duralumin screens fixed to the back of each panel.

In order to preserve a constant frequency, the frequency of each master oscillator tube is controlled by a quartz crystal, a separate crystal being employed for each wavelength used. A series of frequency doubling stages are employed so that crystals of fairly low frequency can be utilized on wavelengths below 17 meters. The crystal frequency is doubled three times, thus giving an overall multiplication of eight times, so that the crystal used for any particular wavelength oscillates at one-eighth of the transmission frequency. On wavelengths above 17 meters, one or two doubling stages are used. Each crystal is housed in an asbestos-in-

(Continued on page 744)

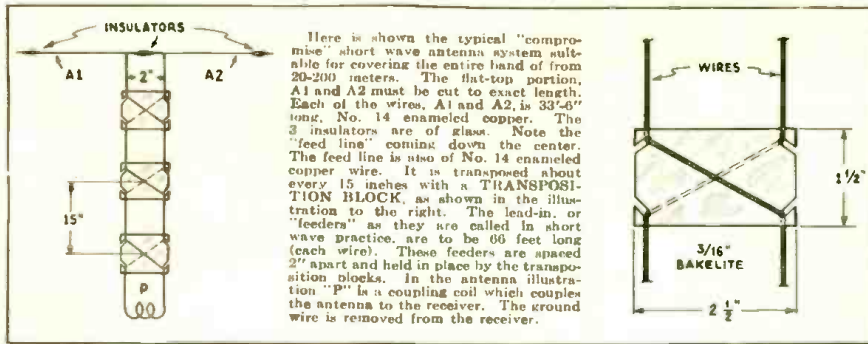

Here is shown the typical "compromise" short wave antenna system suitable for covering the entire band of from 20-200 meters. The flat-top portion, A1 and A2 must be cut to exact length. Each of the wires, A1 and A2, is 33'-6" long. No. 14 enameled copper. The 3 insulators are of glass. Note the "feed line" coming down the center. The feed line is also of No. 14 enameled copper wire. It is transposed about every 15 inches with a TRANSPOSITION BLOCK, as shown in the illustration to the right. The lead-in, or "feeders" as they are called in short wave practice, are to be 66 feet long (each wire). These feeders are spaced 2" apart and held in place by the transposition blocks. In the antenna illustration "P" is a coupling coil which couples the antenna to the receiver. The ground wire is removed from the receiver.

# Some Things You Don't Know About S-W Aerials

By DON C. WALLACE

● FEW people realize what a pronounced improvement in reception is had from the use of a properly designed short-wave antenna system. It must be correctly laid out, correctly built and correctly installed in the proper place.

The best location for an antenna is on or over vacant property. A "back lot" antenna is superior to one that is stretched across the housetops. The unusually large network of house-wiring, all of which is directly, inductively or capacitatively coupled with all of the electrical devices in the city, picks up noises which are inherent in the wiring system but which are not picked up a few yards distant.

Too many treatises on antenna systems deal with the subject in a vague, general manner. Actual dimensions are left to guesswork. This article gives exact dimensions, their importance being such that the success of short-wave reception depends upon them to a greater extent than the average experimenter is aware of. A surprisingly large number of new stations

Several surprising facts concerning short-wave aerials are given in the accompanying article by Don C. Wallace, one of the best known short-wave experimenters in the country. If you want the best S-W aerial, it should be constructed with very heavy copper wire, such as No. 6, 8, or 10, with No. 12 for the feeder system. Furthermore, bare copper wire starts to corrode on the surface within forty-eight hours after erection and its efficiency is therefore impaired at the very start. Enameled wire or the new Chromoxide is ideal for the purpose. Reception noises can be mostly eliminated by using a transposition feeder system from the antenna to the receiver. Also, solid wire is preferable to stranded cable for S-W aerials.

will be heard if the proper short-wave antenna system is used.

The dimensions and placement of the antenna are more important than the kind of wire used. The ideal antenna wire is that of the largest size, consistent with the ability to erect and permanently suspend it in the proper place. Conditions too often do not permit the use of large wire, neither will the pocket book afford it. A compromise must be made. Radio, in all its branches, is a compromise . . . between convenience, cost, time, ease of construction and operation, availability of material, knowledge of the subject, inherent inhibitions against things "new" or those that differ from the traditional. This article deals with the successful and practical compromise of antenna systems that are within the reach of all.

### The Size of Wire to Use

In order named are the practical sizes of antenna wire which are best suited for short-wave reception:

1. No. 6, No. 8 or No. 10 solid copper enameled wire for the flat top portion and No. 12 enameled wire for the feeder system.
2. No. 12 solid copper enameled wire for both the flat top and feeder system.
3. No. 14 solid copper enameled wire for both the flat top and feeder system.

Wire smaller in size than No. 14 is not strong, mechanically. It will not permit of "full stretching" when pulled taut. As a last resort No. 16 enameled wire could be used with perfectly satisfactory results. In general it is suggested that No. 12 wire be used for spans of more than 100 feet and No. 14 for spans of less than 100 feet. Enameled wire is the more practical to use. Radio frequency currents have a tendency to travel on the surface of the wire. Bright new copper wire would be best if it could be made to retain its shiny finish. The R.F. (Radio Frequency) currents travel with minimum loss on a bright surface, the antenna system radiates with greatest ease, and maximum efficiency is the result. However, corrosion on the surface of the wire will increase the

(Continued on page 756)

## Points to Watch when installing S-W ANTENNAS

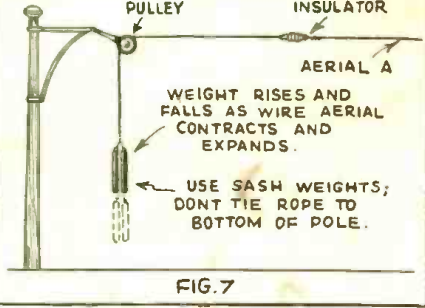
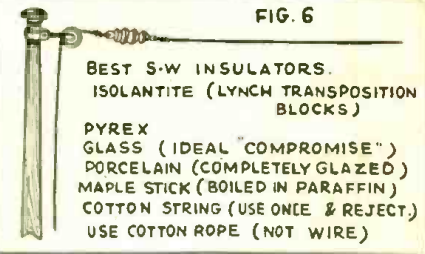
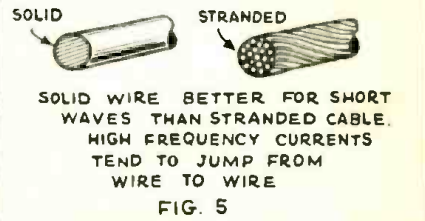
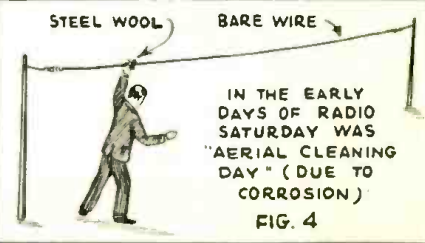
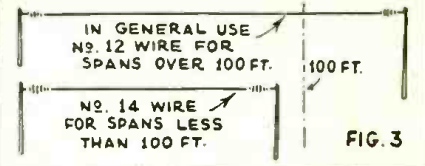
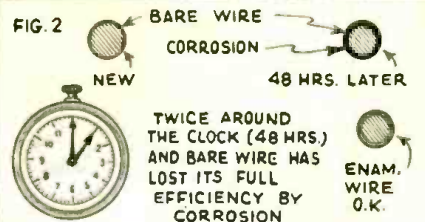
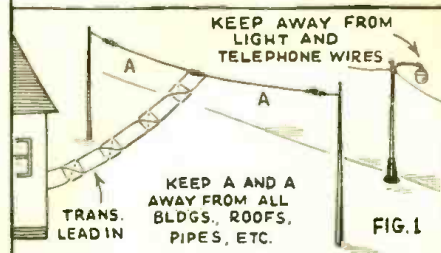

# The Cigar-Box 1-Tube "CATCH ALL"

By F. L. BATTLES



The Cigar-Box short-wave receiver here described is thoroughly portable and slides under your arm just like a Kodak, as photo at left shows.

Photo at right shows the "innards" of the Cigar-Box "Catch-All" receiver with headphones.

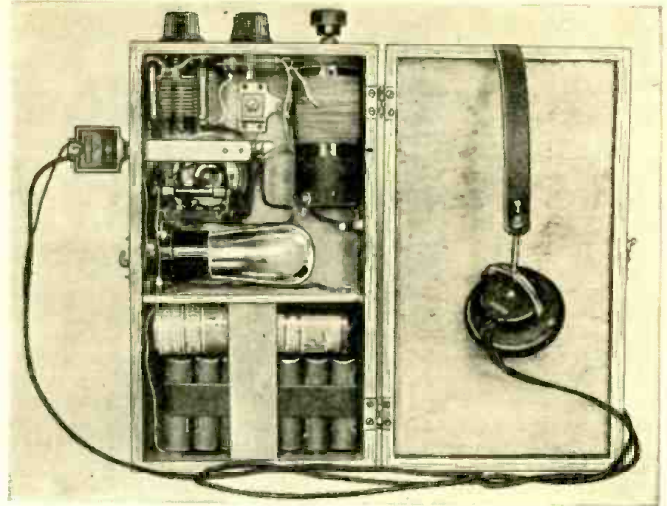

This pocket size receiver employs a standard short-wave circuit with several innovations made by the author. He has arranged the regeneration control in the form of a movable tickler coil; the different wave-bands are switched into or out of circuit by means of a home-made switch. A filament-control jack is advantageously employed.

● With two vital points in mind, a truly "Pocket Size Short-Waver" and one that any constructor with a deflated pocketbook can build, I had a man-sized job on my hands.

A tapped coil wound on an old bakelite flash-light tube, with a tickler wound on an old tube base that slipped easily inside of the other and made movable from the panel with a 10/32" threaded rod, supplanted plug-in coils. With an inductance switch mounted on the panel it enabled one to quickly pass from the low to high wavelengths almost instantly. The "micrometer adjustment" gained by the unique regeneration control was a job to operate.

As the thickness of the case was not to exceed 2 1/2", even the smallest commercial "B" battery was out. I use seven of the flat flash-light cells purchased at the 5-and-10 and wired in series. This gives 21 volts and from

former use of this type of "B" battery, I find that it will last at least six months with ordinary use. Two round flash light cells, a type 30 tube, and a 20 ohm rheostat mounted inside the case and set at the best operating voltage, takes care of the "power plant."

A 23 plate Pilot midget condenser (.0001 mf.) is used to tune the coil. All controls are mounted on one end of the case so that the midget can be slipped readily into an auto side pocket, overcoat, etc.

I find with the variable tickler method of controlling regeneration that a R. F. choke is not necessary at all. I have eliminated switches by using a filament control jack. This, incidentally, protects accidental drain on the batteries. By use of little round head brass brads, I have marked off the dials for ease in tuning.

Here is my method of making the

cover fit on my case. First, assemble the two ends and top and bottom, using good glue and fine brads. When the glue is set then apply the two sides in the same manner. Allow several hours for the glue to set. Now, mark off where you wish to fold back the lid and split the case with a fine saw. This will give you a perfectly fitting top for your case as it was all built in one piece.

I have had excellent "daylight reception" with the little set. One that I have built with two stages of audio added, gives uncomfortable ear phone volume, and works a loud speaker for everything but the weakest stations.

There are hundreds of boys and men who are anxious to join the army of short-wave listeners and they can now do it for a very modest outlay, as practically all of this job is home-made or from parts secured at the local chain

(Continued on page 759)

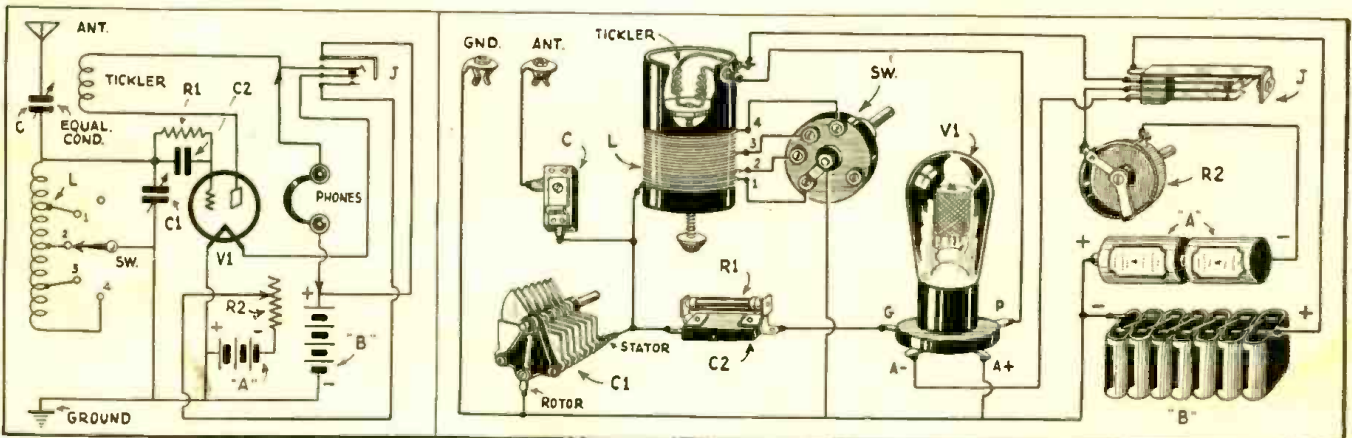

Wiring diagram showing how Mr. Battles connected up his Cigar-Box "Catch-All" Receiver.

For the uninitiated, we are glad to give above a picture diagram which simplifies matters considerably.

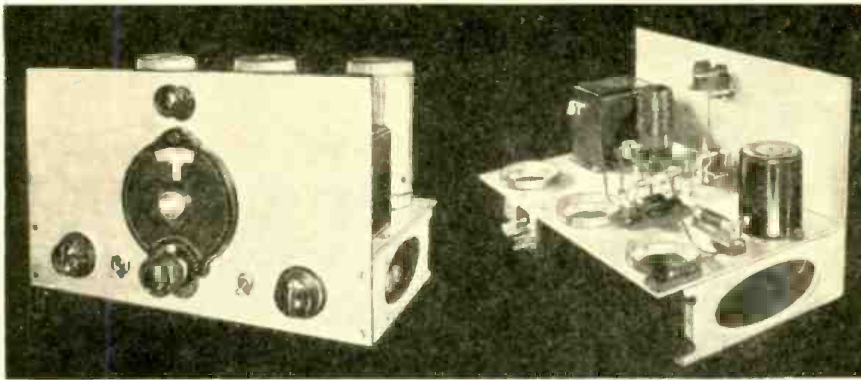

Front and rear views of Mr. Myers' receiver—the arrangement of the parts has not been changed from the original design but the new 57 and 58 type tubes have been incorporated.

Mr. Myers described his original 3-tube short-wave receiver in the October number of SHORT WAVE CRAFT. The receiver at that time was considered an efficient and up-to-date job, but in the meantime the new 57 and 58 type tubes have made their bow and the author has incorporated these new tubes in the circuit of his receiver. He also uses an electron-coupled detector. The output obtained with this little receiver is really surprising and with only four feet of antenna wire, the volume on most signals is too great for phones.

# Mr. Myers Modernizes His 3-Tube S-W Receiver

By I. O. MYERS,  
Physics Dept. West  
Virginia University

● In the October 1932 issue of SHORT-WAVE CRAFT an article appeared describing a three-tube short wave receiver which used two type 35 tubes and one type 47 tube. At that time this receiver was thought to be about as effective as it was possible to be, using those tubes and a single tuned circuit. Since the announcement of the types 57 and 58 tubes, this receiver has been rebuilt and greatly improved.

The first stage, which was an untuned radio frequency amplifier, was not changed much, except to adapt the circuit to a type 58 tube. The new tube is a much better R. F. amplifier than the 35. The coupling to the detector is inductive.

### Electron-Coupled Detector

Perhaps the most important thing about this receiver is the *electron-coupled* detector. This form of detector is especially suitable to code reception but works very well on broadcast reception also. This detector, in an oscillating condition, provides an extremely stable oscillator, which is not affected seriously by changes in plate voltage. The result is that code signals take on a new steadiness not obtainable with other detectors. Blocking does not occur readily.

### Regeneration Control Features

In using the 57 it is found to give great sensitivity when used with a high screen voltage. Since regeneration is controlled by the voltage on the screen and the number of turns in coil L3 and a high voltage is desired on the screen, it is necessary to keep the number of turns on L3 a minimum and still be able to make the detector oscillate. It is very important that these facts be considered or the full sensitivity of the 57 will not be realized. It is not difficult to make the detector oscillate in this circuit; in fact, one turn is sufficient for the 20, 40, and 80 meter bands. The spacing of this coil can be adjusted until oscillation occurs with 90 volts on the screen. The regeneration control R6 should be turned to the right about as far as it will go for this adjustment and the coil

spaced up or down until the detector just oscillates. Coil L3 is wound in opposite direction from L4. Even higher voltages than 90 volts may be used on the screen, but the detector may become too sensitive and howling will result.

### Shielding of Tubes Desirable

The R. F. by-pass condenser C4 and the R. F. choke are very necessary and contribute much to the stability of the receiver. However, C4 must not be made too large or a serious loss of volume will occur. Any value from 40 micro-microfarads to 100 micro-microfarads will do nicely. Shielding of the tubes is desirable.

The audio stage is very simple and used a type 47 tube. It is coupled to the detector by means of a National Type S-101 inductor. If more than

135 volts are used on the 47 it is desirable that some form of coupling device, such as an output transformer, be used between the 47 and speaker.

The heaters of all three tubes are wired in parallel and are fed by a 2½ volt transformer. A power-pack supplies the plate power, or batteries may be used if desired.

The output of this little receiver is really surprising. With only four feet of antenna the volume on most signals is too great for phones. As before, the Aero Hi-Peak is included, but it may be omitted unless great selectivity on code is desired.

*A word or two in reference to the best form of coupling the output circuit to the 47 pentode will not be amiss. In the R. C. A. Radiotron Manual the following important information is given: Any conventional type of INPUT COUPLING may be used provided that the resistance added to the grid circuit by this device is not too high. Transformer or impedance coupling devices are preferable. If input resistance coupling is used, a grid re-*  
*(Continued on page 755)*

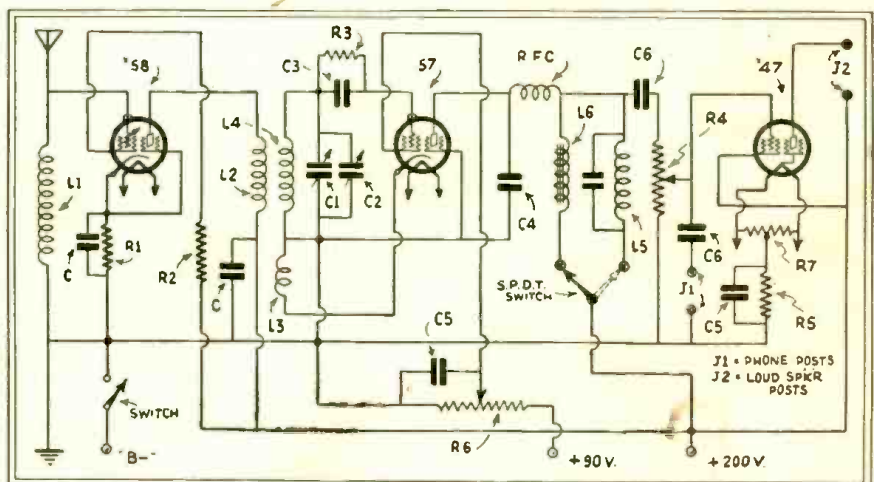

Diagram showing the new connections devised by Mr. Myers for use with the 57 and 58 type tubes, in his excellent design of a 3-tube receiver.

# An All-Purpose Receiver

By J. W. CULLEN, W9CIN

This instrument may be used as a portable receiver, test oscillator, wavemeter, monitor, modulated oscillator, or even as a small code or phone transmitter.

● HOW many times have home set builders, experimenters, "hams" and "tinkers" wanted a portable receiver, a test oscillator, a wavemeter, a monitor, a modulated oscillator, or even a small transmitter (code or phone)? That's a pretty big order for the fellow of moderate means, especially in these times. The writer (incidentally, among those of moderate means) wanted all of those—and got them, and, strangely, got them at even lower than moderate price. What is more, he got them all into one unit, a very practical and workable unit, and one small enough to be quite portable.

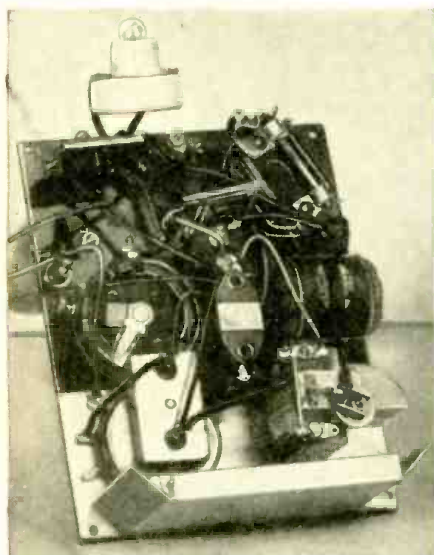

Another view of Mr. Cullen's versatile short-wave receiver, which is here being used as a wavemeter, with a small battery lamp as a resonance indicator.

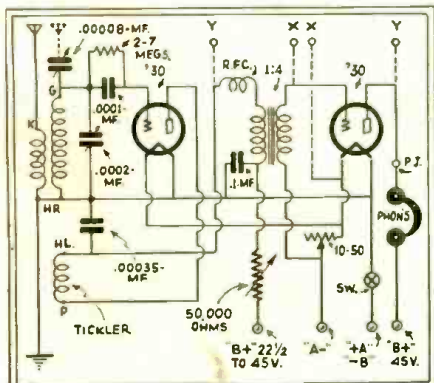

Simple connections used in Mr. Cullen's Short-Wave Receiver, which can be used for most every purpose met with by amateur radio operators.

This all sounds queer, but the unit is being used at the present time by the writer and he finds it one of the handiest tools he has ever used and one for which he has far more uses than he contemplated when he constructed it. The job started out as a "portable" short-wave receiver and as the various uses were demanded the evolution took place. The saving in money will be obvious as soon as you see what it really can do.

## Set Housed in Small Cabinet

The set proper is housed in a small wooden cabinet 5" x 6½" x 2½" inside dimensions. If such a cabinet cannot be found, one may be constructed from cigar-box wood. Only two tubes of the 30 type are used. The accessories are a set of plug-in coils, a small 45 volt "B" battery, headphones and two flashlight cells in series, also a wafer adapter (phonograph type) giving external access to grid and filament of the audio tube. This adapter is slipped on over the tube prongs and the tube plugged into its socket. The last accessory can be made; it is a four or five-inch piece of wire with a phone tip on one end and a small battery clip on the other.

## Hints on Use

The diagram and pictures tell nearly all the story but a few notes on the different uses will help. As a receiver the connections are obvious and standard (see diagram). The antenna connection may be either a primary on the coil or a built-in series condenser to the grid coil. Incidentally, the antenna leads are connected to Fahnestock clips mounted on the machine screws which hold the coil and one tube socket to the panel. Stations come in with good volume and regeneration is smooth.

Five plug-in coils cover the wavelength range between 14 and 600 meters. There is another plug-in using small radio frequency choke coils to convert the receiver into a test oscillator for superhet intermediate frequency amplifier alignment.

## As a Test Oscillator

As a test oscillator, use the set as an ordinary receiver in oscillation. Coupling to the device under test may be accomplished by mutual induction, or capacitively by using the antenna condenser as the coupler. For wavelengths up to 600 meters use the same coils as though to receive signals. For the intermediate frequencies of present day supers use the honeycomb coil (R.F. chokes) plug-in. If tickler connections are properly made they will oscillate readily. The coils are from 10 to 15 millihenries each and



The remarkably clever All-Purpose Receiver here described by Mr. Cullen, who explains how to use this instrument as a wavemeter, monitor, test oscillator, etc.

will tune to frequencies lower than 175 kc., thus taking care of all broadcast band "superhets" being built today. Intermediate frequencies not represented by the fundamental range of this coil can be obtained from harmonics, and excellent results can be obtained easily as far as the seventh. For instance, if the coil is oscillating at 175 kc., a fourth harmonic of 700 kc. is generated and made to cause a "squeal" with a broadcast station operating on that frequency. For 465 kc. intermediate frequency units either fundamental (232.5 kc.) or (155 kc.) may be generated.

For a modulated oscillator connections are made externally by using the wafer adapter which gives access to points "XX" in the diagram, constituting an unconventional Heising system, which works wonderfully well. A phonograph pick-up may be plugged into the adapter, or a buzzer and battery may be used, the buzzer being connected across "XX" so that buzzer and secondary of the audio transformer are in parallel. The detector tube must be in a state of oscillation.

Now the "clip-and-phone-tip" wire comes into use; remove phones from set and plug tip end of wire into the phone tip jack on panel, and attach clip to "HL" lug of the Pilot plug-in form. If these are not being used a clip cannot be used—just wrap a turn or two of the wire around the "HL" prong on the coil form and replace in socket, the idea being to tie together points "Y" and "Y" shown in the diagram. The audio tube then receives its "B" voltage through the primary of the audio transformer, which acts as a modulation choke, causing the plate current of the detector tube to rise and fall with changes impressed upon the grid of the audio tube. The quality of modulation is excellent.

## Used As a Transmitter

Used as a small transmitter, as the writer has done for local work, all connections are the same as for a modulated oscillator.

(Continued on page 754)



# HOW I LEARNED TO HANDLE CODE

with Speed and Accuracy



By **THEODORE R. McELROY**

Official Champion Radio Operator of the World

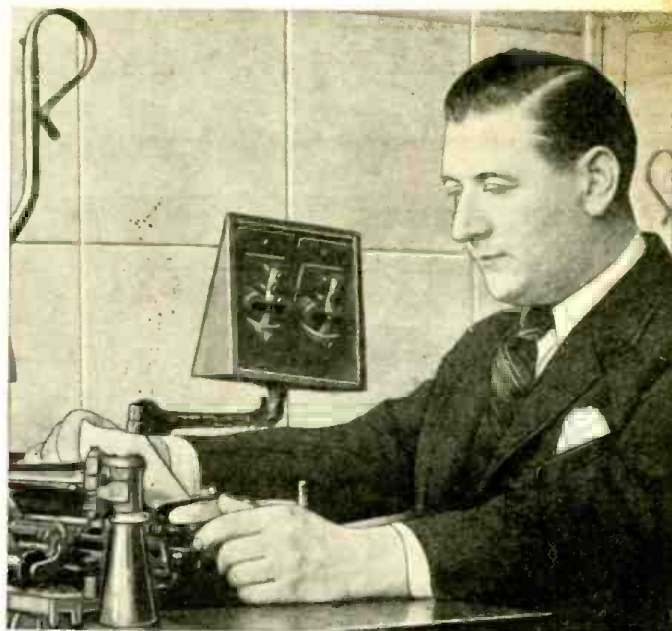

Theodore R. McElroy, official champion radio operator of the world, who has copied code at the tremendous speed of 56½ words per minute.

The embryo "ham" operator is indeed fortunate in having the privilege of learning a few tips on how to learn the radio telegraph code, so as to transmit with speed and accuracy, from the world's official champion, Mr. McElroy. Some little-known facts about accurate code work are here given by Mr. McElroy.

● SINCE having won the wireless or radio code championship for three successive years, I have received many thousands of letters from radio operators and code students from every country in the world wanting to know my methods of training for the code tournaments. Now, for the first time, I am writing for publication, giving some of the facts pertaining to my career as a radio operator and my experiences as a champion.

In that my accomplishments have been so closely associated with the principles taught by Walter H. Candler, originator of the Candler System for code students and radio operators, I must necessarily give at least a brief explanation of this system.

The mind of a code student is comparable to a phonograph record, which reproduces exactly the material that has been recorded on it. Should there be an error in this material, the phonograph will reproduce the error as faithfully as it does the correct material, and so long as the record lasts that error will appear.

For some reason, initial mental impressions always are the strongest, the most enduring. Should the beginning code student receive, as all too frequently happens, the wrong impressions with relation to the dits and dahs comprising Continental Code, he will, like the phonograph, reproduce them

just as faithfully as if they were correct. And, when these erroneous impressions are once received they are difficult indeed to eradicate; consequently, the student labors against a handicap which retards his progress. Personal contact with many aspiring code students during the past few years convinces me that a wrong beginning in this connection is the principal reason why the majority of code students find it very difficult to ever advance beyond the 8 to 10 words per minute class.

### Fundamental Training Necessary

I can send and receive code as easily as I talk or listen to some one else talk, and while it is seemingly natural for me to do so, I recall the time when I did not know a dit from a dah. My ability to copy code at high rates of speed, several words behind the sender, is not natural. While I undoubtedly was born with the capacity, like every normal human, I had to acquire the ability by first learning the necessary fundamentals—by obtaining the right impressions, and by persistent practice under the experienced supervision and personal instructions of my teacher. And, in this respect, I want to tell you I was most fortunate, and I should feel that what I say here would be of little value to you should I fail to give you the facts

as I know them from experience.

The all-important thing for the beginner is a thorough knowledge of the necessary fundamentals. The Candler System of training begins by defining these fundamentals upon which code accuracy and speed are based. The learning of code without this knowledge would be as difficult as trying to learn mathematics without a knowledge of the multiplication table. For example, Candler teaches the beginner that there is absolutely no space, that he can consciously allow, between parts of any code signal, with the exception of the period; that ditdah (. -) does not "stand for" A, but IS A. You must not translate. You must recognize the sounds, not as "standing for" certain letters, numerals or punctuations, but as BEING those signals. Now there is a reason for this which I shall amplify later.

Candler shows the student that if any perceptible space is allowed between parts of a signal, the signal will be something other than that for which it was meant; that is, A will be transmitted et; B, ts; C, nn; D, ti, and so on.

The philosophy of this method is appreciated when one listens in on any amateur band. Notwithstanding the fact that I hold the code receiving record, I find it very difficult to

(Continued on page 748)



**HIS TEACHER**  
W. H. Candler, the man who taught Mr. McElroy many of the tricks he knows when it comes to first-hand accurate code transmission and reception. Mr. Candler, director of the Candler System, knows just where the weak spots are in the embryo radio telegrapher's psychology and he has made a special study for many years as to just how a radio operator should learn the code; slowly and with iron-clad accuracy from the start. There is no royal road to learning the code if you really want to become an A-1 operator, known for your "speed" and "accuracy."



One of the code classrooms in the Candler School where the system which enabled Mr. McElroy to win so many records is taught.

# The "OSCILLODYNE" 1-Tube WONDER SET

By J. A. WORCESTER, Jr.



The 1-Tube "Oscillodyne" in actual operation. This is the set shown on our front cover.

This is the first of a series of articles on the "Oscillodyne" prepared by the inventor of the circuit, Mr. Worcester. The second article will appear in the next issue.

Part I.

● THE short-wave receiver which is described in this article depends for its operation on a principle which the writer believes is presented for the first time herewith. This receiver, while not presented as destined to replace existing methods of reception, is, nevertheless, in many respects the ideal receiver; particularly for the short-wave beginner or would-be beginner who is interested in obtaining the maximum "results per dollar" obtainable.

The fundamental circuit is shown in Fig. 1. A cursory examination will indicate that it is nothing more nor less than a simple oscillatory circuit. The feedback, however, is considerably greater than that required for the mere production of sustained oscillations, being of sufficient magnitude to produce *irregular oscillation*. This means that the oscillatory circuit is periodically rendered inoperative at a frequency dependent on the amount of feedback and on the value of the grid condenser and leak employed. In this receiver the oscillations are stopped and started at a super-audible frequency by proper selection of these

three constants as explained later. The manner in which such a circuit can be employed for the reception of radio frequency signals can be described as follows. In Fig. 1 is represented a high frequency disturbance of amplitude "A". If such a signal is present on the grid of the oscillator, this signal will build up as in Fig. 2B. In an ordinary oscillator, oscillations would build up to a value "B" (determined by the tube characteristics), as shown by the dotted lines of Fig. 2B. In this circuit, however, the feedback is too great to allow the electrons on the grid to leak off sufficiently fast to maintain a constant mean grid potential. The result is that the mean potential of the grid decreases, causing a corresponding decrease in the plate current as in Fig. 2C. As the plate current decreases the plate resistance increases, causing a decrease in the mutual conductance of the tube. Finally the plate current is reduced to a value "C" at which the mutual conductance is no longer sufficient to maintain oscillations and they die out as shown in Fig. 2B. The negative charge accumulated on the grid of the tube then leaks off at a rate determined by the time constant of the grid con-

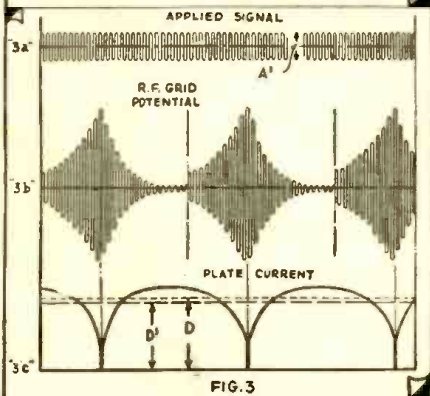
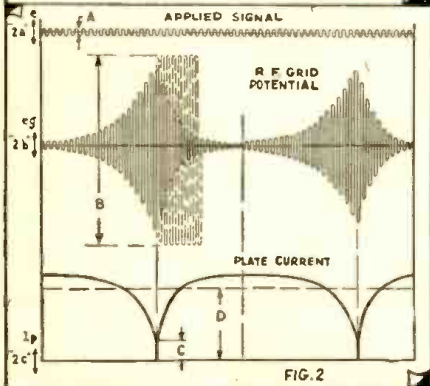
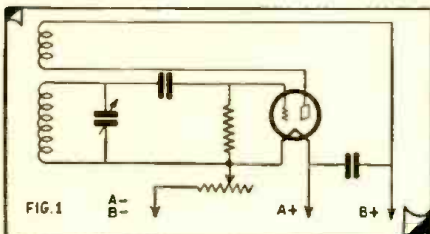

Graphic diagrams employed by the author in connection with the text to explain the interesting action taking place in the "Oscillodyne."

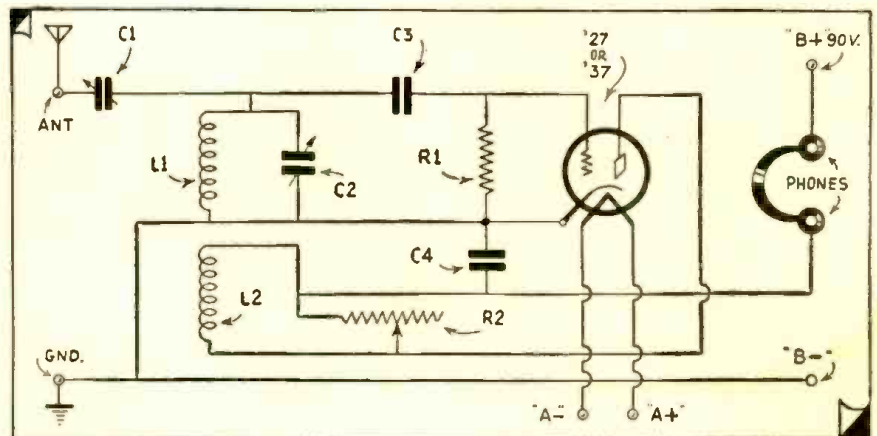

Schematic wiring diagram showing how to connect the few simple parts composing the "Oscillodyne."

A REALLY NEW CIRCUIT

**W**E are pleased to present to our readers an entirely new development in radio circuits.

Under the name of "The Oscillodyne," Mr. J. A. Worcester, Jr., has developed a fundamentally new circuit, and he describes the theory as well as the practical application in this article. This circuit, which is of the regenerative variety, acts like a super-regenerative set, although it does not belong in this class. Its sensitivity is tremendous.

The editor, in his home on Riverside Drive, New York, in a steel apartment building, was able to listen to amateurs in the Midwest on this simple one tube set, *using no aerial and no ground!*

With a ground alone, a number of Canadian stations were brought in, and with a short aerial of 40 feet length, many foreign stations were pulled in easily.

This circuit is certainly an epoch-making one which should find immediate acceptance by the entire radio fraternity. The circuit has the advantage that it is not tricky if good material and common sense are used.

The set was tested in different parts of the East, and it has been found that the results are satisfactory in practically every location.

In our own estimation, the Oscillodyne is one of the greatest recent developments in radio circuits, and the editors recommend it warmly to all readers.

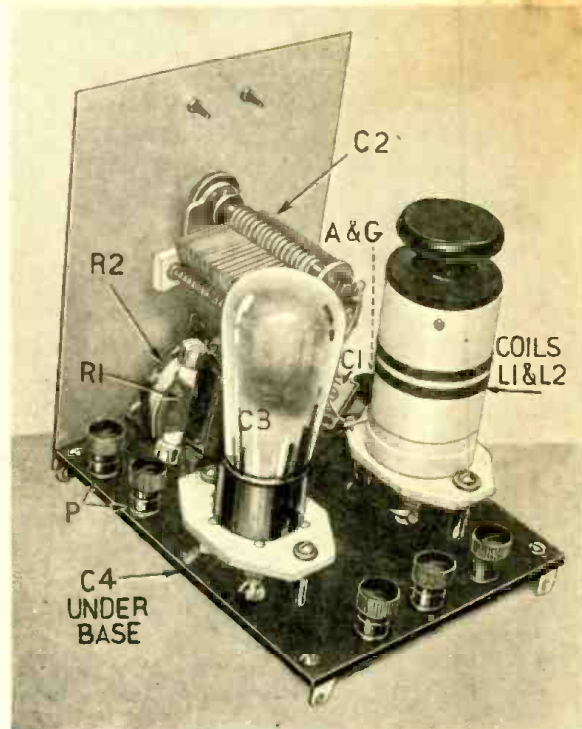

Rear view of the "oscillodyne," with parts labeled to correspond with those in the diagram.

denser and leak, whereupon the cycle repeats itself as shown.

A similar group of curves is shown in Fig. 3 for an initial disturbance having five times the amplitude of that in Fig. 2. The important thing to notice is that the average plate current ("D" Fig. 3C) is less than in the preceding case due to the greater number of "dips" the plate current makes during a given interval of time. Thus, it becomes obvious that a variation in the intensity of the signal applied to the grid results in a corresponding variation in the average plate current. Consequently, a modulated radio frequency signal will produce audible variations in the current flowing through the earphones in the plate circuit.

To sum up, it can be stated that the operation of this circuit depends on the fact that in an oscillatory circuit, prior to the establishment of sustained oscillations, the time required for an impulse to build up to a given value is proportional to the initial value of that impulse. This contrasts with the super-regenerative circuit in which

use is made of the fact that the value to which an impulse will build during a given interval of time is dependent on the initial value of that impulse.

Before leaving the theoretical side of the subject it might be advisable to point out that for proper operation of the circuit it is necessary that the oscillations in the grid circuit entirely die out during the period in which the charge is leaking off the grid. This is to enable the next train of oscillations to build up from the amplitude of the signal present on the grid at that time and not from the amplitude of the preceding train of oscillations which would otherwise be present. Thus it will be found that for satisfactory reception of broadcast frequencies the damping constant of the coil and condenser combination ( $E_{RL}$ ) is not large enough without adding considerable external resistance, which necessitates a corresponding increase in the feedback employed. The feedback cannot be increased indefinitely, however,

(Continued on page 747)

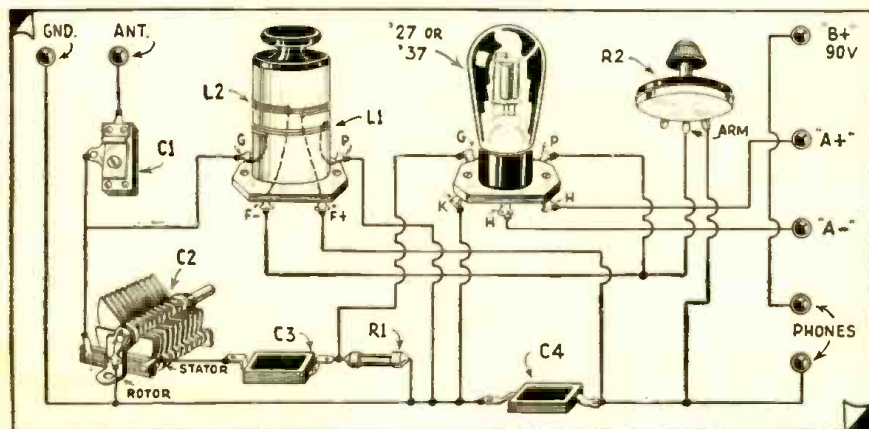

Picture wiring diagram for building the "Oscillodyne"; an "A-B-C" analysis of the set.

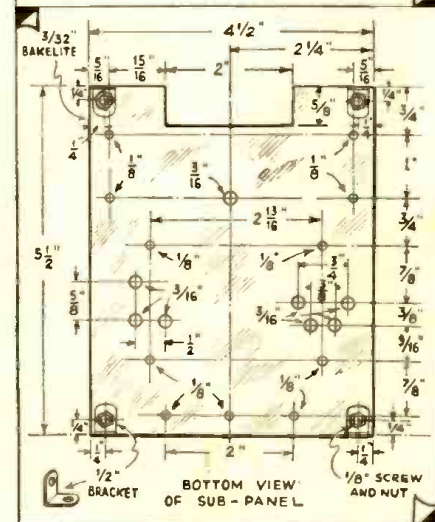
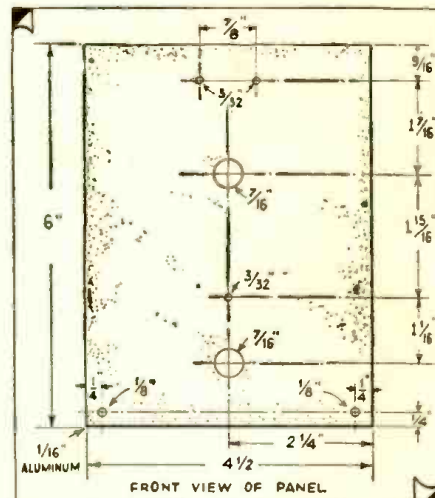

Layout for the "Oscillodyne" receiver panel and subpanel.

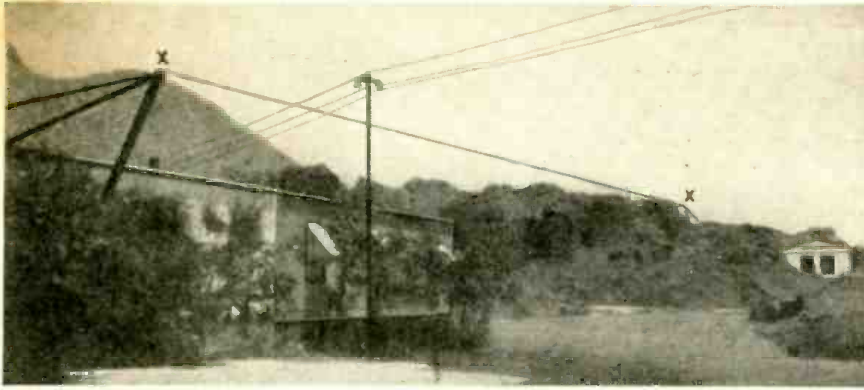

Mr. Baldwin's receiving antenna, a single wire extending between points X—X; average height above ground is 14 ft.

## A South American 7-Tube All-Wave Superhet

By P. P. BALDWIN and C. W. PALMER

\$20.00 January Prize Winner

● This article has been written to describe an unusual type of receiver, designed to operate under extremely unfavorable conditions, over long distances. There is nothing radical or new in it; it is simply the result of experiments carried on over a period of time, to overcome a condition of static that at first appeared impossible to combat.

The writer is in a part of the world that is notorious for poor and noisy reception; due probably to lack of vegetation, lack of rains and the fact that the earth is heavily mineralized with copper. Tocopilla (Chile) is located on a narrow strip of land about one-half mile wide with hills 1,200 feet high and almost vertical to the east and the Pacific ocean on the west.

A number of superheterodyne receivers have been built, ranging from autodynes with 30 kc. intermediate frequency amplifiers, to the present set with a 425 kc. amplifier. It is necessary to have good sets here, for our nearest stations are W2XAD, W2XAF and

W8XX, which are about 3,500 miles away. With this set I get France, Germany, England, Italy, Spain, Indo-China, Japan, Australia and the United States, every day and night, *consistently!* Of course, on some days and nights there is an unusually large amount of static, but we average about 80% of the time when reception is well worth while. All this is on the *loud speaker*, for I threw phones away three years ago! When I have to sit with a pair of phones clamped on my head, I'll give up radio.

### The Chassis and Shielding

The chassis of the set is 20½ inches long by 11¾ inches wide with 2 inch sides. This allows ample space to mount all by-pass condensers and resistors below deck. I used a piece of ¼ inch sheet brass for the chassis as it was the only metal I could get, except iron. What a job I had bending the sides and ends for the walls and then when it was welded the whole thing warped and had to be drawn back into shape by peening

Suppose you lived in the "world's worst" radio location. A place where the static made a barrage of heavy artillery sound like a pop-gun by comparison! What kind of a set would you use?

This is only one of the difficulties that Mr. Baldwin, an engineer in Tocopilla, Chile, had to contend with. The extremely bad static is supposedly caused by the reaction of the cold Humboldt ocean current which runs along the coast, on the dry hot air from the high inland, as well as the lack of vegetation and the character of the land, which incidentally is heavily mineralized with copper.

Mr. Baldwin has been in this country for a number of years and has spent considerable time and money trying to find a receiver that would satisfactorily pick up the outside world, especially the United States. How well he has succeeded is shown in a letter written to C. W. Palmer, in which stations in France, Germany, England, Italy, Spain, Indo-China, Japan, Australia, and eastern United States are listed.

The system used to reduce the extremely bad static condition consists of a combination of extremely sharp tuning, to reduce the noise picked up on other than the carrier frequency; and a high frequency audio cut-off filter. As the nearest stations to Tocopilla are some 3,500 miles away, it is evident that an extremely sensitive set is required to give consistent results. This receiver employs four stages of impedance coupling in the intermediate frequency amplifier, using vario-mu tubes—7 tubes in all. It tunes from 16 to 550 meters with seven sets of coils.

it with a ball peen hammer! Those of you who are more fortunately located than I can go to a sheet metal dealer

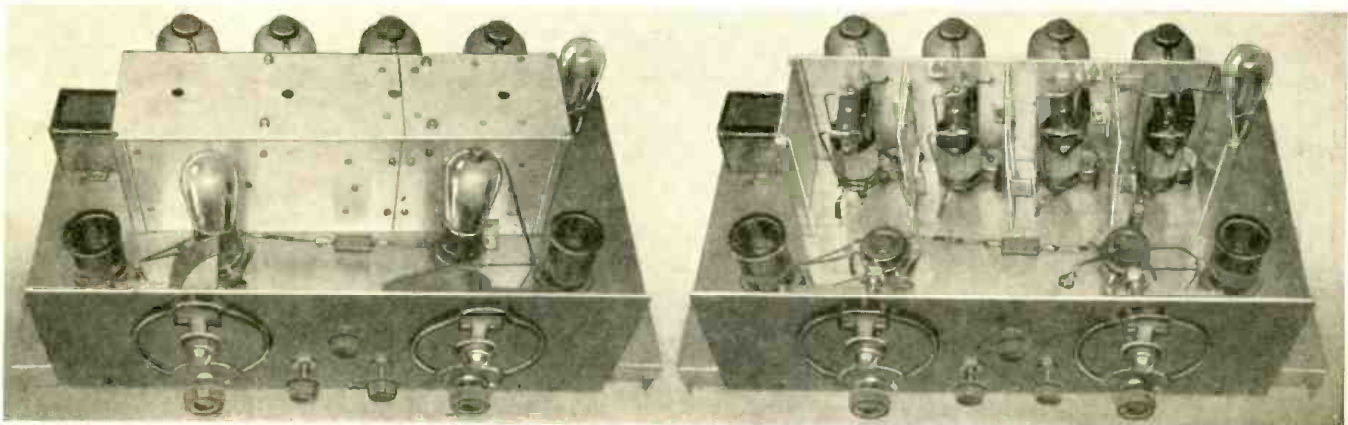

Front view of the 7-tube "superhet," with I.F. coil shields in place.

Another view of the superhet, with I.F. coil shields open.

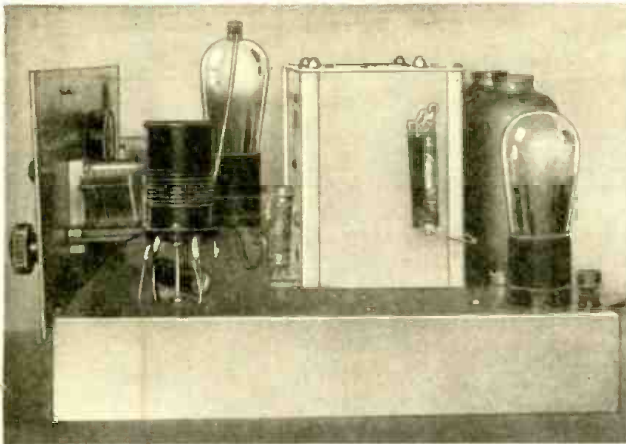

End view of the 7-tube superhet, all "hand built."

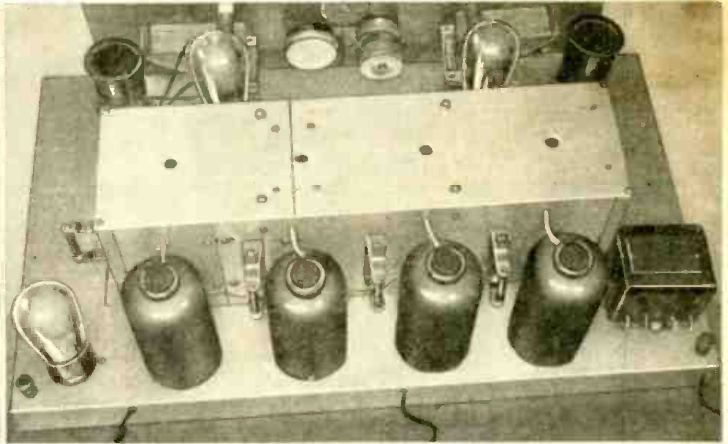

Looking down on the rear of the "all wave" superhet.

and he will make one for you. There are radio stores that make a specialty of making chasses to order out of aluminum and one of them would be ideal. You see, we are not situated here so that we can run around the corner and order or buy what we need. We either have to use what we have or wait three months for delivery of our order.

The shielding for the intermediate frequency transformers consists of one shield with four compartments. It is 14 inches long by 3 1/2 inches wide by 5 inches high, inside dimensions. In this instance also, I had to use what aluminum I had, as you can see from the photographs. Separate shields, either round or square 3 1/2 inches in diameter by 5 inches high, would be much better.

The I.F. shield assembly is 5 3/4 inches from the front of the chassis, which allows space for mounting the modulator (first detector) and oscillator tubes and coils, as well as the two tuning condensers. To the rear of the shield there is space for the five tube sockets to be mounted, with their shields.

**The I.F. Coils**

The intermediate frequency coils, which are of the impedance coupled type and so have only a single winding, are made as shown in diagram. Pilot ribbed short-wave coil forms are employed. Take off the handle as we do not need it any more and drill a 7/32 inch hole in the center of the bottom for a 2 inch 6-32 bolt. Put the bolt

through the hole with the head on the inside and tighten a nut on the outside. This is used to mount the coil on the chassis. Remove the prongs from the four coil forms and then fasten two soldering lugs on three of them, using small screws. On the fourth, fasten four lugs. The extra lugs on this form are for the tickler coil of the second detector.

Start winding 1/2 inch from the bottom of the form and begin each coil at the same lug (so as to prevent confusion later) and wind on 132 turns of No. 32 single silk enamelled wire. Use care in winding these coils so that you do not stretch the wire and about every five turns gently press the turns together with your finger nail. Use the same pressure each time so that when the four coils are wound, they will all have the same length of winding.

Drill small holes through the forms at the beginning and end of the windings and pass the wire down through the inside to the correct lugs. On the coil with the four lugs wind 132 turns the same as the others and then wind another coil of 12 turns 1/8th inch below. Wind this coil in the same direction as the other and use the same size of wire. This is the tickler for the second detector.

The shielded plate lead from the second detector goes to the bottom end of this tickler winding and the upper end is the unshielded lead to the radio frequency choke Ch-5. The shielded

plate lead of the preceding tube goes to the soldering lug to which the top of the 132 turn winding is fastened. The bottom end of this winding connects to the shielded 50 mh. R.F. choke coil which is located in the shield compartment.

The semi-variable condensers that tune the intermediate frequency transformers (C3, C4, C5, C6) are XL Variocdsensers type, G5, which have a capacity range of .0001 to .0005 mf. They are mounted across the top end of the coil forms with small angles and the .0003 (C9, C10, C11) and .01 (C12) blocking condensers have long soldering lugs soldered on one end and bent at right angles so they fit over the terminals of the tuning condensers (C3, C4, C5, C6). Be sure that they are connected to the terminal to which the plate lead from the preceding tube is wired.

Assemble the I.F. coils completely before fastening them to the chassis—that is, they will have their winding, tuning condenser bolted on, blocking condenser in place with the two leads from the lugs on the coil (to which the 132 turn winding is secured) running up on the outside of the form to the two terminals on the tuning Variocdsenser.

Make certain that all the coils are made exactly the same—I mean do not have the plate lead going to the bottom of one coil and the top of another. By having all the same you can never be-

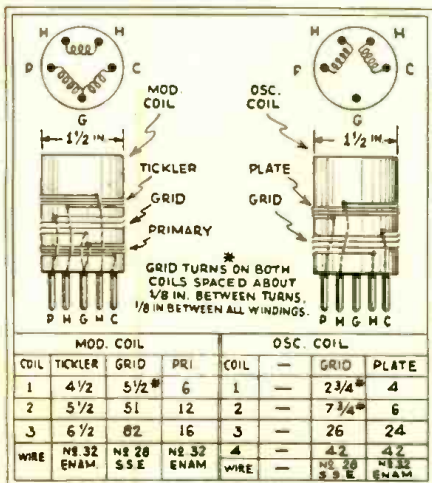

Coil data for "all wave" super.

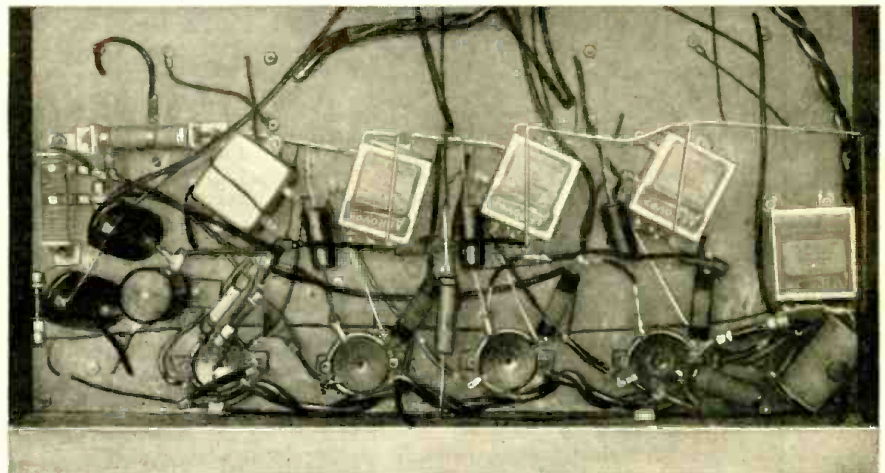

Bottom view of the Baldwin-Palmer "All Wave" Superheterodyne Receiver.

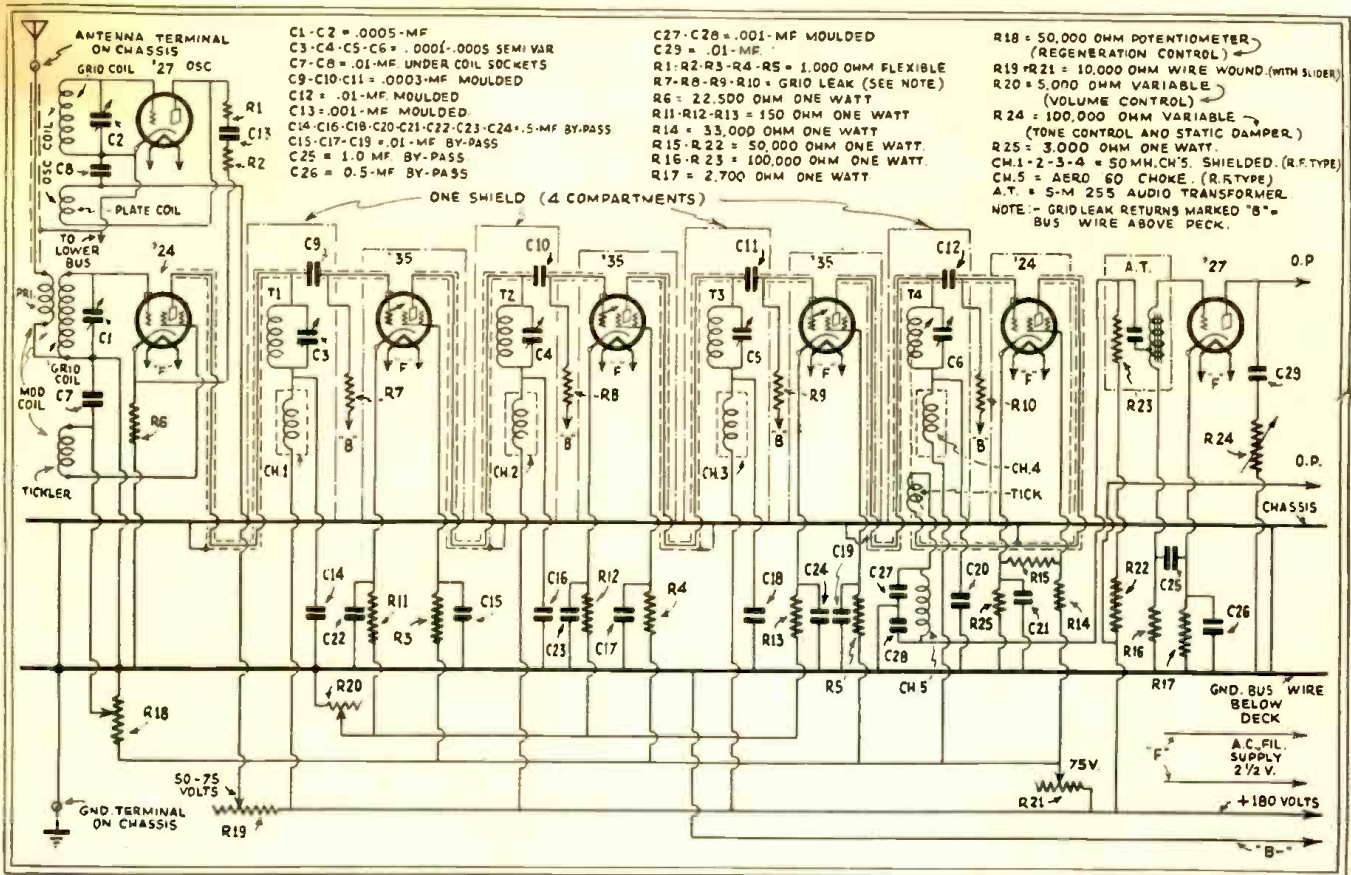

Schematic wiring diagram, showing all the parts and their relation to one another in the South American "All-Wave" receiver described here by Messrs. Baldwin and Palmer.

come confused. The plate lead connects to the lug to which the top of the winding is fastened.

When all the I.F. coils are finished and the holes are drilled through the chassis for the plate wires and the "B plus" leads to the R.F. chokes and the chokes are bolted in the corner of the compartments; the holes can be drilled in the exact center of the compartments for mounting the coil assemblies. Put a nut on the mounting screw and run it up so that another nut can be put on underneath the chassis. The 132 turn coil should be about 1 1/2 inches long and the shield is 5 inches high. The coil should be placed as near the exact center of the compartment as possible, so if the bottom is placed 1 1/4 inches from the chassis, the top will be 1 1/2 inches from the top. When you have the coil in place, tighten up on the nuts on top and bottom of the chassis. Repeat the procedure for each coil.

#### Assembly and Wiring

This completes the assembly of the intermediate coupling coils. The by-pass condensers C14, C16, C18 and C20 for the plate supply are mounted below deck, directly under the I.F. coils, so that the radio frequency currents are by-passed as soon as they come below. The grid leak mountings R7, R8, R9, and R10 are bolted vertically on the outside of the I.F. shield (between the tube shields) with the top end level with the coupling condensers C9, C10, C11 and C12, so that the wires to these condensers are only about 1 1/2 inches long. The shielded leads to the control grids of the following tubes are also soldered to the grid leak mountings, thus making the grid circuits ex-

tremely short. After the grid leak mountings have been secured and wired, solder the leads to the I.F. coil assemblies and pass the wires through their respective holes. Then put on the shield covers and close them up to avoid injury to the windings. First, however, drill four 3/8 inch holes in the shield cover over the adjusting screws of the variometers to permit tuning of the I.F. circuits. Use only a non-metal screw driver for this purpose, to avoid making a short-circuit.

Below deck you have mounted the four by-pass condensers C14, C16, C18 and C20 in the plate leads and now on top of them mount condensers C22, C23 and C24, which are the by-pass condensers for the cathode leads and C21 which is in the screen-grid lead. Now run a piece of heavy copper wire (about No. 14) along this double row of by-pass condensers and bend it so that all the ground sides of the condensers can be soldered to it.

You may wonder why this special ground bus wire—well, I don't believe in grounding all ground leads to the chassis and thus allow the stray R.F. currents to go chasing around at random, so I use a copper wire to which all grounded wires are soldered and lead the R.F. currents away. All by-pass condensers in plate, screen-grid and cathode circuits are grounded to this lower bus wire and there is another wire of the same size that is bent to be soldered to the grounded sides of the four grid leaks R7, R8, R9, and R10 mounted on the I.F. coil shield can. The upper and lower bus wires are connected together by a wire, and neither one touches the chassis, shields or tin covers of by-pass condensers, although

there is a lead from the lower bus bolted to the chassis by the nut holding the ground binding post in place. The "B minus" lead is soldered to about the middle of the lower bus. This may not amount to much, but at least it produces a more workmanlike job. There is no difficulty to find a place to fasten a ground lead as the bus wire runs the length of the chassis. The two wire-wound Electrad resistors, R19 and R21, are mounted with two angles with a bolt running through the center of the resistors.

#### The Oscillator and Modulator

The oscillator and modulator tuning condensers C1 and C2 are .0005 mf. and of good make. Do not try to use any inferior condensers for we are going against all rules and regulations by employing .0005 mf. tuning condensers for short waves, but we are doing it and will keep on doing it by using good condensers where the loss is not too high and the minimum capacity is low. In this set I used Hammarlund condensers, but in a previous one I used Kara's condensers (no longer made) and they have both been all that could be desired. Of course, on the short waves the tuning is extremely sharp, but personally I do not mind this. I use the parts I have available, for as I pointed out before, I cannot run around the corner and get what I want, nor can I order by mail and get delivery in three or four days.

If you have a pair of good .00035 mf. condensers they can be used, but about six more turns will have to be added to the grid coils of both the oscillator and modulator for the 200 to 550 meter band.

(Continued on page 749)

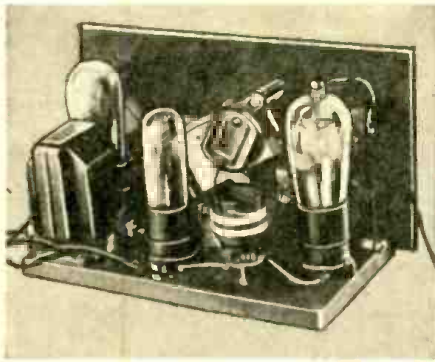

Rear view of the dolled up "Go-Getter," with untuned R.F. stage and pentode output tube added. All tubes are of the 2-volt battery type.

# DOLLING UP the "GO-GETTER"

By HARRY D. HOOTON

In the last number of SHORT WAVE CRAFT, Mr. Hooton described his 2-Tube "Go-Getter" receiver for the beginner. In the present article, Mr. Hooton explains how to "doll up" the Go-Getter with an untuned radio frequency stage and also a pentode output stage. This combination makes an excellent low-cost receiver for the fan who "builds his own."

● WHILE the "Go-Getter" receiver in the original regenerative detector and one-stage audio circuit described in the March issue, is an excellent receiver for the average short-wave "beginner," the more advanced experimenter will require a better and more up to date set. Most of these short-wave listeners desire a receiver having enough power for loud speaker operation on both local and distant stations; the receiver must have at least one stage of radio-frequency amplification to boost the weak signal and to prevent radiation of the regenerative oscillations. It is the purpose of this article to describe, in detail, a method of adding an *untuned radio-frequency stage* and a *pentode output stage* to the short-wave set described in a previous article. This combination makes an excellent "low-cost" receiver for the fellow who "builds his own."

A comparison of Fig. 2 with the original circuit (Fig. 3) shows that only a few changes in the two tube set itself are necessary. Isolate the antenna series condenser from the detector circuit by removing the wire which connects it to the fixed plate of the tuning condenser. Do not remove the condenser from the panel, as it is to be incorporated in the new circuit. Cut the wire leading from the lower or filament end of the coil to the rotor and end plates of the Cardwell and insert a Sangamo .006 mf. fixed condenser (C3) in series with it. This blocking condenser is mounted on the metal end

plate of the tuning condenser by means of a machine screw (see Fig. 1). Care must be taken that the fixed condenser is not short-circuited by the metal plate of the Cardwell. The 1 mf. by-pass condenser (C5) is turned around parallel with the panel, directly under the tuning condenser, and is held in place by means of two brass wood-screws. Remove the UX socket from the audio end of the set and substitute for it a UY or 5 prong type, which is required by the pentode tube.

The next step is to mount the radio-frequency tube socket, the fixed resistor and the by-pass condensers. The socket is mounted first. Place it, as shown in Fig. 1, at the extreme right, directly in front of the Pilot Resistograd (looking at the rear of the set) and about two inches from the coil socket. The socket should be mounted in the manner which will allow the shortest radio-frequency leads between it and the other parts of the circuit. A short flexible wire terminating in a clip connects the fixed plates of the antenna-series condenser with the grid cap on the screen-grid tube.

The 10,000 ohm resistor (R4) is mounted on the base-board between the tube socket and the regeneration control. The by-pass condenser (C6) is mounted on the base-board between the socket and the 1 mf. by-pass condenser (C5). These parts are wired in the circuit as shown in Fig. 2.

This receiver was designed for operation with the new low-drain battery type tubes, but it is possible to operate with A.C. tubes, provided the proper

filament, plate and biasing voltages are applied. Not all "B" eliminators will work properly with this set. We have obtained the best results with a rebuilt power supply taken from a Philco receiver. Unless the experimenter has had some experience with electrically operated sets it is best to stick to batteries for power.

It is absolutely necessary that an output (1 to 1 ratio) transformer be included in the plate circuit of the pentode tube, as the speaker windings are liable to burn out, due to the heavy current, if connected in the usual manner. This transformer is not included in Figs. 1 and 2 as it is part of the speaker which we use on this set. It is a good idea to examine the speaker in order to determine if the output transformer is built in with the unit. If it is not, a separate transformer may be mounted either inside the receiver itself or on the speaker.

Best results will be obtained when a long antenna (50 to 150 feet including the lead in wire) is used. The midget condenser may be "shorted out" when using a short antenna, although the selectivity is greatly improved by its use. The improved model is tuned in exactly the same manner as the two-tube set.

### Key to Figs. 2 and 3. "Special"

C1—Cardwell tuning condenser; 2 plate 201E type or any 50 mmf. variable condenser will do.

C2—Fixed condenser .0001 mf.

(Continued on page 758)

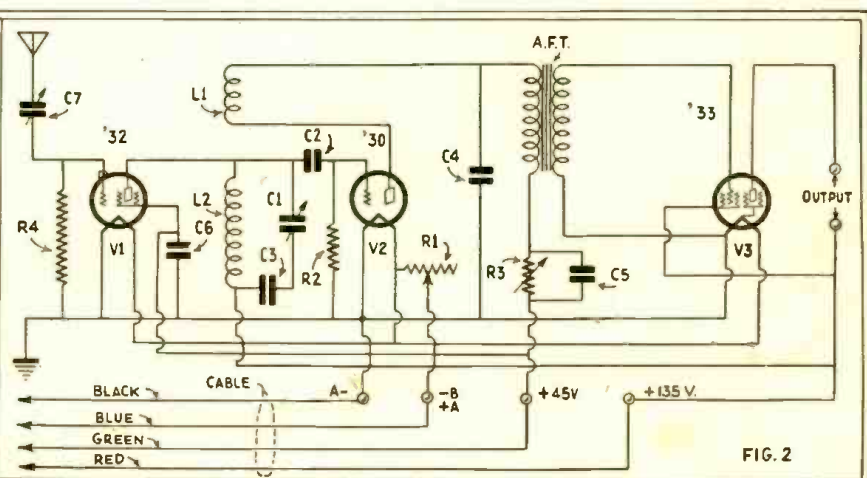
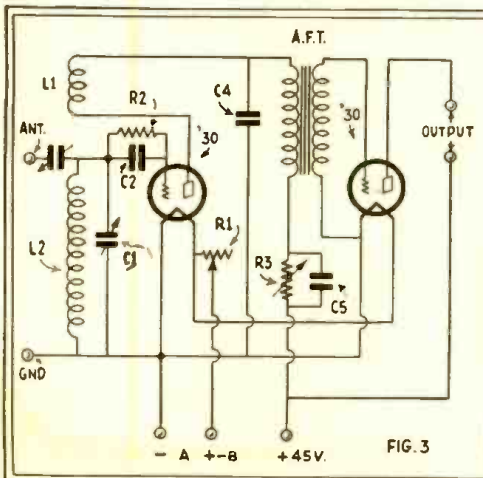

Diagram at left shows the original 2-tube "Go-Getter" hook-up, as given in the March number. Diagram at the right shows the improved modified "Go-Getter" hook-up, incorporating an untuned R.F. stage and a pentode output stage.

# A New National

By JAMES MILLEN\*



Fig. 3. Little need be said concerning this top view of the new receiver. Its compactness, symmetry of design and complete expressibility are immediately apparent.

control and comparatively reasonable in price. There has been a great deal of discussion regarding the advisability of making a combination broadcast receiver which will also perform satisfactorily on short-wave. Several extremely satisfactory receivers of this general type have been marketed and are performing a very valuable service in familiarizing the broadcast listener with the extremely interesting programs which are now available on short-waves. Then, too, several very satisfactory short-wave receivers for amateur communication purposes have been introduced and have been giving a very satisfactory account of themselves.

The combination broadcast and short-

above, are also very expensive and the majority of amateur radio telephone and telegraph communications enthusiasts ("hams," as they are called among themselves) demand characteristics in a communications receiver which are not generally found in the combination type.

Before embarking upon a description of the particular characteristics of the new receiver to be described here, it may be well to clear up one point which has been causing a considerable amount of discussion among short-wave enthusiasts and engineers as well. The question has to do with the desirability of covering a great band of wavelength without the necessity of changing coils. Experience has led us to the conclusion that the most satisfactory type of receiver for short-wave use is one which employs changeable coils. We have made several receivers, in which the change from one frequency band to another has been accomplished by a switching arrangement with coils mounted directly in the receiver itself. I do not believe that any receiver can be made to function as well on all of the wavelength bands, unless it is provided with *changeable coils*. Other radio engineers who have argued against this policy have recently come around to this way of thinking and several companies, formerly engaged exclusively in the making and selling of high-grade combination receivers, are now introducing special receivers designed for short-wave operation exclusively.

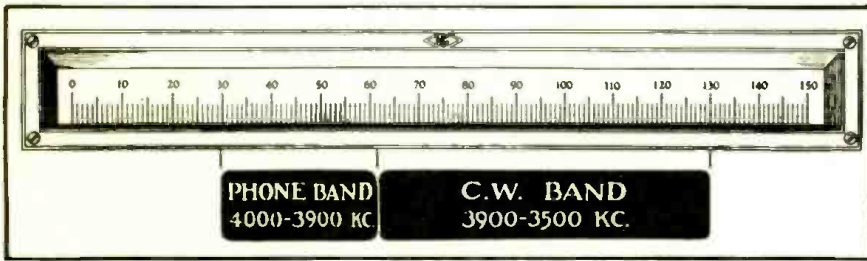

Fig. 4. One of the remarkable characteristics of the new receiver is graphically portrayed in the accompanying illustration. Here we have indicated the performance characteristics of the receiver when the "band-spread" coils for the 80 meter band are employed. It will be observed that the spread from 4,000 to 3,500 kc occupies 100 divisions on the dial, leaving an overlap of approximately 25 divisions at either end. Due to the special characteristics of the plates used on the condensers, the amateur phone band of 100 kilocycles occupies approximately half the space occupied by the 400 kilocycles in the adjacent C.W. channel.

● Nearly all of us recognize that there is an increasing demand for short-wave receivers which are highly selective and very sensitive, simple to con-

wave receivers, if they are of the high quality to which we have referred

\*General Manager, National Company.

### Purpose of the New Receiver

In consideration of all these factors and in view of the extremely satisfactory performance which the AGS receiver is delivering in all fields of com-

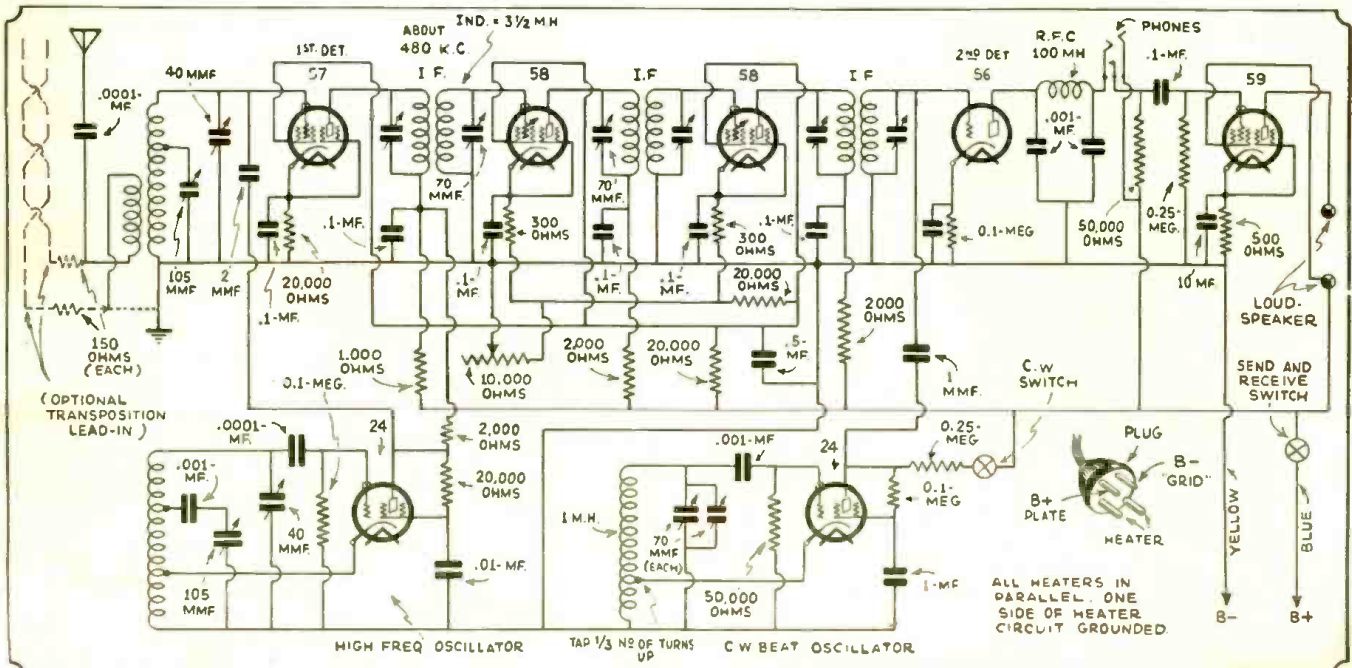

Fig. 1. The complete circuit diagram of the new National FB-7 Short-Wave Superheterodyne Receiver. Seven of the latest tubes are employed and the receiver is ideal for use in connection with many services as a study of the circuit will disclose. All of the heaters are connected in parallel. It will be noticed that one side of the heater circuit is grounded to prevent radiation from the beat oscillator. Other systems, commonly employed, were found inadequate.



# Super-het, the "FB-7"

munication on short-waves, the impression grew that many of the design features incorporated in that receiver could be applied to a simpler set which would be ideal for use by the *short-wave broadcast listener*, who is particularly interested in the reception of "foreign" programs, as well as the amateur operator who, for his communication purposes, requires a far better short-wave receiver than the average and who at the same time cannot afford to avail himself of the commercial type.

## General Characteristics

This new receiver carries the designation "FB-7". This designation is particularly applicable to a receiver especially suited to the needs of the amateur communication enthusiasts. FB stands for *phone band* and in the vernacular of the "ham" it also means *fine business*, which is an expression commonly employed to indicate satisfactory results.

The FB-7 is essentially a short-wave superheterodyne of the most advanced type, incorporating many of the features only to be found in the most expensive and elaborate receivers of the strictly commercial type. As may be seen from the accompanying illustration, the entire receiver is comparatively compact, while all of the component parts are completely accessible. The tuning scale is of the full vision type and is thoroughly illuminated. Tuning is accomplished by a single knob and there are no additional adjustments of any kind, other than the volume control. The tuning range of the receiver is from 15 to 200 meters or 20,000 kilocycles to 1,500 kilocycles. Five different sets of coils, with suitable overlap, are used to cover this range; they are of the regular National commercial type and plug directly into the front panel of the receiver. Provision is made for both telephone and loud speaker operation and the receiver may be operated from the regular National power supply unit or from batteries. "Hams" who desire to use this type of receiver for communication purposes sometimes find it desirable to operate from a small filament transformer and "B" batteries. This enables them to duplicate the performance of the receiver operated from the regular power supply, at slightly reduced cost.

To be more specific:

Determining upon the circuit which would most nearly meet all of the conditions required for the communication services, for which this type of receiver was designed, was the subject of a great deal of study. Another important subject was the determination of the particular types of tubes which would best function in a receiver from which so much was to be demanded. From antenna to loud speaker, we believe that the FB-7 is the satisfactory solution to a great many receiver problems. The following tubes have been selected because they seem to suit the requirements admirably. The first detector is the type 57; the high frequency oscillator and the beat oscillator are of the 24 type; the two intermediate frequency amplifier tubes are 58's; the second detector is the 56 and the output tube is the type 59 pentode. A complete diagram of the circuit employed

in this receiver appears in Fig. 1, but many of the important features of the receiver are not immediately obvious from a study of the diagram. A study of the various portions of the circuit and the reasons for their selection will give a very much more definite idea of the performance which may be expected for particular types of service.

Take the antenna, for instance. For suitable tuning over a wide band of frequencies, it is desirable to have an antenna circuit in which antenna tuning effects are reduced to a minimum. A large size primary coil is always desirable but in most cases its use has always been accompanied by high inductance and capacity which, in turn, have made a tuning free antenna system almost impossible. My experience in the design of short-wave receivers and the success obtained in connection with National standard plug-in coils for example, resulted in following a somewhat similar procedure in connection with the coils designed for the FB-7. The antenna primary is *interwound* with the secondary, in a manner which brings about a considerable loading effect which is constant and also permits utilizing the advantage of close coupling, without any noticeable antenna tuning effects.

Furthermore, the particular type of antenna circuit employed permits taking full advantage of the desirable features which a modern tuned doublet and suitable transposed transmission lines bring about. The use of the tuned doublet is becoming generally recognized as standard practice, where the best type of receiving engineering is involved. Interference, of the *man-made* variety, is reduced to a considerable degree by the elimination of the



Fig. 2. Front view of the new FB-7 receiver. The full vision scale is marked off in 150 divisions. The tuning calibration curve for each one of the five sets of coils is mounted on the panel. Directly below the tuning control there is the calibrated volume control, of the type which has proven so popular in measuring signal intensity. The coils plug in from the front. Phone jack is located at the lower left-hand corner of the front panel; switch in lower right-hand corner throws the beat frequency oscillator in and out of circuit.

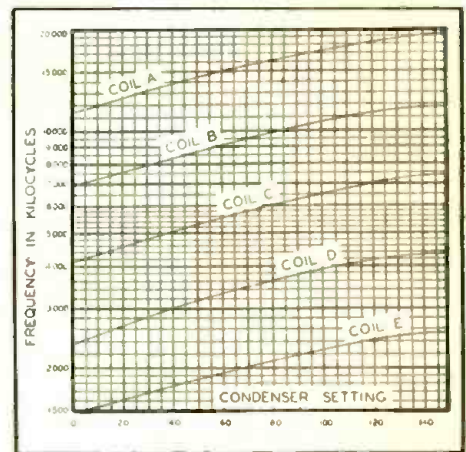

Fig. 5. Tuning Curves for FB-7, with "general coverage" coils.

ordinary ground connection in the antenna circuit. It is possible to take full  
(Continued on page 761)

Short-wave "Fans," and "Ham" operators as well, have been gazing anxiously at the radio horizon, wondering no doubt when they would be able to purchase a laboratory-tested short-wave superheterodyne, at a price which the average "depression" pocketbook could stand. It has remained for James Millen and his staff of engineers to at last produce a smooth-working, 1-dial control superhet, which in the same breath provides the average SW "fan" with DX reception from European and other distant points and—secondly—it provides the licensed operator or "Ham" with a receiver on which the amateur bands can be spread out. With two sets of plug-in coils, one designed for "general coverage" and one set for "band spreading," either or both requirements are fully met. The new FB-7 employs seven of the latest style tubes and has a beat frequency oscillator, so as to pick up CW signals. A specially filtered power-pack has been designed for use with the FB-7.

# A Good 250 Volt POWER SUPPLY for Less Than \$5.00

By **ALBERT W. FRIEND, B.S., E.E., W8DSJ**

A plate supply unit, well-filtered and furnishing no less than 250 volts D. C. is in great demand for operating the modern short-wave receivers fitted with the new type tubes. Mr. Friend provides us with the constructional data on a power-supply unit of this type. We are sure that our readers will find it a very valuable article; the cost of building the unit is nominal.

Photos at left show external and internal appearance of 250 volt power-supply unit here described by Mr. Friend.

noticed that the plates of the 80 type tube are by-passed with .002 mf. condensers. This procedure is to eliminate any possible tunable hums from the short wave receiver. These condensers may be omitted if no trouble of this type is experienced.

If desired, an A. C. line switch may be inserted in any blank space on the chassis; or the power supply may be plugged into a receptacle on the receiver, and a switch on the receiver used to control the power.

### Assembly

In the assembly process, the following order will prove desirable: end panel, power transformer, choke assembly, wafer socket, condensers, and voltage divider. The condensers can easily be secured between one flange and the top. They should be bound together with friction tape. The extra space between them and the flange

(Continued on page 746)

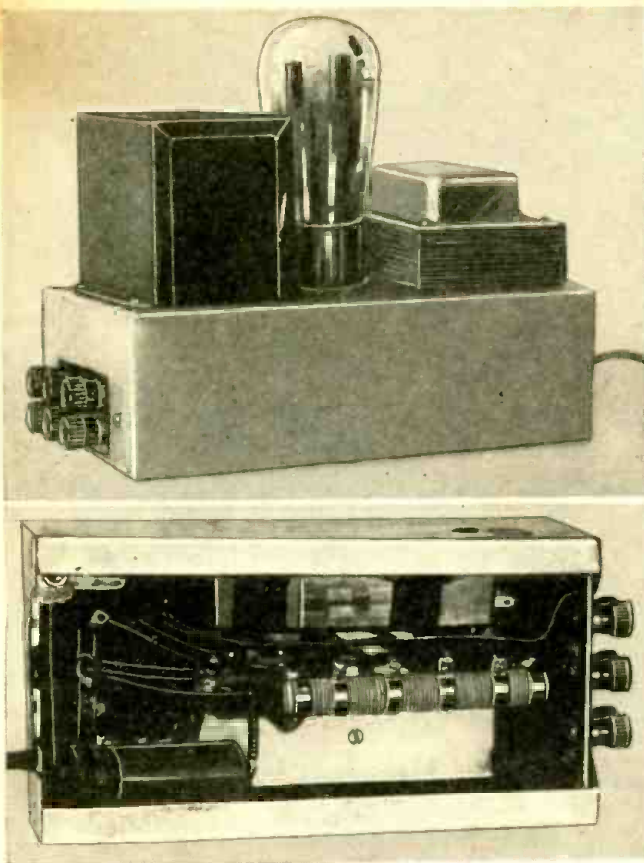

● EVERY short wave experimenter needs a good cheap power supply of small size. I have designed one which can be easily constructed for less than five dollars. It will give 250 volts of pure D.C. at a current drain of 50 milliamperes (more current at a lower voltage) as well as 2.5 volts A.C. at 5.0 amperes. The overall dimensions are only 8½ x 5¼ x 5¼ inches (without the tube).

The unit is very rugged, and the parts used may be easily obtained.

### The Chassis

The first consideration is the chassis. It was constructed of No. 20 gauge galvanized sheet iron, which can be purchased at any tin shop. I bought mine already folded as shown in Fig. 2 for only thirty cents. All that remained to be done was to drill the holes and to cut slots along each fold from each end for a distance of one inch; bend and hammer in the end folds, and solder as indicated (Fig. 3).

The folding operation is best accomplished by placing a piece of 2" x 4" block inside of the chassis (with a squared edge at the folding point) and, after clamping the block and chassis in a vise, hammering the top deck ends down first. After relocating the block, hammer up the ends of the two flanges, and then the ends of the two sides. Solder the points indicated in Fig. 3 with acid core solder and wash off the excess flux to prevent corrosion.

The large holes in the top should be marked with a sharp tool and cut out with a chisel. The edges can be filed smooth to the marked lines. Most experimenters do not have means for drilling the larger round holes. By using curved or round files, a nearly perfect and very neat job can be done without large drills or special cutters.

The bakelite or fiber end panel of

Fig. 4 can be cut from scrap found in almost any ham "junk box."

The binding posts will be found on some old battery set or amplifier. If desired they may be dispensed with and phone tip jacks or a six or seven prong socket may be used for making connections. The latter method will serve very well if all equipment is provided with cable connections. When using binding posts it is convenient to use spade tips on all connecting leads.

### Voltage Divider and Choke

The voltage divider used is variable, by means of sliding bands, and allows any desired voltage combination to be obtained.

The Crosley double 30 henry choke is very compact, of ample rating, and neat in appearance.

Cardboard type (Trutest) dry electrolytic condensers are self healing, compact, of high rating, and very cheap.

The transformer used is a Trutest midget type which gives a high voltage and plenty of current for any ordinary short wave set or experimental layout.

It will be

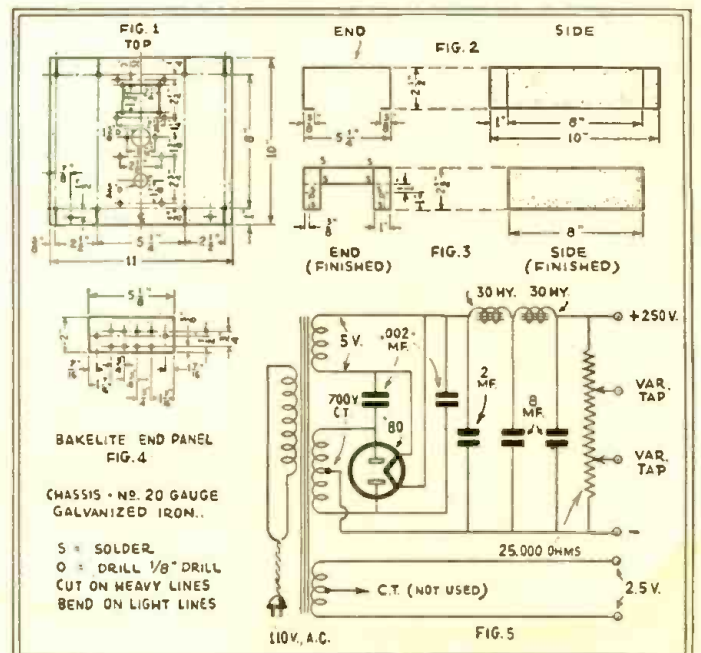

Wiring diagram and constructional details of chassis of 250 volt power-supply unit.

# The LINCOLN R-9:

## A New 9 to 200 Meter S-W Super-het Using 11 Tubes

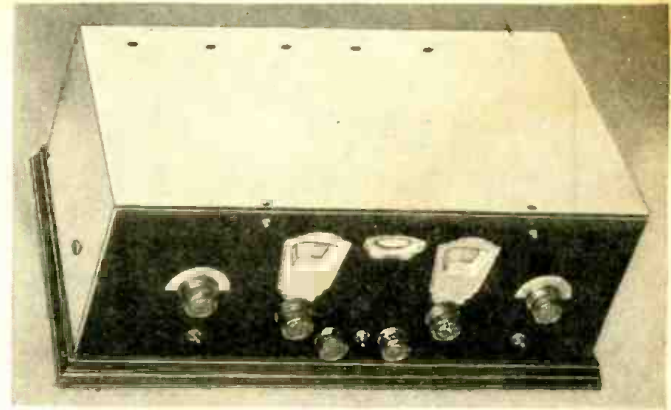

Photo above—business-like appearance of the newest Lincoln off-spring, the R-9 short-wave super-het, with 11 tubes.

Interesting new 11-tube short-wave super-het has range of 9 to 200 meters; 8 tuned circuits; A.V.C.; 45 push-pull output; Visual tuning meter and C.W. beat oscillator.

OWING to the increased demand in both commercial and broadcast listeners fields, many months of development work have been put on the new Lincoln R-9 receiver, designed to register wavelengths from 9 to 200 meters. While the field has been well covered with commercial types of short-wave receivers and combinations of short-wave and broadcast, yet the strictly short-wave receiver design has not had the attention that a few of the receivers ranging from 15-550 meters have had.

Leaving out the aspect of the commercial requirements of this type of receiver, the ever increasing number of interesting short-wave phone stations and the ever increasing power of these stations are opening up a new field of intense interest and enjoyment to the broadcast listener.

The average installation of the all-wave receiver is made in the living room or library of the home and in a

great many cases Mr. Radio Fan is confronted with a dozen arguments as to whether the household listens to an airplane transmission, amateur phone, trans-oceanic messages, foreign broadcast, or to some good "chain" station in the 200-550 meter broadcast band.

In view of the fact that the majority of homes have a good broadcast receiver, many ardent fans have requested a strictly short-wave receiver, which may be hidden away in the den behind locked doors, so that Mr. Fan can have full enjoyment of the one hundred and one interesting transmissions found in the wide band of high frequencies ranging over eighteen to nineteen thousand kilocycles, while friend wife, perchance, listens to her chosen program in the broadcast band in peace.

With this thought in mind, and due to the large demand for this type of receiver, the Lincoln R-9 has been developed to a high degree of perfection, utilizing the full knowledge and wide experience gained in the development of the high-powered DeLuxe receivers. Every desirable feature of the regular DeLuxe receiver is applied in the new R-9 with the exception that the "broadcast" coverage (200 to 550 meters) has been eliminated, and every feature

desirable for both short wave phone and C.W. reception has been added.

### Silver-Contact Band Selector-Switch

The general plan of the R-9 employs the proved design of the DeLuxe SW-33, utilizing the silver-contact selector-switch, which independently selects the desired inductances for group frequency range. The grouping of the frequencies is as follows: Starting from the lower wave end—

1st position	8.8 meters to	16.8
2nd position	14.6 meters to	27.7
3rd position	27.4 meters to	51.6
4th position	48.2 meters to	99.
5th position	86.2 meters to	216.

The circuit uses an intermediate frequency amplifier of three powerful stages, with tuned first detector stage. The coils are of Litz wire; eight tuned circuits are used. The last I.F. stage is of balanced-grid push-pull construction, feeding into the Wunderlich tube (2nd detector), the output of which feeds into the transformer coupled 56 first audio stage and through large transformer coupling into two 45 push-pull output tubes. Tubes used are 4-58; 3-56; 1-Wunderlich; 2-45; and 1-80.

Due to the remarkable action of the Wunderlich tube, perfect automatic  
(Continued on page 758)

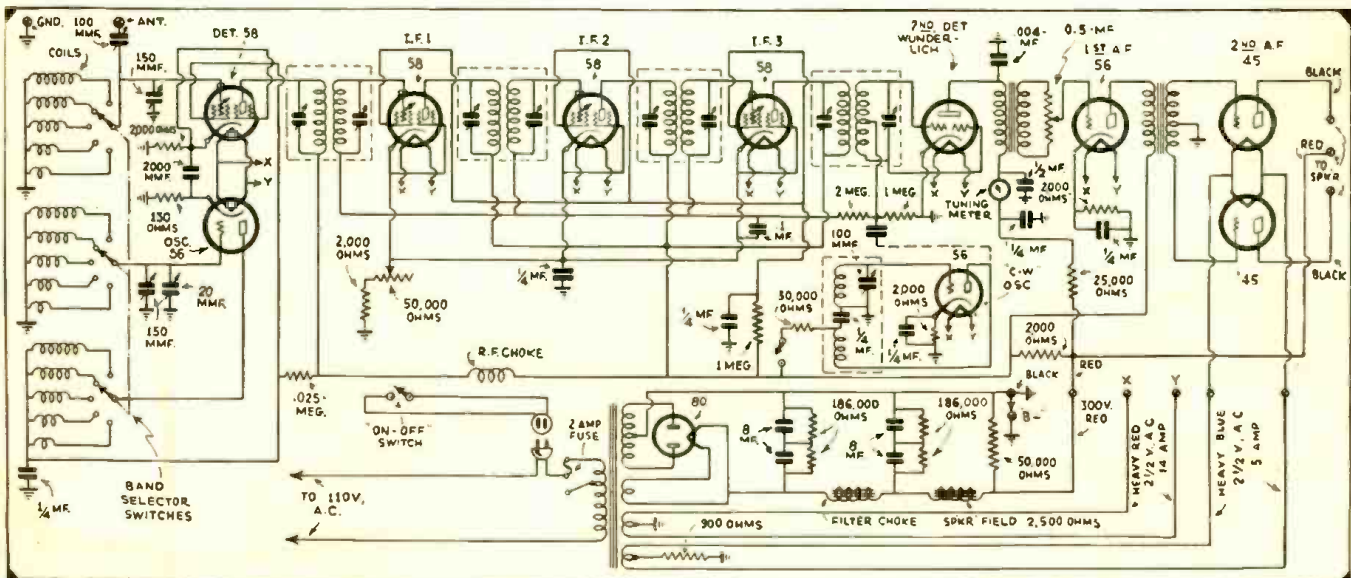

Diagram of the new Lincoln R-9 Superheterodyne, especially designed for reception in the short-wave spectrum from 9 to 200 meters. Switches select the proper coils for each band.

# The Short-Wave Beginner

No. 10 of a Series

By C. W. PALMER

## The Symbols

● **Aerial:** This symbol represents the ordinary type of outdoor aerial used with most receivers, although it may also be employed to represent indoor or underground aeriels and those with special characteristics such as noise reduction, etc. The loop or coil aerial is shown directly below the extended type. This symbol is used to represent both the flat spiral and the square (box) types ordinarily used.

**Ground:** The standard symbol for a ground connection or "earth," as it is sometimes called, is shown below the aeriels. This symbol indicates connections made to the grounded chassis of a receiver as well as the actual connection to the water pipe or other form of ground. The *counterpoise* symbol appears next. A *counterpoise* is a group of wires suspended below the aerial a few feet above the ground and insulated from it. It is commonly used for transmitters and in a few cases for receivers, especially where the soil is dry or sandy so that it is difficult to obtain a good "ground."

**Condensers:** Several symbols for condensers of different types are shown. The first represents *fixed* capacities and pictures of both the mica and the paper insulated varieties are given. The symbol for both is the same. Next is the *variable* air-insulated condenser of the ordinary rotary type. This is usually represented by two parallel lines with an arrow running diagonally through, but in some cases, the moving or rotating plates are indicated by a curved arrow instead of the flat parallel lines. Below the variable condenser is the "ganged" condenser, which is simply a number of variable air condensers connected on a single shaft for tuning more than one circuit with a single dial. The last condenser symbol is the "condenser block" or group of capacities in a single metal case, which are used primarily for the filter circuits of A.C. power units. The number of individual capacities is shown by the number of small sections in the upper line, and by the number of leads extending from the condenser block.

**Inductors:** The standard symbol for coils of any type is shown first. In this form, the coil is understood to have an air core (no iron or other metal) and may be either a radio frequency tuning coil or an R.F. choke, as the picture shows. When two air-core coils are placed close together, they are coupled and the unit becomes an R.F. coupling coil or transformer, commonly used for coupling the aerial to the first tube in a set or one R.F. tube to another.

The next in order is the continuously variable inductance or, as it is generally termed, the "variometer." This consists of two R.F. coils coupled closely together and arranged so that their inductances may either aid each other or work in opposition. Below the variometer is a tapped coil. Sometimes it is desirable to change the size of a coil. This is accomplished by

## Schematic Symbols — Radio's Shorthand: A Simple Explanation of What the Symbols Are and How They Are Used in Circuit Diagrams

bringing leads out from the winding at the desired points; the coil is then said to be "tapped."

Following the tapped coil are several symbols indicating coils with *iron cores*. The presence of the iron is indicated by the three parallel lines placed either through the spiral (the coil) or adjacent to it. The first is a single iron core coil—commonly known as an A.F. (audio or low frequency) choke coil. We run across this coil in A.F. amplifiers and power units. When two coils are coupled together with an iron core, we have a transformer—either an A.F. coupling transformer, or one used for power supply purposes. A special type of A.F. transformer is shown at the top of the second column; it is the push-pull transformer with a tap at the center of one of the windings, so that two tubes may be connected opposite each other.

**Resistors:** A number of special types of resistors are pictured next. The first is an ordinary fixed resistor of any value; below this is a variable resistor with an arm to make contact at any point on the resistance wire. A special type of variable resistor is the potentiometer or "voltage divider," shown next.

**Circuit Connections:** Wires that cross but are not connected are shown schematically by making a semi-circular bend in one. Wires that cross and are connected together are shown with a black circular intersection—a distinct round dot.

**Crystals:** Two types of crystals are used in radio equipment. First is the *crystal rectifier* or *detector*, which is still found in some receivers, although its use has diminished in recent years. This is shown first. Next is shown the *piezo-electric crystal*, which consists of a specially cut piece of quartz or other special crystal. It is used to keep transmitters in tune and has been used in one special type of receiver to make tuning extremely sharp.

**Switches:** Numerous types of switches have been used in radio receivers; some of the most common are illustrated. The first is the *toggle* switch; second is the *selector* switch; and the third type is the *knife* switch, which may have any number of blades and may have contacts on either one or both sides.

**Fuse:** Two types of fuses are shown:

the screw type such as those used in your house fuse box and the cartridge type. They are both shown by the same symbol.

**Batteries:** The symbol for a battery consists of alternate long and short lines. The long ones indicate the positive pole and the short ones the negative. Three types of batteries used in radio receivers are shown—the storage battery, the dry cell and the "B" battery.

**Phonograph pickup:** The popularity of radio amplifiers for phonograph amplification has created a demand for a symbol covering the *magnetic pickup* employed for coupling the phonograph to the radio. This symbol is shown below the batteries.

**Loudspeakers:** Both magnetic and dynamic speakers are pictured. The magnetic speaker is shown with its permanent magnet and the field-coil or electromagnet of the dynamic speaker is indicated beside the "voice coil." The difference between the two is obvious from the symbols.

**Microphone:** or telephone transmitter which usually takes the form shown in the chart for radio broadcasting and transmitting is shown by a form that resembles the ordinary telephone transmitter and is frequently labeled "mike."

**Jacks:** Three types of phone jacks are depicted. The first is the "single circuit type" which merely provides connections for the headphones. The second type is the "double circuit jack" which disconnects the last tube from the circuit when the phones are used in the detector or first stage. (This method of connection was very popular a few years ago.) The last type is the *filament-control* type that turns off the filament of the power tubes when the phones are inserted in a previous stage.

**Headphones:** The phone symbol is simply a copy of the actual phones and needs no explanation.













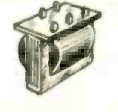

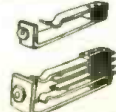















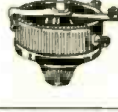
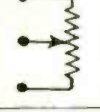



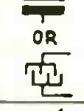
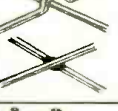



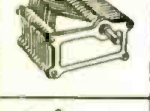

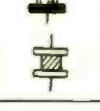



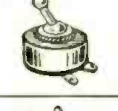
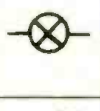
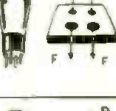
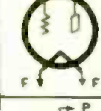
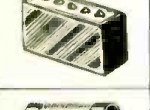





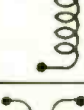
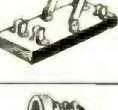

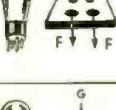



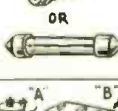



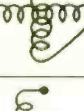

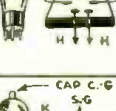
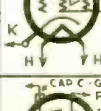

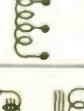



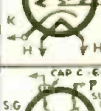

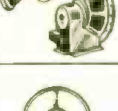
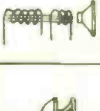
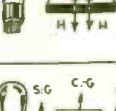
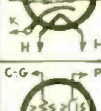

**Voltage Regulator Tube:** In some A.C. receivers a special tube is provided to prevent changes in the voltage of the supply line from affecting the reception or endangering the apparatus. This tube contains a special type of filament as shown in the symbol. It has a two-prong base.

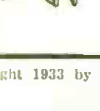
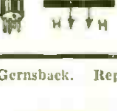
**Terminals:** In the next two sections are shown several devices used to provide connections to parts of the receiver. The first is the "binding post" or terminal which accommodates the end of a wire and connects it to parts of the set. Next we have the phone-tip jack that grips a phone tip and connects it to the output of the set. The third connector is the common power-plug and receptacle found in house wiring.

**Meter:** This is the symbol used to indicate the use of a meter such as a voltmeter, ammeter, milliammeter, etc. The letter indicates the type of the meter—"A" stands for ammeter, "M" for milliammeter, "V" for voltmeter, etc.

**The IDEAL "COMPOSITE" S-W Receiver Embodying the Features Voted for by Our Readers Will Appear in Next Issue Due to Lack of Space in This Number**

# Chart of Radio Symbols

	AERIAL			PUSH-PULL AUDIO TRANSFORMER			SINGLE CIRCUIT JACK	
	LOOP ANTENNA			FIXED RESISTOR			FILAMENT CONTROL JACK	
	GROUND			VARIABLE RESISTOR			HEAD PHONES	
	COUNTER-POISE (CP)			VOLTAGE DIVIDER (POTENTIOMETER)			VOLTAGE REGULATOR TUBE	
	FIXED CONDENSERS			WIRES NOT CONNECTED			LAMP SOCKET PLUG	
	VARIABLE CONDENSER			WIRES CONNECTED			PLUG RECEPTACLE	
	CRYSTAL DETECTOR			CRYSTAL DETECTOR			METER (MAY BE VOLT METER, AMMETER, OHMMETER, MILLIAMMETER, ETC.)	
	CONDENSERS OPERATED ON ONE SHAFT "GANGED"			SWITCH (POWER OR FILAMENT-SINGLE-POLE, SINGLE-THROW SW.)			THREE ELEMENT TUBE ("TRIODE")	
	CONDENSER BLOCK			SINGLE-POLE MULTI-THROW SWITCH			TWO ELEMENT ("DIODE") TUBE RECTIFIER FOR POWER SUPPLY OR DETECTION	
	R.F. COIL (MAY BE R.F. CHOKE)			DOUBLE-POLE DOUBLE-THROW SWITCH			FULL-WAVE RECTIFIER TUBE	
	R.F. COILS COUPLED (R.F. TRANSFORMER)			FUSE			THREE ELEMENT TUBE, A.C. HEATED CATHODE TYPE ("TRIODE")	
	VARIOMETER (CONTINUOUSLY VARIABLE R.F. COIL)			BATTERIES			SCREEN GRID TUBE ("TETRODE")	
	TAPPED R.F. COIL			PHONOGRAPH PICK-UP			VARIABLE-MU SCREEN GRID TUBE	
	AUDIO FREQUENCY COIL (MAY BE A.F. CHOKE)			MAGNETIC SPEAKER			DYNAMIC SPEAKER	
	TRANSFORMER (MAY BE A.F. TRANSFORMER, PWR TRANS. OR FILAMENT TRANS.)			MICROPHONE (TRANSMITTER)			POWER PENTODE TUBE	

# A High-Gain 2-Tube Short-Wave Receiver

By H. V. MacMILLAN

You will find this 2-tube Receiver hard to beat!

● A small broadcast or short-wave receiver that "brings them in" certainly is an asset to the ham or short-wave listener. Here is one that, for sensitivity and audio output, will make many of the big fellows step to beat it, and for simplicity and ease of tuning, is ahead of many.

The writer has built multi-tube superhets and receivers with a stage of tuned radio frequency, and has had the thrill of foreign reception, but no more reaching out qualities than the receiver described herein affords.

The 57 detector is superior to anything yet tried. The 24's, 35's, 36's, 38's, 47's have all been tried and, while the output pentodes may give greater audio output voltage when used as a detector, the new R.F. pentode detector is far ahead in sensitivity to weak signals. A 58 was also tried, but despite its lower plate impedance and higher transconductance, it proved by actual test less sensitive and gave noticeably less volume on all stations.

The 38 was chosen for an output tube because a 41 was not procurable, but a 41 will supplant it when it can be gotten because of the latter's higher amplification factor and power output for practically the same plate impedance. A 47 was tried but put a modulation on the signal, which is probably on account of it being a filament type, while the auto series tubes all have indirectly heated cathodes and are less "hummy."

If the constructor gets his tickler turns about right, smooth regeneration will result, and in fact, a pleasant surprise awaits him who takes the care on the above end and has proper screen voltage on the 57.

The antenna coupler, L1-L2, should be experimented on, for if the proper arrangement is determined, signal strength is greatly increased, as it is a form of antenna tuning. A ground connection on this coupler gave no improvement.

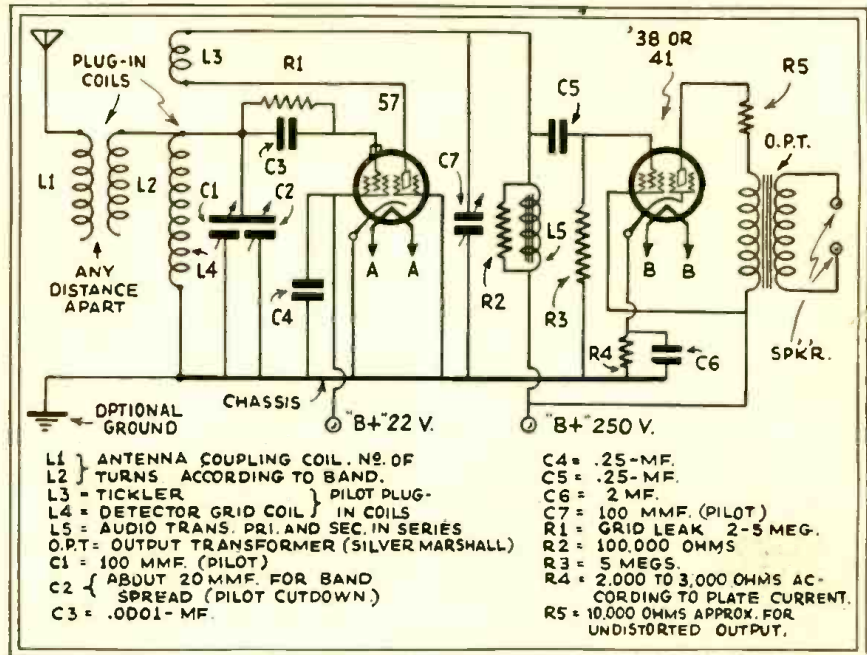

Mr. MacMillan's "High-Gain" 2-Tube Receiver Circuit, the Result of Much Experimentation.

A resistor of 100,000 ohms worked better than anything else across the detector plate impedance, L5.

At R3, the writer encountered no audio howl with leaks up to 5 megohms, but if same is encountered, this value can be decreased.

R4 should be of such a value as to bring the value of plate current to the tube manufacturers' specifications and should be from 2,000 ohms up; condenser C6 is very important if proper volume is to be had. Of course, a small "C" battery can be substituted, in which case, this condenser was not found necessary.

The output transformer used by the writer was not designed for the 238 used, and since the manufacturer's recommendations are for a 13,500 ohm load for best quality at 135 volts, a 10,000-ohm unit, R5, was put in series with the output transformer primary.

It must be remembered that, if a 250 volt plate supply is used, the 238 should

be biased sufficiently to prevent the plate current from being excessive and should not exceed about 10 milliamperes.

No detector plate choke was found necessary, and even with a long antenna, no *dead-spots* appeared from 20 meters all the way up through the broadcast band.

While the receiver has only been in operation a very short time, Pontoise, France, was heard on the loud speaker, as were most of the New York stations on the broadcast band, including Chicago (at my station located about three miles from Boston and one mile from a local broadcast transmitter).

About the filament supply, the writer used a 6 volt "A" eliminator with a resistor to cut down the voltage to 2.5 for the 57. A storage battery or a filament transformer can be used. A shield over the tube is optional. The detector coils should not be shielded because experiments show decreased efficiency with shielding.

## \$20.00 Prize Monthly For Best Set

● THE editors offer a \$20.00 monthly prize for the best short-wave receiver submitted. If your set does not receive the monthly prize you still have a chance to win cash money, as the editors will be glad to pay space rates for any articles accepted and published in SHORT WAVE CRAFT.

You had better write the "S-W Contest Editor," giving him a short description of the set and a diagram, BEFORE SHIPPING THE ACTUAL SET, as it will save time and expense all around. A \$20.00 prize will be paid each month for an article describing the best short-wave receiver, converter, or adapter. Sets should not have more than five tubes and those adapted to the wants of the average beginner are much in demand. Sets must be sent PREPAID and should be

CAREFULLY PACKED in a WOODEN box! The closing date for each contest is sixty days preceding date of issue (April 1 for the June issue, etc.).

The judges will be the editors of SHORT WAVE CRAFT, and Robert Hertzberg and Clifford E. Denton, who will also serve on the examining board. Their findings will be final.

Articles with complete coil, resistor and condenser values, together with diagram, must accompany each entry. All sets will be returned prepaid after publication.

REQUIREMENTS: Good workmanship always commands prize-winning attention on the part of the judges; neat wiring is practically imperative. Other important features

the judges will note are: COMPACTNESS, NEW CIRCUIT FEATURES, and PORTABILITY. The sets may be A.C. or battery-operated, Straight Short-Wave Receivers, Short-Wave Converters, or Short-Wave Adapters. No manufactured sets will be considered; EVERY SET MUST BE BUILT BY THE ENTRANT. Tubes, batteries, etc., may be submitted with the set if desired, but this is not essential. NO THEORETICAL DESIGNS WILL BE CONSIDERED! The set must be actually built and in working order. Employees and their families of SHORT WAVE CRAFT are excluded. Address letters and packages to the SHORT WAVE CONTEST EDITOR, care of SHORT WAVE CRAFT Magazine, 96-98 Park Place, New York, N. Y.

# Newest BOSCH 10-Tube MULTI-WAVE Superheterodyne

This receiver has a clever single-dial control for all waves, the colored scales being changed automatically as the bands are selected. The receiver has, among other features: Silent tuning, automatic noise reducer, "AVC," tone control, dual loud speakers.



Handsome appearance of the new Bosch "World Cruiser," model 260C, 10-tube "all-wave" superheterodyne receiver.

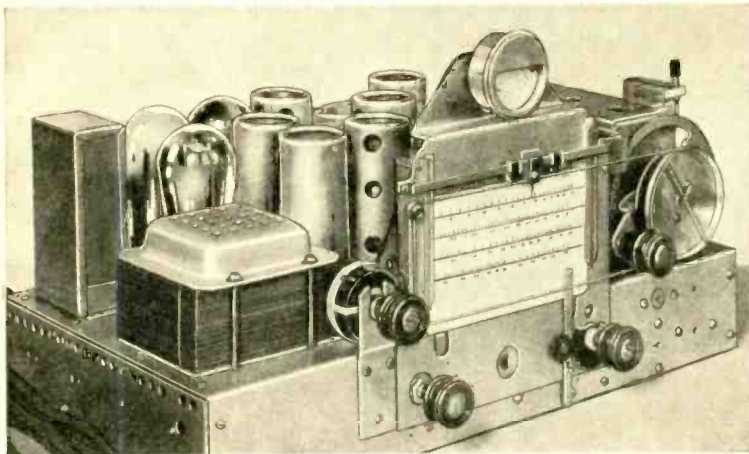

"Close-up" of the 10-tube multi-wave superhet chassis.

provided on all bands; other features include—silent tuning control; true-pitch tone control; properly blended, dual loud speakers; push-pull power-output stage using two 45 type tubes. Following are numerous constants or values of the condensers and resistors used in this new Bosch Multi-Wave Superheterodyne Receiver. Those interested in the values of the coils and tuning condensers in the oscillator and antenna circuits may refer to back numbers of SHORT WAVE CRAFT in which details or constants of such circuits have been repeatedly given.

● ONE of the latest and finely engineered multi-wave receivers is that here illustrated. Whenever one of the various short-wave bands are selected, the operator is automatically notified of the fact by a change in color of the illuminated full-vision scale. A tuning meter, placed just above the main tuning

scale, facilitates and simplifies the tuning operation. Whenever a different frequency band is selected, a different set of antenna and oscillator coils are automatically switched into circuit, so that practically four separate and complete 10-tube receivers are provided in one set. Automatic volume control is

- |                 |                 |
|-----------------|-----------------|
| R1—500,000 ohms | R5—1,500 ohms   |
| R2—5,000 ohms   | R6—1,000 ohms   |
| R3—1,000 ohms   | R7—100,000 ohms |
| R4—100,000 ohms | R8—1,500 ohms   |

(Continued on page 767)

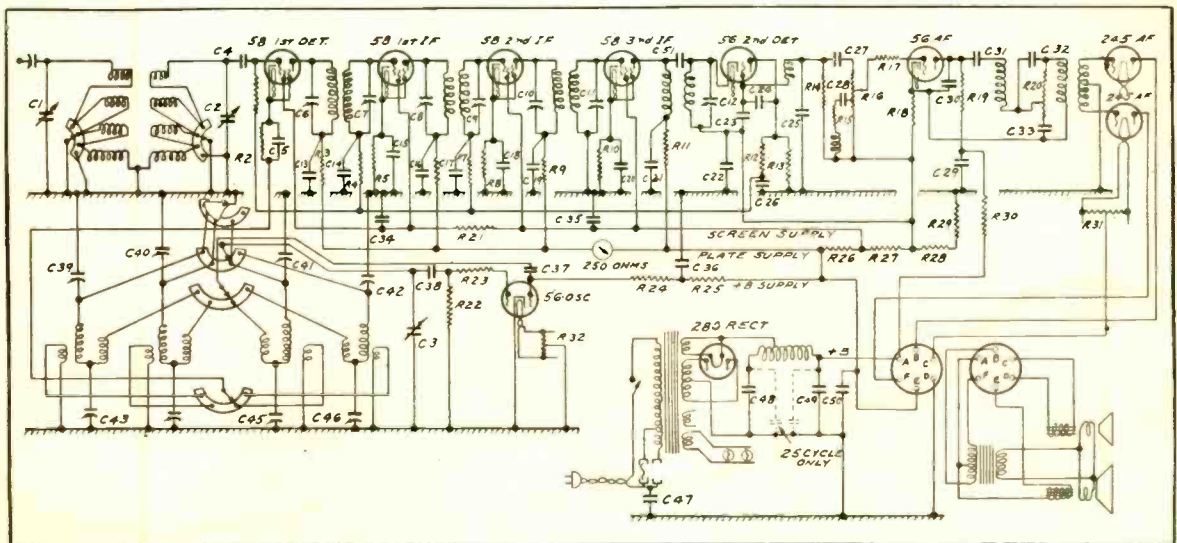

The oscillator and antenna coils are changed for each band, thus providing practically four separate and complete short-wave receivers in one instrument.

# A New Form of Tuning Inductance

By RINALDO DE COLA

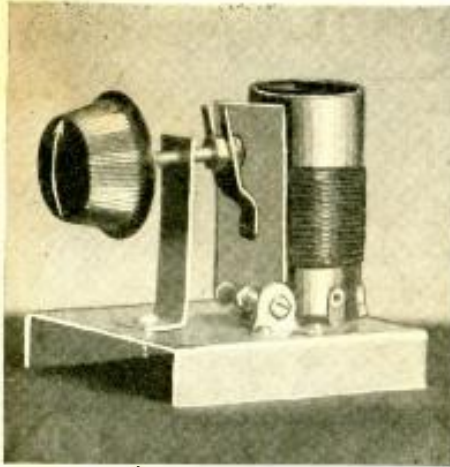

Model of the new combination tuning condenser and inductance built by the author and successfully used in his experiments.

● SHORT-WAVE receivers have been considerably discussed, and various systems proposed for the reception of short-wave amateur and broadcast signals. However, the great drawback in practically all straight regenerative short-wave receivers is the difficulty in tuning because of "dead spots." No satisfactory remedy has as yet been proposed. Systems employing tuning condensers in the antenna system to tune the antenna to different frequencies from that of the received signal, in order to prevent dead spots, have been widely published but have certain definite limitations which it would be desirable to overcome. Much better reception is always obtained with the antenna system tuned to the same frequency as that of the received signal. However, the antenna adjusted to this frequency is the precise position at which dead spots are found. It would be extremely desirable, therefore, to find some method whereby the antenna can be made sharply resonant to the received signal, without in any way disturbing the sensitivity of the receiver into which it works.

## Cause of "Dead Spots"

The phenomenon of "dead spots" usually is most annoying and troublesome with very sensitive receivers, and is particularly dependent upon systems which use regeneration to some extent in order to raise the receiver sensitivity. When a sharply tuned circuit is closely coupled to a regenerating or oscillating current, a high resistance is (in effect) introduced into the circuit, with the result that oscillation or regeneration is completely stopped, resulting in "dead spots."

## A New Tuning Device

All receivers, whether for short or long waves, are tuned by means of lumped variable capacities (variable condensers) or by means of lumped variable inductances (variometers). All inductance coils possess some distributed capacity, that is capacity which exists between the turns of the coil itself, and this capacity merely adds to whatever value of condenser may be placed across it. However, if no condenser were used it would be possible to vary the distributed capacity of the coil to accomplish tuning. This can be accomplished by placing

Something new in a variable tuning inductance is here described by Mr. de Cola. Any short-wave "fan" can build an experimental model of this new tuner in a few minutes; among other features the author recommends it highly for the elimination of "dead spots."

a metal plate close to a coil and by varying the position of this plate with respect to the coil the distributed capacity of the coil is varied and tuning is made possible. This method of tuning was first used by Louis Cohen and he called it "tuning by wave resonance."

## Eliminating "Dead Spots"

If a circuit arrangement such as that shown in Fig. 1 is used, which consists of a "Wave Conductor" or "Wave Resonator" for tuning, the effects of *dead spots* can be completely eliminated, even when the circuit is exactly resonant to the received signal. When the wave-conductor method of tuning is employed energy is always transferred capacitively, and under most conditions inductive coupling is completely absent. Tuning is accomplished by the proximity of the plate P to coil L. The far end of coil L is left open, as shown in Fig. 1. The effect of this plate upon coil L is to change its distributed capacity and of course to change the frequency to which the antenna is tuned. The energy at the far, or free end of L is in the form of a comparatively high voltage and this voltage due to the capacity between the coil and the plate P induces a voltage on P, which can be directly connected to the grid tuning circuit of a tube as shown.

## How New Tuner Acts

In order to obtain some knowledge of just why tuning can be accomplished in this fashion it is necessary to make a study of the diagrams shown in Fig. 2. In Fig. 2-A is shown a straight aerial wire which is left open at both ends. Such an antenna is known as a half wave antenna. Measuring from end to end of this aerial, this length in meters, multiplied by two, represents the resonant wavelength. In order to increase the resonant wavelength of this system the wire would have to be made longer, and the opposite would be true in order to tune to a lower wavelength. At resonance the voltage waves as shown in Fig. 2-A have maximum voltage points at the extreme ends of the aerial. Maximum current would, of course, occur at the center of the system. If the grid of a tube could be brought near either end of this aerial and the tuning circuit across this grid tuned to the same frequency as that of the aerial, strong signals would be received. However, if the received frequency departed even slightly from the fundamental or harmonic frequency of this aerial signals would come in very weakly. In other

words this arrangement makes an extremely sharp means of tuning.

The selectivity of the arrangement is about that of two tuned stages. However, it is impractical to vary the length of the antenna to conform with various signals and some other means must be found of varying the length or resonant frequency of the antenna. The variation in distributed capacity is accomplished by bringing the metal plate P (see Fig. 1 and Fig. 2-B) near

(Continued on page 759)

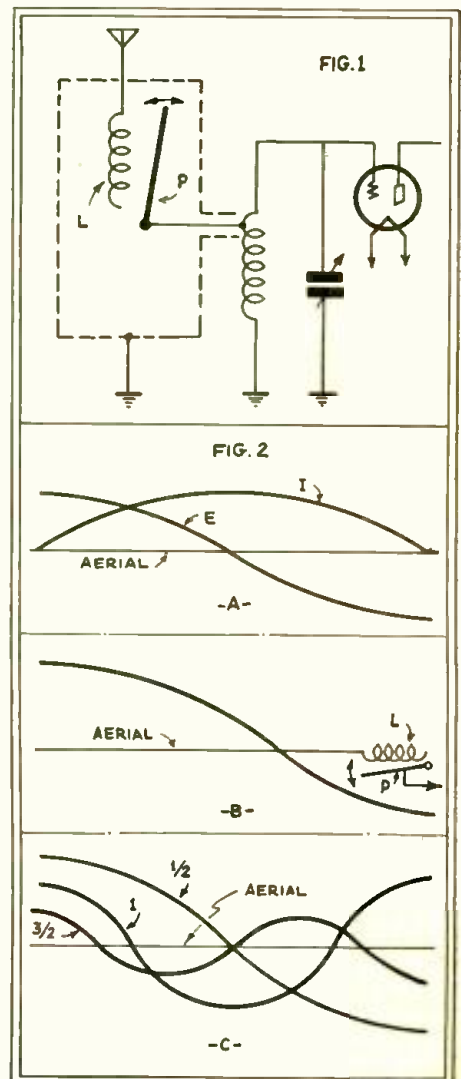
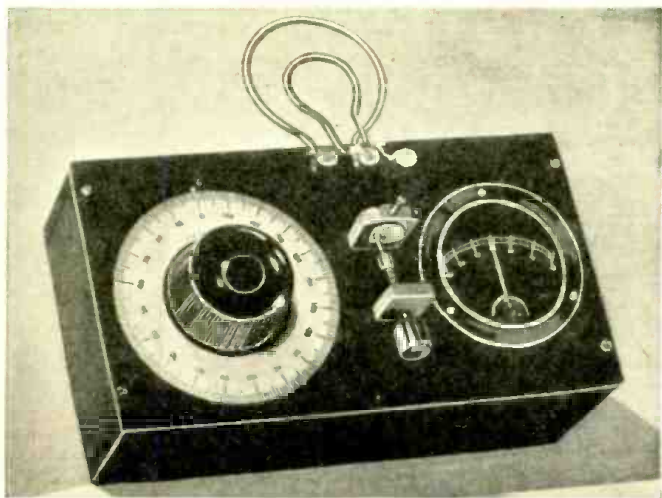

Fig 1, at top, shows typical diagram or hook-up for use with Mr. de Cola's novel new tuner; Curves, below, at Fig. 2, are used by the author in explaining the action of his new tuner.





Appearance of the finished wavemeter, fitted with a crystal detector and galvanometer.

# A Crystal Detector WAVEMETER for Ultra-Short Waves

By C. BRADNER BROWN\*

Mr. Brown describes how to use a crystal detector in place of a thermo-couple in a wavemeter of extreme sensitivity and sharp tuning; also how to calibrate the wavemeter with a Lecher wire system.

THE problem of determining the frequency or wavelength of a radio frequency oscillator depends to some extent on three factors, namely: the accuracy with which the determination is to be made, the frequency of the oscillations, and the power of the oscillator. A wavemeter is a device for measuring wavelength or frequency of a radio wave and consists of a tuned circuit with some means of indicating resonance with the R.F. wave. It has an accuracy which is sufficient for most measurements and is the instrument usually used. If the frequency is to be obtained any more accurately, some source of standard frequency may be compared with the oscillator in question by a beat note method. In general, a wavemeter is used to approximate the wavelength and more precise methods used later.

### Typical Wavemeter Circuit

The standard wavemeter consists of a tuned circuit in which the inductance acts as the pickup coil, and a small flashlight bulb connected in series with the circuit as shown in Fig. 1 at (a) serves as the resonance indicator. The main difficulty with the arrangement is its insensitivity. The lamp necessarily introduces considerable resistance into the tuned circuit and broadens the tuning curve until it is difficult to locate the wave accurately. Furthermore, the eye is not particularly sensitive to variations in light intensity and this further increases the error in reading. It can easily be seen that the power consumption of such a device is rather large. The 6 volt bulb works the best, drawing 300 milliamperes, which represents a power loss of 1.8 watts. Although this does not represent a large power consumption when used with oscillators having a rating of 50 watts or over, it may affect the operation of a low-power oscillator to a considerable extent. This is particularly true of tuned plate tuned grid circuits, which are so commonly used on the ultra short wave bands. The close coupling which is necessary may throw the oscillator off frequency by a rather large amount when operating on waves below five meters.

### Neon Lamp Indicator

The use of a small sized neon lamp in place of the flashlight bulb repre-

sents a considerable improvement, although the voltage required to strike even the 1/4 watt size is large enough to prohibit its use with any but a powerful oscillator. Probably the most satisfactory radio frequency indicator used in wavemeters is the thermo-galvanometer which consists of a sensitive milliammeter deflected by current from a thermo-couple through which the radio frequency flows. The cost of a good thermo-galvanometer is, however, out of reach of the amateur who "makes his own"—hence other methods are generally used, the most accurate being the comparison of the frequency to be measured with that of a standard electron-coupled oscillator by the "beat-note" method.

Although any of the above methods is satisfactory and sufficiently accurate at the lower frequencies, it is quite another problem to determine the wavelength of an oscillator operating below five meters. In the first place, the need for high power appears to have definitely vanished and low-power oscillators produce as strong signals within the receiving range as high-powered. In all probability this is caused by the fact that the signals are lost due to the curvature of the earth long before their strength fails. Thus the indicating instrument should consume as little power as possible in order to affect the oscillator constants as little as can be. If crystal oscillators were practical, part of this necessity would vanish, inasmuch as the frequency of a crystal oscillator is changed but very little when the tank circuit constants are changed. This same holds true for a master-oscillator, power-amplifier hookup, although the advantages of this type of circuit at the high frequencies is rather questionable.

The most accurate method is without a doubt the comparison system, using the harmonics of a much lower frequency oscillator which can be standardized. The difficulty lies in the fact that the test is not easily made, and does not indicate the relative strength of the signal. It cannot be used for indication of nodes and loops in the antenna system and takes considerable time. Although it is admittedly the most accurate method, such accuracy is not necessary when testing high frequency oscillators general-

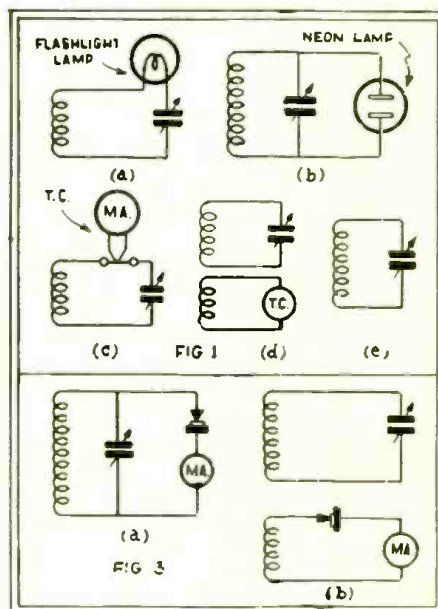

Various wavemeter circuits described in the text.

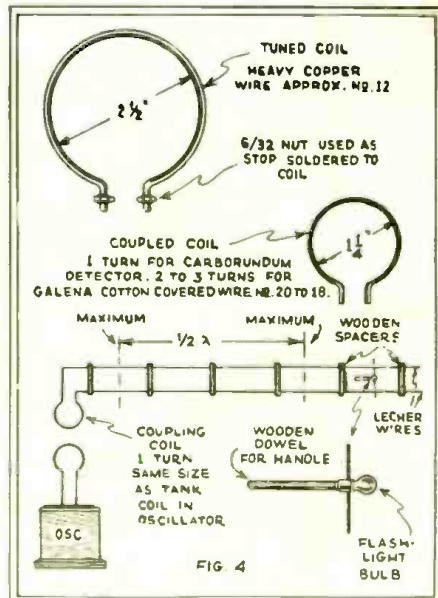

Diagrams above show arrangement of Lecher wire system used in calibrating the wavemeter.

\*Chief Engineer-Experimental Div. First National Television Corp.

(Continued on page 752)

# \$5.00 For Best Short Wave Kink

The Editor will award a five dollar prize each month for the best short-wave kink submitted by our readers. All other kinks accepted and published will be paid for at regular space rates. Look over these "kinks" and they will give you some idea of what the editors are looking for. Send a typewritten or ink description, with sketch, of your favorite short-wave kink to the "Kink" Editor, SHORT WAVE CRAFT.

end of this piece of wire to antenna binding post. Pulling out the brass tube varies the capacity; all this stuff can generally be found in the old "junk box."  
—Ous Leuchte, Jr.

with the regular tuning dial and then using this small condenser, I could bring in distant stations very easy.—William H. House.

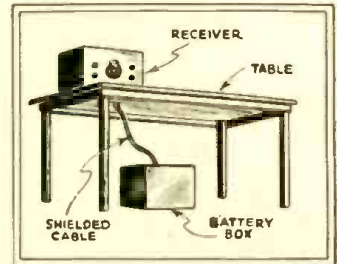

## SHIELDING SET AND BATTERIES

I have a receiver with 230's in a regenerative circuit. To completely shield the receiver with filament supply dry cells and two 45 volt "B" batteries, was out of the question. Therefore I put the receiver proper in an aluminum box, the batteries in an old "bread-box," and ran the connections from the batteries to the set in a three-wire shielded cable. A hole is cut (to just the size of the cable) in the battery and receiver boxes. The shield of the cable is connected to both boxes and one of them is "grounded." All that is necessary to convert the receiver to a monitor is to disconnect the antenna. This method has the advantage of making the receiver neat and small, while still having batteries and yet with all shielded. If the batteries and receiver were in the same box, it would make it much too bulky for my table. The battery box can be dumped behind the table and the connection run up to the receiver.—J. A. Crutchfield, Jr.

## A NOVEL PHONE "CUT-IN"

Here is a novel phone attachment for a modern A.C. dynamic receiver using an SW adapter, that has been in practical use a few months and fulfills all that is claimed for it. As seen in Fig. 1, a pair of phones is inserted in series with the voice coil of the dynamic speaker, and a switch connected across the terminals. The resistance of the voice coil is approximately 15 ohms so it may be seen that the comparatively higher resistance of the phones will cut off the voice frequency currents from the speaker. When the switch shorts the phones, the loud speaker functions normally. A sample set-up is suggested in Fig. 2. It is a knife switch with Fahnestock clips mounted under the poles of the switch. A few of the fine points of this set-up are very inexpensive, simplicity and ease of operation, no blasting or high voltage D.C. through phones, etc. It would be well worth the while of a SW "dyer" to thus obtain ear-phone reception on stations not having

## SMOOTH-ACTING SOCKET

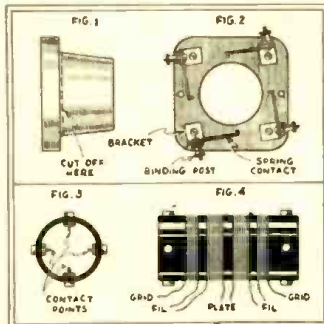

Remove all binding posts, screws and contact springs from an old "LV" socket. Care should be taken that the socket is of bakelite. Cut off the tubular projection flush with the base as in Fig. 1. Then mount four small right angle brackets in the place of the old binding posts; to these fasten the spring contacts that were removed, as shown in Fig. 2. Now you have an extremely "low-loss" mounting. For the coils two pieces of bakelite tubing slightly larger in diameter than the diameter of the hole in the mounting and approximately 3 to 4 inches long are necessary. Fasten four contact points, evenly spaced, at each end of these coil forms, see Fig. 3. By placing the form upright in the mounting a slight turn will close the connection with contacts at bottom of coil form; another slight turn and the coil may be lifted out and reversed for contacts at other end; no more straining or effort to remove a coil. Wind two sets of coils on each form, bringing the ends down inside of form and fastening to proper contact points.

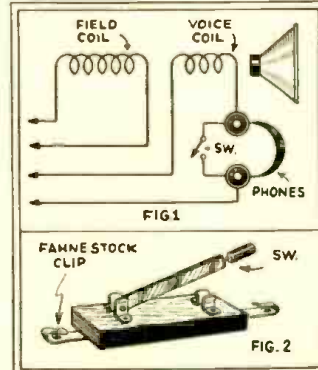

enough volume for the speaker.—B. Fishkin.

## "LOW-COST" GANG SWITCH

The gang switch shown can be made from "junk box" parts; but still give satisfactory service. It consists of nothing more than a strip of scrap bakelite or hard rubber with three sets of contacts and wipers or blades. A small screw is soldered on each wiper to receive the shaft, which is drilled in three places to take the small screws. To change the wavelength of the coils, simply pull or push the knob on the rod. To change coils with this switch is actually simpler than with a commercial switch. If the constructor uses a little ingenuity he can make many refinements over the original idea and incorporate it into various radio receivers and converters. The system is practical for 2 to 6 sets of contacts.—T. A. Blanchard.

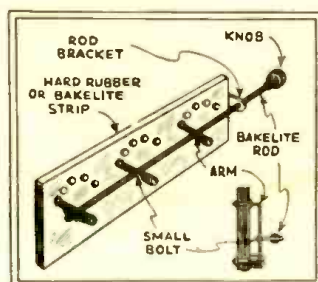

## VERNIER CONDENSER

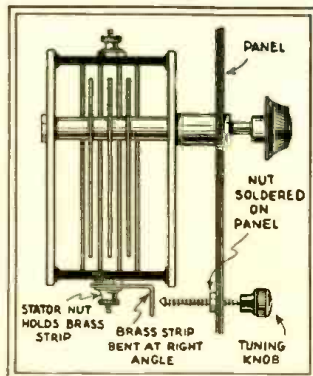

I have a 8-WV set with 3 tubes, using a 7 plate tuning condenser; I had trouble in tuning in some distant stations so I made myself a small condenser to tune sharper, as shown in the drawing. I got a binding post nut of the insulated type and put a screw into it. The screw was an inch long; then, I filed the head of the screw to a point. I drilled a hole in the metal panel and soldered a nut on the back of the panel. The hole in the panel was located so that the screw would more towards the electrode on the stator plates. By tuning in a station as close as I could

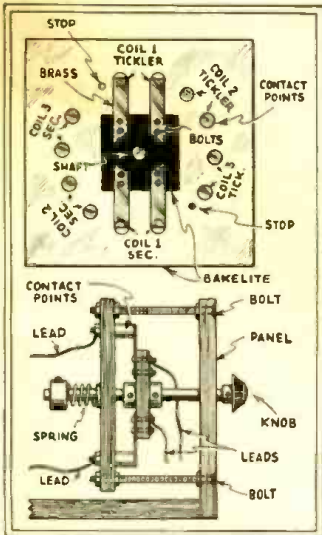

## \$5.00 PRIZE

### PLUG-IN COIL ELIMINATOR

The following is the data for making a plug-in coil eliminator for short wave receivers. Parts needed are 12 contact points, 4 pieces of brass, bakelite 2 1/2" x 2 1/2", square piece of bakelite, knob and shaft, spring and some bolts and nuts. It is made according to the diagram. It is held to the panel with long screws. The switch is held to the shaft with set screws. This one is for 3 coils; if more are needed it is made larger so as to have space for more contact points. For changing coils pull out on the knob and move to next position. Circuit wires are soldered to the brass strips. The coil leads go to the contact points.—A. J. Maus.

## RIBBED COIL FORM

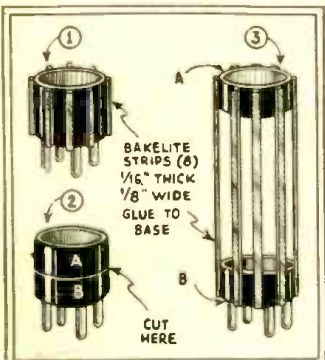

I herewith present my favorite coil form kink. It is the tube base coil form in an improved condition, with ribs, so as to provide a maximum of air dielectric to the coil. Get some bakelite 1/16" thick and cut some strips 1/8" wide; 8 pieces in each base, long enough to reach the full length of the base. If a longer base is wanted, cut the base as shown and proceed to cut some more ribs of bakelite; it might be advisable to use thicker ribs if the coils are very long. To add a touch of color to the forms, use brown bakelite for the ribs. For handles see January issue of Short Wave Craft. Glue ribs in place or slip a rubber band around them to keep them in place while winding coil.—Alfred C. Jensen.

## ANTENNA CONDENSER

Paste a piece of tinfoil around outside of glass of an old grid-leak tube, slip in old fuse clip (small size); you can take one

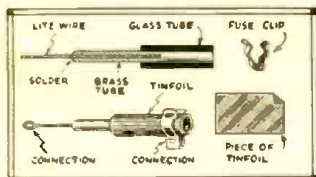

of the connections from the screw that fastens fuse-clip to the base-board. Now, solder a piece of Litz (stranded) wire to a piece of brass tubing that just fits inside of the glass tube; next secure one

## INDUCTANCE INSULATORS

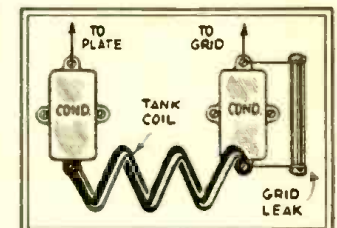

When building a Hartley transmitter, I broke the two insulators used to support the tank coil. Instead I screwed two bakelite fixed condensers to the baseboard and screwed the tank coil onto the ends. As these condensers were necessary as grid and plate blocking condensers I saved space and the cost of two new insulators.—L. Emmett Rhoden.

## HANDLE FOR COILS

This little wrinkle added to a set of tube-base coils improves the appearance and is of definite practical value; it is a convenience in pulling out the coil. It

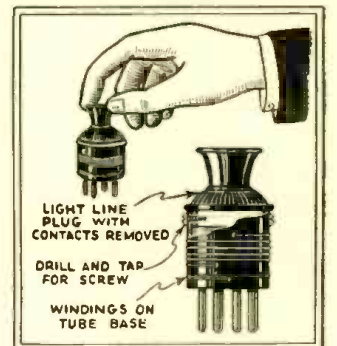

protects the windings from being loosened or pulled off. It does away with the necessity of doping coils; a practice which has been denounced by many successful set designers. Since these outlet plugs can be purchased in four or five colors, the different coils of a set can be distinguished quickly.

The construction is comparatively simple. It consists of an electric fixture such as that shown fastened to the top of a tube base coil. Outlet plugs of the type shown can be purchased at nearly all Five-and-Ten-Cent stores. The two contacts are first removed from the plug. The plug is put in place in the tube base and the two holes drilled. The bolt holes may be threaded or the bolts merely forced in, but with danger of splitting the bakelite.—R. B. Johnstone.

# SHORT WAVE LEAGUE



## HONORARY MEMBERS

Dr. Lee de Forest  
 John L. Reinartz  
 D. E. Replogle  
 Hollis Baird  
 E. T. Somerset  
 Baron Manfred von Ardenne  
 Hugo Gernsback  
*Executive Secretary*

## What Our Readers Think

### That 5-Meter Argument Again!

Editor, SHORT WAVE CRAFT:

Just a few timely words from an "old timer" in the game. To begin with, Mr. Gernsback, I have read your stuff for a good many years, I think since the days of Ralph 124C41+, if I remember rightly, and I have never known you to undertake or sponsor anything that would be detrimental to the amateur profession—so please picture my amazement upon picking up the latest copy of SHORT WAVE CRAFT and finding the League all set to abolish, or have abolished, the "code test."

Man, do you realize that this much discussed code test is the last and only barrier to assist in keeping the few ham bands from pouring over the top? I suppose you listen in once in a while, at any rate? Can you picture what would happen if every Tom, Dick and Harry with sufficient funds were to buy and have set up a fone? Without even the ordinary fundamentals of radio under his hair—can you picture the result?

I'll admit it seems selfish, but it isn't, in any sense of the word. If any young fellow wants to get into this game let him do just as every other ham had to do—some cranium exercise. It probably won't hurt them much and when they have mastered that "terrifying code" they will probably be in a fair condition to begin studying some fundamentals that won't hurt them or the ham bands either. Temple Nieter (W8HPF) expresses this idea most clearly—amateurs of yesterday will be only too glad to assist anyone who really is interested in mastering the code and other necessary requirements, also will be glad to see that the prospect's station comes somewhere near being within the government regulations.

Contrary to the LEAGUE'S idea, the requirements for station and Op's licenses should be stiffened and the code stepped up to 20 per minute. You would agree if you would spend a few hours on 20 or 40 meters trying to get through a msg of some importance. It is bad enough now with about forty per cent of the brass-pounders using their feet, trying to do 30 and yelping QRS to a fairly good 12 in return. Why do anything to make the situation worse, by dropping the barrier for more senseless "CQ" hounds? The game deserves a better fate.

Let the embryonic "hams" gather a few copies of QST and other representative amateur books and glean a bit of common sense to go with them. To my way of thinking, and I'm not alone, anyone who doesn't possess enough intelligence to pass a simple code test doesn't fit in this man's

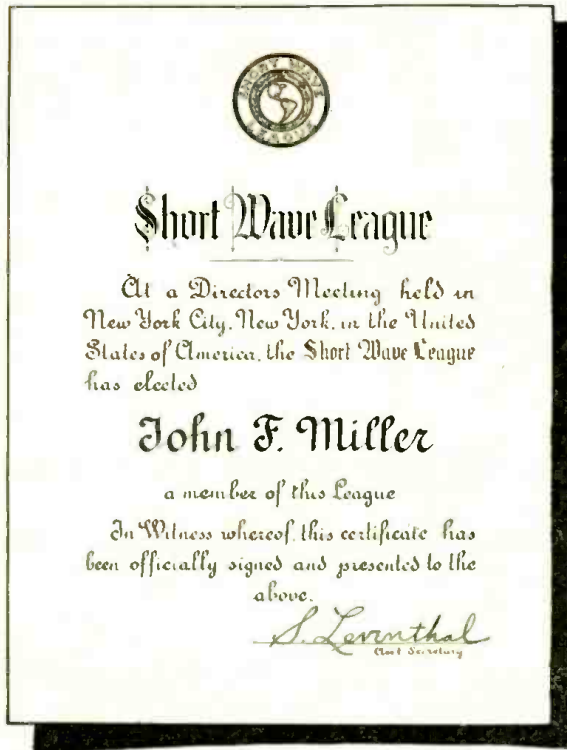

This is the handsome certificate that is presented to all members of the SHORT WAVE LEAGUE. The full size is 7¼"x9½".

game (at least, that's my opinion).  
 Very truly yours,  
 G. W. VIETH,  
 209 E. Carroll St.,  
 City Island, N. Y.

(Thanks, old timer, for your letter. The only fault we have to find is that you evidently did not read the LEAGUE'S platform very carefully. If you will study it again, you will notice that we advocate the dropping of the code test ONLY FOR OPERATORS OF PHONE TRANSMITTERS BELOW SIX METERS. We agree with you perfectly that the bedlam on the higher waves would be made much worse if the license tests were made easier, and in view of the international aspect of short wave radio it would be foolish of us or anyone else to sponsor such a hopeless cause. However, the range of ultra-short-wave transmitters is so limited, and the possibilities of international interference so slight, that a special ruling in regard to this band would be desirable.—Editor.)

### A Few Warning Signals

Editor, SHORT WAVE CRAFT:

I have read the opinions of several hams in the August issue of SHORT WAVE CRAFT and I say here and now, that the way some of the hams are coming on the air is pitiful. The exams should be harder and a much better understanding of the regulations and laws governing an operator's license should be required so that when a ham takes the "exams" there would be no question of doubt as to his ability to operate a station.

Here are some facts that exist now:

- 1—Fellows operating a station with so much AC hum that their signals cannot be heard well enough to read.
- 2—Operating before they have their call letters. (Very bad business.)
- 3—Operating a self-excited rig on fone which is against regulations.

I know these things exist now and what I want to know is how a "ham" could operate in the five meter band when he can't do a good job of it on 160 meters. Another thing to think of is that when you hook up with about two-thirds of the hams via the air they say—"Sure thing, I'm making out your QSL card now." That is one thing that doesn't leave a very pleasant memory when a CQ is given and you hear some fellow coming back to you who has fed you a line and you know you haven't received his card. Be a sport and when you say you are sending a QSL, SEND IT. Don't be dirty and lie about it. Just a penny postcard is better than none.

Well, these are my views and I don't mean maybe, so any of you who don't

(Continued on page 757)

## Get Your Button!

The illustration here shows the beautiful design of the "Official" Short Wave League button, which is available to everyone who becomes a member of the Short Wave League.

The requirements for joining the League were explained in the May issue; copies of rules will be mailed upon request. The button measures ¾ inch in diameter and is inlaid in enamel—3 colors—red, white, and blue.

Please note that you can order your button AT ONCE—SHORT WAVE LEAGUE supplies it at cost, the price, including the mailing, being 35 cents. A solid gold button is furnished for \$2.00 prepaid. Address all communications to SHORT WAVE LEAGUE, 96-98 Park Place, New York.



# SHORT WAVE STATIONS OF THE WORLD

## SECTION ONE

Beginning with this issue of SHORT WAVE CRAFT, the short wave station list that has proved so valuable to readers throughout the world will appear in a new and more convenient form. Previously three pages were set aside in each issue for a complete, composite list, and while this was accurate and contained much good "dope," it admittedly was hard to read because of the necessarily small size type used. We are almost *tripling* the amount of space for this important feature by devoting a total of eight pages to it, with the type larger and more readable.

This month we are running only the short wave broadcasting stations and the experimental and

commercial radiophone stations. Next month the same space will be filled with aeronautical, television, police, press, time and weather stations. The broadcasting and commercial list, with the latest additions and corrections, will reappear in the May issue, and a similarly revised list of the other stations will run in the June issue. We will not stint on space, and will make these lists absolutely the most complete, accurate and dependable in print anywhere. Special reports on new stations, programs, or other events will be featured prominently for the benefit of our readers. The continuous nature of this feature will keep short wave fans in touch with the very latest developments everywhere.

### A Word of Explanation About S. W. Schedules

This list is compiled from many sources, all of which are not in agreement. In fact, conflicting data are received sometimes from the stations themselves. We are constantly writing to stations all over the world and reading reports from hundreds of correspondents. We invite individual listeners to inform us of any stations not listed herewith, or operating on frequencies of hours different from those indicated. All times given are Eastern Standard. Special note: please do not ask us to identify unknown stations from snatches of voice or music. This is utterly impossible. Make a notation of the dial setting and try for the station again until you get an understandable announcement.

## SHORT WAVE BROADCASTING STATIONS

<p><b>21540 kc. W8XK</b> 13.93 meters WESTINGHOUSE ELECTRIC E. Pittsburgh, Pa. 7:30 a. m.-noon</p>	<p><b>15270 kc. W2XE</b> 19.65 meters COLUMBIA BROAD. SYS. Wayne, N. J. Irregular</p>	<p><b>15120 kc. HVJ</b> 19.83 meters VATICAN CITY Rome, Italy Daily 5:00 to 5:15 a. m.</p>	<p><b>12850 kc. W2XCU</b> 23.35 meters AMPERE, N. J. Irregular</p>
<p><b>21470 kc. GSH</b> 13.97 meters BRITISH BROAD. CORP. Daventry, England Irregular</p>	<p><b>15240 kc. FYA</b> 19.68 meters "RADIO COLONIAL" Pontoise (Paris), France Service de la Radiodiffusion, 103 Rue de Grenelle, Paris Daily 8:30-10:00 a. m. Also during late afternoon</p>	<p><b>15120 kc. JIAA</b> 19.83 meters TOKIO, JAPAN Irregular</p>	<p><b>12850 kc. W9XL</b> 23.35 meters ANOKA, MINN., and other experimental relay broadcasters Irregular</p>
<p><b>18830 kc. PLE</b> 15.93 meters BANDOENG, JAVA Wednesdays, 4:00-8:00 a. m.</p>	<p><b>15210 kc. W8XK</b> 19.72 meters WESTINGHOUSE ELECTRIC &amp; MFG. CO. East Pittsburgh, Pa. 7:30 a. m. to 5 p. m.</p>	<p><b>15000 kc. CM6XJ</b> 19.99 meters CENTRAL TUINUCU, CUBA Irregular</p>	<p><b>12820 kc. CNR</b> 23.38 meters DIRECTOR GENERAL Telegraph and Telephone Stations Rabat, Morocco Sun., 7:30-9 a. m. Daily, 5-7 a. m. Telephony</p>
<p><b>17780 kc. W3XAL</b> 16.87 meters NATIONAL BROAD. CO. Bound Brook, N. J. Irregular</p>	<p><b>15210 kc. DJB</b> 19.72 meters For address, see listing for DJA Mondays, 10-11 p. m.</p>	<p><b>14620 kc. XDA</b> 20.50 meters TRENDS-NEWS AGENCY Mexico City 2:30-3 p. m.</p>	<p><b>11905 kc. FYA</b> 25.16 meters "RADIO COLONIAL" Pontoise, Paris. See listing for 19.68 meters. Daily 1:00-2:00 p. m.</p>
<p><b>17780 kc. W9XF</b> 16.87 meters DOWNERS GROVE, ILL. Irregular</p>	<p><b>15140 kc. GSF</b> 19.81 meters Daventry, England</p>	<p><b>13940 kc.</b> 21.50 meters UNIVERSITY OF BUCHAREST Bucharest, Roumania 2-5 p. m., Wed. and Sat.</p>	<p><b>11880 kc. W9XF</b> 25.24 meters NATIONAL BROADCASTING CO. Downers Grove (Chicago), Ill. 9-10 p. m. daily</p>
<p><b>17770 kc. GSG</b> 16.88 meters DAVENTRY, ENGLAND Irregular</p>		<p><b>12850 kc. W2XO</b> 23.35 meters GENERAL ELECTRIC CO. Schenectady, N. Y. Antipodal program 9 p. m. Mon. to 3 a. m. Tues. Noon to 5 p. m. on Tues., Thurs. and Sat.</p>	
<p><b>15330 kc. W2XAD</b> 19.56 meters GENERAL ELECTRIC CO. Schenectady, N. Y. 3:00-6:00 p. m. daily 1:00-6:00 p. m. Sat. and Sun.</p>			

# SHORT WAVE BROADCASTING STATIONS

**11870 kc. VUC**  
25.26 meters  
CALCUTTA, INDIA  
9:45-10:45 p. m.; 8-9 a. m.

**11870 kc. W8XK**  
25.26 meters  
WESTINGHOUSE ELECTRIC  
East Pittsburgh, Pa.  
4-10 p. m.

**11865 kc. GSE**  
25.28 meters  
DAVENTRY, ENGLAND  
7:30-9:30 p. m.

**11840 kc. W9XAO**  
25.34 meters  
CHICAGO FEDERATION OF  
LABOR  
Chicago, Ill.  
7-8 a. m., 1-2, 4-5:30, 6-7:30 p. m.

**11830 kc. W2XE**  
25.36 meters  
COLUMBIA BROADCASTING SYS.  
Wayne, N. J.  
Irregular

**11810 kc. I2RO**  
25.4 meters  
"RADIO ROMA NAPOLI"  
Rome, Italy  
Daily, 11:30 a. m. to 12:15 p. m.  
and 2:00-6:00 p. m. Sunday, 11:00  
a. m.-12:15 p. m.

**11800 kc. VE9CW**  
25.42 meters  
W. A. SHANE, CHIEF ENGINEER  
Bowmanville, Canada  
Daily, 1-4 p. m.

**11790 kc. WIXAL**  
25.45 meters  
BOSTON, MASS.  
Irregular

**11780 kc. VE9DR**  
25.47 meters  
DRUMMONDVILLE, QUEBEC  
Canada  
Irregular

**11760 kc. XDA**  
25.50 meters  
TRENDS-NEWS AGENCY  
Mexico City  
3-4 p. m.

**11750 kc. GSD**  
25.53 meters  
BRITISH BROAD. CORP.  
Daventry  
3:30-5:30 p. m., 11:00 p. m.—1:00  
a. m., 1:30-3:30 a. m.

**11750 kc. VE9JR**  
25.53 meters  
WINNIPEG, CANADA  
Weekdays, 5:30-7:30 p. m.

**11705 kc. FYA**  
25.6 meters  
"RADIO COLONIAL"  
Pontoise (Paris)  
See listing for 19.68 meters  
Daily, 3:00-7:00 p. m.

**10250 kc. TI4**  
29.30 meters  
AMONDO CESPEDES MARIN  
Heredia, Costa Rica  
Mon. and Wed., 7:30 to 8:30 p.  
m.; Thurs. and Sat., 9:00 to 10  
p. m.

**9860 kc. EAQ**  
30.4 meters  
TRANSRADIO ESPANOLA  
Alcala 43-Madrid, Spain  
(P. O. Box 951)  
Daily for America, 5:00-8:00 p. m.;  
for Europe and Canaries on Sat-  
urdays only, 1:00-3:00 p. m.

**9640 kc. HSP2**  
31.10 meters  
BROADCASTING SERVICE  
Post and Telegraph Department  
Bangkok, Siam  
9-11 a. m., daily

**9590 kc. VK2ME**  
31.28 meters  
AMALGAMATED WIRELESS, Ltd.  
Sydney, Australia  
Sun., 1-3 a. m., 5-9 a. m., 9:30-  
11:30 a. m.

**9585 kc. GSC**  
31.29 meters  
BRITISH BROAD. CORP.  
Daventry, England  
2:30-4:30 p. m., 7:30-9:30 p. m.,  
11:00 p. m.-1:00 a. m., 1:30-3:30  
a. m.

**9580 kc. W3XAU**  
31.30 meters  
BYBERRY, PA.  
relays WCAU daily

**9570 kc. WIXAZ**  
31.33 meters  
WESTINGHOUSE ELECTRIC &  
MFG. CO.  
Springfield, Mass.  
6 a. m.-10 p. m., daily

**9570 kc. SRI**  
31.33 meters  
POZNAN, POLAND  
Tues., 1:45-4:45 p. m., Thursday,  
1:30-8 p. m.

**9560 kc. DJA**  
31.38 meters  
REICHSPOSTZENTRALAMT  
11-15 Schoenberge Strasse (Berlin),  
Konigswusterhausen, Germany  
Daily, 8 a. m.-7:30 p. m.

**9550 kc. HBL**  
31.43 meters  
LEAGUE OF NATIONS  
Geneva, Switzerland  
8:00-8:45 a. m., 5:00-5:45 p. m.

**9530 kc. W2XAF**  
31.48 meters  
GENERAL ELECTRIC CO.  
Schenectady, N. Y.  
5-11 p. m., daily

**9520 kc. OXY**  
31.49 meters  
SKAMLEBOEK, DENMARK  
2-7 p. m. daily

**9510 kc. GSB**  
31.54 meters  
BRITISH BROAD. CORP.  
Daventry, England  
8:00-10:00 p. m.

**9510 kc. VK3ME**  
31.55 meters  
AMALGAMATED WIRELESS, Ltd.  
167-169 Queen St., Melbourne,  
Australia  
Wed., 5:00-6:30 a. m., Sat., 5:00-  
7:00 a. m.

**9460 kc.**  
31.70 meters  
RADIO CLUB OF BUENOS AIRES,  
ARGENTINA

**9375 kc. EH9OC**  
32.00 meters  
BERNE, SWITZERLAND  
3-5:30 p. m.

**9290 kc.**  
32.26 meters  
RABAT, MOROCCO  
3-5 p. m., Sunday, and irregularly  
weekdays

**8570 kc. RV15**  
35.00 meters  
FAR EAST RADIO STATION  
Khabarovsk, Siberia  
5-7:30 a. m.

**7530 kc.**  
39.80 meters  
"EL PRADO"  
Riobamba, Ecuador  
Thurs., 9-11 p. m.

**7500 kc.**  
40.00 meters  
"RADIO-TOURNAINE"  
France  
Irregular

**7460 kc. YR**  
40.20 meters  
LYONS, FRANCE  
Daily except Sun., 10:30 to 1:30  
a. m.

**7410 kc.**  
40.50 meters  
EBERSWALDE, GERMANY  
Mon., Thurs., 1-2 p. m.

**7320 kc. ZTJ**  
40.90 meters  
JOHANNESBURG, SO. AFRICA  
9:30 a. m.-2:30 p. m.

**7370 kc. X26A**  
40.70 meters  
NUEVO LAREDO, MEXICO

9-10 a. m.; 11 a. m.-noon; 1-2;  
4-5; 7-8 p. m. Tests after mid-  
night. I. S. W. C. programs 11  
p. m.

**7230 kc. DOA**  
41.46 meters  
DOEBERTIZ, GERMANY  
Irregular

**7220 kc. HB9D**  
41.50 meters  
ZURICH, SWITZERLAND  
1st and 3rd Sundays at 7 a. m.,  
2 p. m.

**7195 kc. VSIAB**  
41.67 meters  
SINGAPORE, S. S.  
Mon., Wed. and Fri., 9:30-11 a. m.

**7140 kc. HKX**  
42.00 meters  
BOGOTA, COLOMBIA  
Irregular

**7020 kc. EAR125**  
42.70 meters  
MADRID, SPAIN  
Irregular

**6990 kc. CTIAA**  
42.90 meters  
LISBON, PORTUGAL  
Fridays, 5-7 p. m.

**6875 kc. F8MC**  
43.60 meters  
CASABLANCA, MOROCCO  
Sun., Tues., Wed., Sat.

**6425 kc. W9XL**  
46.70 meters  
ANOKA, MINN.  
Irregular

**6425 kc. W3XL**  
46.70 meters  
NATIONAL BROADCASTING CO.  
Bound Brook, N. J.  
Relays WJZ. Irregular

**6420 kc. RV62**  
46.72 meters  
MINSK, U. S. S. R.  
Irregular

**6380 kc. HC1DR**  
47.00 meters  
QUITO, ECUADOR  
8-11 p. m.

**6335 kc. VE9AP**  
47.35 meters  
DRUMMONDVILLE, CANADA  
Irregular

# SHORT WAVE BROADCASTING STATIONS

## 6335 kc. CN8MC

47.35 meters  
CASABLANCA, MOROCCO  
Mon., 3-4 p. m., Tues., 7-8 a. m.,  
3-4 p. m. Relays Rabat.

## 6270 kc. HKC

47.81 meters  
BOGOTA, COLOMBIA  
8:30-11:30 p. m.

## 6250 kc. HKA

48.00 meters  
BARRANQUILLA, COLOMBIA  
8-10 p. m. ex. Mon., Wed., Fri.

## 6140 kc. W8XK

48.86 meters  
WESTINGHOUSE ELECTRIC &  
MFG. CO.  
East Pittsburgh, Pa.  
5 p. m.-midnight.

## 6120 kc. W2XE

48.99 meters  
COLUMBIA BROADCASTING SYS.  
485 Madison Ave., New York, N.Y.  
7:00 a. m. to midnight

## 6120 kc. FL

48.99 meters  
EIFFEL TOWER, PARIS  
5:30-5:45 a. m., 5:45-12:30, 4:15-  
4:45 p. m.

## 6120 kc. YV1BC

48.99 meters  
CARACAS, VENEZUELA  
8:00-10:00 p. m. nightly

## 6110 kc. VE9CG

49.10 meters  
CALGARY, ALTA., CANADA

## 6100 kc. W3XAL

49.15 meters  
NATIONAL BROADCASTING CO.  
Bound Brook, N. J.  
Irregular

## 6100 kc. VE9CF

49.15 meters  
HALIFAX, N. S., CANADA  
6-10 p. m., Tues., Thurs., Fri.

## 6095 kc. VE9GW

49.17 meters  
BOWMANVILLE, ONTARIO, CAN.  
5:00 p. m. to midnight

## 6100 kc. W9XF

49.18 meters  
DOWNERS GROVE, ILL.

## 6070 kc. VE9CS

49.40 meters  
VANCOUVER, B. C., CANADA  
Fridays before 1:30 a. m. Sun-  
days, 2 and 10:30 p. m.

## 6080 kc. W9XAA

49.31 meters  
CHICAGO FEDERATION OF  
LABOR  
Chicago, Ill.

6-7 a. m., 7-8 p. m., 9:30-10:15, 11-  
12 p. m. Int. S.-W. Club pro-  
grams. From 10 p. m. Saturday to  
6 a. m. Sunday.

## 6070 kc. JB

49.40 meters  
JOHANNESBURG, SOUTH  
AFRICA  
10:30 a. m.-3:30 p. m.

## 6065 kc. SAJ

49.46 meters  
MOTALA, SWEDEN  
6:30-7 a. m., 11 a. m. to 4:30  
p. m.

## 6060 kc. W8XAL

49.50 meters  
CROSBLEY RADIO CORP.  
Cincinnati, O.

Relays 6:30-10 a. m., 1-3 p. m.,  
6 p. m. to 2 a. m. daily. Sunday  
after 1 p. m.

## 6060 kc. VQ7LO

49.50 meters  
IMPERIAL AND INTERNATIONAL  
COMMUNICATIONS, Ltd.  
Nairobi, Kenya, Africa

Monday, Wednesday, Friday, 11  
a. m.-2:30 p. m.; Tuesday, Thurs-  
day, 11:30 a. m.-2:30 p. m. Satur-  
day, 11:30 a. m.-3:30 p. m.; Sun-  
day, 11 a. m.-1:30 p. m.; Tuesday,  
3 a. m.-4 a. m.; Thursday, 8 a. m.-  
9 a. m.

## 6060 kc. W3XAU

49.50 meters  
BYBERRY, PA.  
Relays WCAU

## 6050 kc. GSA

49.58 meters  
BRITISH BROAD. CORP.  
Daventry, England  
8:00-10:00 p. m.

## 6050 kc. VE9CF

49.59 meters  
HALIFAX, N. S., CANADA  
11 a. m.-noon, 5-6 p. m. On Wed.,  
8-9; Sun., 6:30-8:15 p. m.

## 6040 kc. PK3AN

49.67 meters  
SOURABAYA, JAVA  
6-9 a. m.

## 6040 kc. W4XB

49.67 meters  
LAWRENCE E. DUTTON  
care Isle of Dreams Broadcast  
Corp., Miami Beach, Fla.  
until 10:00 p. m.

## 6030 kc. VE9CA

49.75 meters  
CALGARY, ALTA., CANADA

## 6005 kc. VE9DR

49.96 meters  
CANADIAN MARCONI CO.  
Drummondville, Quebec  
6-10 p. m. daily.

## 6005 kc.

EIFFEL TOWER, PARIS, FRANCE  
Testing, 6:30 to 6:45 a. m.; 1:15 to  
1:30, 5:15 to 5:45 p. m., around  
this wave.

## 6005 kc. VE9CU

CALGARY, CANADA  
Irregular

## 6000 kc.

49.97 meters  
ADMINISTRATION DES P. T. T.  
Tananarive, Madagascar  
Tues., Wed., Thurs., Fri., 9:30-11:30  
a. m. Sat. and Sun., 1-3 p. m.

## 6000 kc. RV59

49.97 meters  
RADIO MOSCOW, U. S. S. R.  
Heard on Sunday afternoons, 3:00-  
5:00 p. m.

## 5970 kc. HVJ

50.26 meters  
VATICAN CITY (ROME)  
2-2:15 p. m., daily. Sun., 5-5:30  
a. m.

## 5900 kc. HKO

50.80 meters  
MEDELLIN, COLOMBIA  
8-11 p. m., except Sunday

## 5835 kc. HKD

51.40 meters  
BARRANQUILLA, COLOMBIA  
7:45-10:30 p. m., Mon.; Wed., 8-  
10:30 p. m.; Sunday, 7:45-8:30  
p. m. Elias J. Pellet.

## 5710 kc. VE9CL

52.50 meters  
WINNIPEG, CANADA  
Irregular

## 5550 kc. W8XJ

54.02 meters  
COLUMBUS, OHIO

## 5170 kc. OK1MPT

58.00 meters  
PRAGUE, CZECHOSLOVAKIA  
1-3:30 p. m., Tues. and Fri.

## 5170 kc. PMY

58.00 meters  
BANDOENG, JAVA  
Irregular

## 5170 kc. PMB

58.00 meters  
SOURABAYA, JAVA  
Irregular

## 4975 kc. W2XV

60.30 meters  
RADIO ENGINEERING LABORA-  
TORIES, Inc.  
Long Island City, N. Y.  
Irregular

## 4795 kc. W9XAM

62.56 meters  
ELGIN, ILL.  
(Time signals.)

## 4795 kc. W3XZ

62.56 meters  
WASHINGTON, D. C.  
Irregular

## 4795 kc. W9XL

62.56 meters  
CHICAGO, ILL.  
Irregular

## 4430 kc. DOA

67.45 meters  
DOEBERITZ, GERMANY  
6-7 p. m., 2-3 p. m., Mon., Wed.,  
Fri.

## 4280 kc. OHK2

70.00 meters  
VIENNA, AUSTRIA  
Sun., first 15 minutes of hour from  
1 to 7 p. m.

## 4273 kc. RV15

70.20 meters  
FAR EAST RADIO STATION  
Khabarovsk, Siberia  
Daily, 3-9 a. m.

## 3750 kc. F8KR

80.00 meters  
CONSTANTINE, TUNIS, AFRICA  
Mon. and Fri.

## 3750 kc. I3RO

84.24 meters  
PRATO EMERALDO,  
Rome, Italy  
Daily, 3-5 p. m.

## 3620 kc. DOA

82.90 meters  
DOEBERITZ, GERMANY

## 3560 kc. OZ7RL

84.24 meters  
COPENHAGEN, DENMARK  
Tues. and Fri. after 6 p. m.

## 2342 kc. W7XAW

128.09 meters  
FISHER'S BLEND, INC.,  
Fourth Ave. and University St.  
Seattle, Washington

# EXPERIMENTAL AND COMMERCIAL STATIONS

<p><b>31000 kc. W8XI</b> 9.68 meters PITTSBURGH, PA.</p>	<p><b>20680 kc. FSR</b> 14.50 meters PARIS-SAIGON PHONE</p>	<p><b>18620 kc. GBJ</b> 16.10 meters BODMIN, ENGLAND Telephony with Montreal</p>	<p><b>17640 kc. Ship.</b> 17.00 meters SHIP Phones to Shore WSBN, "Leviathan" GFWV, "Majestic" GLSQ, "Olympic" GDJL, "Homer" GMJQ, "Belgenland" Work on this and higher channels</p>
<p><b>27800 kc. W6XD</b> 10.79 meters PALO ALTO, CALIF. M. R. T. Co.</p>	<p><b>20620 kc. PMB</b> 14.54 meters Bandoeng, Java After 4 a. m.</p>	<p><b>18620 kc. GBU</b> 16.11 meters RUGBY, ENGLAND</p>	
<p><b>25960 kc. G5SW</b> 11.55 meters CHELMSFORD, ENGLAND Experimental</p>	<p><b>20140 kc. DWG</b> 14.89 meters NAUEN, GERMANY Tests 10 a.m.-3 p. m.</p>	<p><b>18370 kc. PMC</b> 16.33 meters BANDOENG, JAVA.</p>	<p><b>17380 kc. JIAA</b> 17.25 meters TOKIO, JAPAN</p>
<p><b>25700 kc. W2XBC</b> 11.67 meters NEW BRUNSWICK, N. J.</p>	<p><b>19950 kc. LSG</b> 15.03 meters MONTE GRANDE, ARGENTINA From 7 a. m. to 1 p. m. Telephony to Paris and Nauen (Berlin)</p>	<p><b>18350 kc. WND</b> 16.35 meters DEAL BEACH, N. J. Transatlantic telephony</p>	<p><b>17300 kc. W8XL</b> 17.34 meters DAYTON, OHIO</p>
<p><b>24000 kc. W6XQ</b> 12.48 meters SAN MATEO, CALIF. Mon., Wed., Sat.</p>	<p><b>19950 kc. DIH</b> 15.03 meters NAUEN, GERMANY</p>	<p><b>18310 kc. GBS</b> 16.38 meters RUGBY, ENGLAND Telephony with New York General Postoffice, London</p>	<p><b>17300 kc. W6XAJ</b> 17.34 meters OAKLAND, CALIF.</p>
<p><b>21420 kc. W2XDJ</b> 14.00 meters DEAL, N. J. And other experimental stations</p>	<p><b>19906 kc. LSG</b> 15.07 meters MONTE GRANDE, ARGENTINA 8-10 a. m.</p>	<p><b>18310 kc. FZS</b> 16.38 meters SAIGON, INDO-CHINA 1 to 3 p. m. Sundays</p>	<p><b>17300 kc. W9XL</b> 17.34 meters ANOKA, MINN. And other experimental stations</p>
<p><b>21400 kc. WLO</b> 14.01 meters AMERICAN TELEPHONE &amp; TELE- GRAPH CO. Lawrence, N. J. Transatlantic phone</p>	<p><b>19850 kc. WMI</b> 15.10 meters DEAL, N. J.</p>	<p><b>18240 kc. FRO, FRE</b> 16.44 meters ST. ASSISE, FRANCE</p>	<p><b>17110 kc. WOO</b> 17.52 meters DEAL, N. J. Transatlantic phone</p>
<p><b>21130 kc. LSM</b> 14.15 meters MONTE GRANDE, ARGENTINA</p>	<p><b>19830 kc. FTD</b> 15.12 meters ST. ASSISE, FRANCE</p>	<p><b>18170 kc. CGA</b> 16.50 meters DRUMMONDVILLE, QUEBEC CANADA Telephony to England</p>	<p><b>17110 kc. W2XDO</b> 17.52 meters OCEAN GATE, N. J. A. T. &amp; T. Co.</p>
<p><b>21020 kc. LSN</b> 14.27 meters (Hurlingham), Buenos Aires, Argentina</p>	<p><b>19400 kc. FRO, FRE</b> 15.45 meters ST. ASSISE, FRANCE</p>	<p><b>18100 kc. GBK</b> 16.57 meters BODMIN, ENGLAND</p>	<p><b>17080 kc. GBC</b> 17.55 meters RUGBY, ENGLAND</p>
<p><b>21000 kc. OKI</b> 14.28 meters PODEBRADY, CZECHOSLOVAKIA</p>	<p><b>19300 kc. FTM</b> 15.55 meters ST. ASSISE, FRANCE 10 a. m. to noon</p>	<p><b>18050 kc. KQJ</b> 16.61 meters BOLINAS, CALIF</p>	<p><b>16300 kc. PCL</b> 18.40 meters KOOTWIJK, HOLLAND Works with Bandoeng from 7 a.m.</p>
<p><b>20710 kc. LSY</b> 14.47 meters MONTE GRANDE, ARGENTINA Daily 3-6 p. m., Sunday, 10 p. m.</p>	<p><b>19240 kc. DFA</b> 15.58 meters NAUEN, GERMANY</p>	<p><b>17850 kc. PLF</b> 16.80 meters BANDOENG, JAVA ("Radio Malabar")</p>	<p><b>16300 kc. WLO</b> 18.40 meters LAWRENCE, N. J.</p>
<p><b>20680 kc. LSN</b> 14.50 meters MONTE GRANDE, ARGENTINA after 10:30 p. m. Telephony with Europe</p>	<p><b>19220 kc. WNC</b> 15.60 meters DEAL, N. J.</p>	<p><b>17850 kc. W2XAO</b> 16.80 meters NEW BRUNSWICK, N. J.</p>	<p><b>16200 kc. FZR</b> 18.50 meters SAIGON, INDO-CHINA</p>
<p><b>20680 kc. LSX</b> 14.50 meters BUENOS AIRES Telephony with U. S.</p>	<p><b>18820 kc. PLE</b> 15.94 meters BANDOENG, JAVA. 8:40-10:40 a. m. Phone service to Holland</p>	<p><b>17830 kc. PCV</b> 16.82 meters KOOTWIJK, HOLLAND 9:40 a. m. Sat.</p>	<p><b>16150 kc. GBX</b> 18.56 meters RUGBY, ENGLAND</p>
		<p><b>17780 kc. W8XK</b> 16.87 meters WESTINGHOUSE ELECTRIC AND MFG. CO. Saxonburg, Pa.</p>	<p><b>16060 kc. NAA</b> 18.68 meters U. S. NAVY, ARLINGTON, VA. Time signals, 11:57 to noon</p>

To Be Concluded in May Number

# LETTERS FROM S-W FANS

## AMLIE RECEIVER A HIT!

Editor, SHORT WAVE CRAFT:

A short while ago I wrote to Mr. Oliver Amlie of Philadelphia in regard to his DX short wave radio set. I received instructions to build it and I have had great results with it.

Your magazine can't be beat for radio news and I think it is only fair that you give this DX Amlie receiver credit. This set works to the letter and I can vouch for that. Have had Caracas, Venezuela, every night on the loud speaker. It comes in like a "local."

ELDON H. STROBECK,  
172 Perkins Ave.,  
Campello, Mass.

(Glad to hear from you, Eldon, and we are pleased to report that we have had quite a flock of letters from satisfied readers who built up Oliver Amlie's receiver circuit, described in the May, 1932 issue of SHORT WAVE CRAFT. Hearing the Caracas station in South America on the loud-speaker nightly, as happened in your case, is a very fine recommendation for the Amlie receiver. As it only uses 3 tubes, this brings even greater credit to the Amlie set.—Editor.)

## POLICE THRILL BOX THRILLS!

Editor, SHORT WAVE CRAFT:

I have built the "Police Thrill Box" from the May, 1932 issue of SHORT WAVE CRAFT magazine. The results are wonderful! I had police calls all over the country. As you know, too much on one thing is not so good, so I would like to know if I could do something to receive from 25 to 125 meters. I would like to get a little music on short waves and police calls.

WILLIAM A. MILLER,  
256 Lathrop St.,  
Buffalo, N. Y.

(In answer to your letter containing the interesting news that you have had such fine results with the "Police Thrill Box," described in the May, 1932 issue of SHORT WAVE CRAFT, we would suggest that you look through some of the back numbers of this magazine, in which you will find various short-wave converters and adapters described, which will bring in short-wave stations on all wavelengths from 15 up to 200 meters. You can, of course, wind a different coil with a smaller number of turns on it, which will permit the Police Thrill Box to bring in waves below 125 meters. You will find data given in practically every issue on the various number of turns to wind on the coils for different wave bands; with a little experimenting, you should be able to bring in most anything you would want with these changes.—Editor.)

## LOGS 1,231 STATIONS!

Editor, SHORT WAVE CRAFT:

I am writing this letter to thank you for getting me started in the short wave game. I have built a few receivers described in SHORT WAVE CRAFT, such as the "Doerle," "Pocket Receiver," and "The Brief Case Receiver." They worked so well that I sold them and received enough money to buy a good short-wave converter. It is a Stewart-Warner and I use it ahead of a Silver-Marshall broadcast receiver. This converter was described in the December, 1931-January, 1932 issue of SHORT WAVE CRAFT. Among the stations I have logged are I2RO, FYA, G5SW, HKD, YVQ, VE9JR, VE9DR, VE9GW, W4XB and numerous other American stations. I have received "hams" in all districts in United States and a few in Canada on 75 meters. All districts have been received before 12:00 p. m. What do you think of my list? I would like to correspond with anybody, "fans," "hams," "DX'ers," or what have you. All mail will be answered, positively, so bring on your

letters. Here's hoping you publish it in your magazine. Thank you.

ELMER NEUMAN,  
2224 Woodstock Ave.,  
Swissvale, Pa.

P. S.—My log contains 1,231 stations to date. My New Year's resolution: I will subscribe to SHORT WAVE CRAFT!

(We doff our hats and bow to the ground, Elmer! You seem to have won "first place" when it comes to running up a high score on short wave station "logs." You surely have established an enviable reputation for bringing in the "DX" (distant) stations on a short-wave converter. We have always entertained the belief that a good short-wave converter could step out and roll 'em in but we certainly are flabbergasted at your remarkable list of 1,231 stations! Again, we "wave" our hats.—Editor.)

## REVAMPED DOERLE

Editor, SHORT WAVE CRAFT:

My set is a "revamped" edition of the

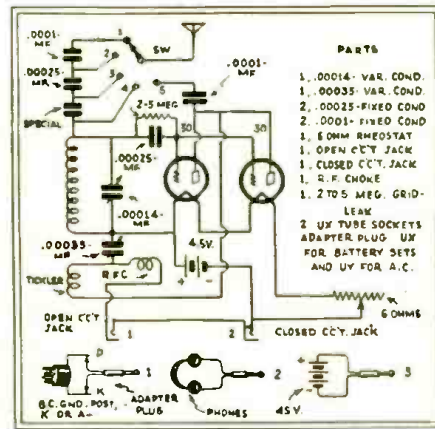

## WHOLE WORLD ON "MEGADYNE"!

Editor, SHORT WAVE CRAFT:

Congratulations, Mr. Gernsback, on your "Short Wave Megadyne." It certainly pulls in the stations for a one-tuber and loud at that! On the "broadcast" coil the Buffalo stations come in on the loud-speaker, although I haven't much of an aerial.

Here are a list of some of the amateur phone stations I received on the 75 meter band.

W1BIC, W1BNR, W1RTZ, W1AHN, W1ABY, W1BTJ, W1CBX, W2GO, W2CGY, W2DKA, W2BNZ, W2BO, W2LL, W2AWR, W2AZ, W2CZC, W2COJ, W3AB, W3BRO, W3AQ, W3BLZ, W3AQR, W3ZX, W3BRX, W3DRO, W3ALZ, W3UB, W3AQR, W1QZ, W5AW, W8AG, W8CXH, W8EDE, W8EGE, W8HXB, W8LX, W8CW, W8CUT, W8BW, W8XY, W8DK, W8CI, W8CHG, W8RN, W8LN, W8WI, W8ALZ, W8ELF, W9EER, W9GXI, W9AAI, W9GYX, W9EVC, W9FRU.

I also receive numerous commercial and amateur code stations.

Here is a list of commercial phone stations. American Airways—W8XK, W3XAL, W9XAA. Police Radio Stations—WPDQ, WRDH, WPEA, WPEE, WPEF, WPEG, WPFM, WPDF, WMDZ, WMJ, WPEK, WPDN, WPDH, WPDG, WPDJ, WKDU, KGPC.

With best 73.

DONALD BAUTZ,  
306 Berkshire Ave.,  
Buffalo, New York

(Well, Donald, you certainly pulled in a fine flock of short-wave stations on the Short Wave Megadyne. We have had quite a few reports from builders and operators of the S-W Megadyne, who have heard European and other foreign stations. The Megadyne, in our estimation, possesses a number of interesting technical features which it will pay the ham and short wave experimenter to look into and develop. Thanks again for your interesting letter.—Editor.)

"Doerle" set. I have made it as universal as possible, so that it can be used either as an adapter or a portable S.W. set, and it can also be easily connected to an audio amplifier with little trouble. The set is truly a "depression" model and can easily be built of "junk-box" material. It is very flexible as well as stable and at the same time sensitive.

Herewith is the circuit:

The parts used are 1—00014 MF. var. condenser; 1—00035 MF. var. condenser; 2—00025 MF. fixed condenser; 2—0001 MF. fixed condenser; 1—6 ohm rheostat; 1—open circuit jack; 1—closed circuit jack; 1—R.F. choke; 1—2 to 5 meg. grid-leak; 2 UX tube sockets; 1—Adapter plug.

It will be seen that a push-pull detector has been installed, simply by paralleling the elements of the original detector with those of another tube. (The filaments are in series so that a compact 4½ volt "C" battery can be used).

Also the aerial system has been changed. The "special" condenser is the one in the "Doerle" set. The condensers in series are to suit the various bands. They also aid in adjusting oscillation. It will be noticed that No. 5 is connected to the detector plates through a .0001 mf. condenser. An increase in volume will be noted when using this, especially on 75 meter ham fone.

The jack system makes for extreme flexibility. To use as a one tube set place plug 2 in jack 1 and plug 3 in jack 2.

To use as an adapter place plug 1 in jack 1.

The coils may be wound as specified for the "Doerle" set and for broadcasting a coil of 160 turns grid and 80 turns tickler will do nicely.

About results: I have tried this set on five or six different broadcast sets as an adapter and it has been more than satisfactory. Last night (or rather this morning) at 3 a. m., after all locals had signed off, we couldn't get any music on a 6-tube A.C. set so we plugged in the adapter and immediately got WBT Charlestown, N. C., louder than the locals on the 6-tube. Hi! As for S.W.'s, police, airplane, hams, S.W. broadcast and telephone—all came pounding in like B.C. signals on a good night. I have had nine foreign countries on the loud speaker using 01A's as A.F.

Would like to hear from all who build this set and will write back to all who write me—if given sufficient time. Hi!

73's

MAURICE KRAAY,  
RR. No. 1,  
Hammond, Ind.

(Thanks very much, Maurice, for your interesting and instructive letter explaining how you improved the "Doerle" receiver. We think the jack system you suggest is a very good one, and one which can very profitably be extended in the design and operation of short wave sets, whether transmitters or receivers.—Editor.)

## HONORS FOR MR. INGRAM'S SET

Editor, SHORT WAVE CRAFT:

Well, old boy, I just built Mr. Ingram's first-prize winner. Boy! She certainly can "perk." I have left off the untuned R.F. but I am using 27 tubes in push-pull.

I have covered the nine "ham" districts on 80 meters. I also receive hams on 20 and 160 meters. My set is all O.K., no "dead-spots" at all. I am using a filament transformer and one "B" battery. I have received these foreigners: I2RO, G5SW, FYA, IAC, YV11BMO, GBS, YVQ, PRBA, EAQ, YVBC, and more foreign stations.

JOEY CASALETT,  
405 Park Street,  
Utica, New York.

(Fine business, Joey, and we are sure that Mr. Ingram will be "ticked pink" to hear that you built a duplicate of his prize-winning set and had such fine success with it. We would strongly suggest that you add an untuned R.F. stage though.—Editor.)



# SHORT WAVE QUESTION BOX

Edited by R. WILLIAM TANNER

## WANTS TO ADD C.W. OSCILLATOR

V. L. Rosso, Plaquemine, La.  
 (Q) Can you furnish a circuit of an oscillator for use with a Lincoln superhet, so I can receive C. W.?  
 (A) The circuit is given in these columns. The tuned coil will depend upon the I.F. amplifier tuning.

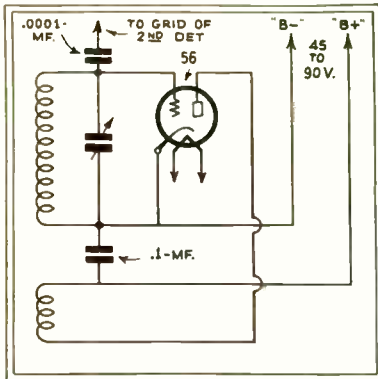

Diagram showing circuit of an oscillator for use with a Lincoln superhet, so as to permit the reception of "CW" signals.

## COIL DATA

Ed. Drury, Dupue, Ill., inquires:  
 (Q) Can you give me coil data for a Pilot Super-Wasp that will reach down to 10 meters?  
 (A) For the grid coil of the detector stage, wind (assuming Pilot form) 3 turns of wire, any size from No. 30 to 24, and space turns the diameter of the wire. The tickler coil will also have 3 turns, close-wound, placed close to the low potential end of the grid coil, approximately  $\frac{1}{8}$ ". As a tuned R. F. stage is practically worthless on such short waves, merely plug in any of the coils used for tuning and set the tuning condenser at minimum. The R. F. stage is then an untuned coupling stage.

## COIL AND CONDENSER DATA

Olivier Devers, Trotwood, Ohio, wants to know:  
 (Q) Can you give me the coil data for the circuit at the bottom of page 167 of the July issue?  
 (A) No data were given with this circuit; however, with  $1\frac{1}{2}$ " forms wind 5, 11, 20 and 45 for the 20, 40, 80 and 160 meter bands, respectively. Use No. 24 wire on all coils and space the turns on the three smaller ones. The ticklers L2 should have 5, 7, 10 and 16 turns for the 20, 40, 80 and 160 meter bands. Use No. 30 wire for these and space the tickler from the secondary about  $\frac{1}{8}$ ".

(Q) What are the values for all condensers?  
 (A) The antenna condenser .000025 mf. Tuning condenser .00014 mf. with an .00005 mf. trimmer will do OK. Grid condenser .0001 mf. Bypass condenser across the regeneration control 1 mf. Plate bypass .0005 mf. (variable condenser here is needless).

## VALUE OF C. T. RESISTOR

H. White, Celeste, Tex., inquires:  
 (Q) What is value of C. T. filament resistor used in the transmitter on page 93, June issue, when employing a '71A in place of the tube described?  
 (A) This may be anything between 20 and 100 ohms.  
 (Q) What would be the output of a '71A transmitter?

(A) This depends upon the plate voltage, and the antenna system mainly.

## FRINGE HOWL TROUBLE

Harry Ireland, Millville, N. J., writes:  
 (Q) I have built a set with two transformer-coupled audio stages. This gives fine volume but *growls* excessively when regeneration is advanced. Is there any cure for this?  
 (A) There are a number of factors which sometimes cause this "fringe howl." The cure is to try various values of grid-leak and condenser in the detector as well as different values of plate voltage. Also shunt the secondary of the first audio transformer with a variable resistor of about 250,000 ohms. Long detector and A. F. grid and plate leads or coupling between detector and A. F. grid and plate leads will also cause this howl. Poor placing of parts is probably the greatest cause of growls and unstable operation in short-wave sets and yet there is no set rule for parts layout.

## AUTO ENGINE INTERFERENCE

C. Kettering, Topeka, Kans., asks:  
 (Q) What can I do to eliminate interference from cars passing in the street?  
 (A) The first thing to do is consult the article on page 212 of the August 1932 issue and then completely shield your receiver.

## CHOICE OF TUBES

J. A. Wood, Norristown, Pa., asks:  
 (Q) In the circuit on page 286 of the September issue, the circuit specifies a 35 as R. F. and a 35 as detector. The description states a 35 as R. F. and a 35 or 24 as detector. Which is correct?  
 (A) The description states that a '35 or '24 can be used as a detector and this is correct. Use either one you want.  
 (Q) Could Pilot coils be used in this circuit?  
 (A) Most certainly. They are as good as any.

## REDUCING CAPACITY OF CONDENSERS

G. A. Smith, Lansing, Mich.  
 (Q) How can a .0005 mf. condenser be changed to .00015 mf.?  
 (A) By inserting an .00025 mf. condenser in series; the effective capacity will then be .00016 mf.  
 (Q) Is a 30 tube more efficient than a 01A?  
 (A) Not at all.

## VALUE OF R. F. CHOKE

Gilbert Cook, Washington, D. C.  
 (Q) What is the value of RFC in the set on page 400 of the November 1932 issue?  
 (A) Anything from 20 to 85 mh. is OK.

## HEAD PHONES WITH 57 DETECTOR

J. B. Mathews, Phoenix, Ariz.  
 (Q) How can I use headphones with a 57 detector and no audio?  
 (A) If you can find an audio transformer with a 500 henry secondary, use the secondary in the plate circuit and the primary for the phones.

## CHOKE VALUES

Melvin Benbrook, Maplewood, N. J.  
 (Q) Can an 85 mh. choke be used in place of an 80 mh.?  
 (A) Yes, why not?  
 (Q) What is value of filament resistor to use with a 47 tube?  
 (A) 40 ohms, center-tapped.

## AUTOMATIC VOLUME CONTROL

E. Palmer, Williston Park, L. I.  
 (Q) Can I add automatic volume con-

trol to a Pilot Dragon without using another tube?

(A) Only by changing to a diode second detector, the result being a considerable loss in volume. DO NOT try to modify a manufactured set.

## TUNING METER

B. E. Pendleton, Newark, N. J.  
 (Q) I have built a short-wave superhet

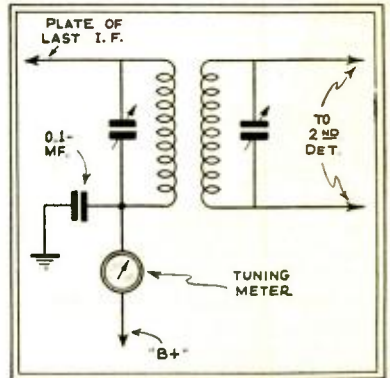

Diagram showing how to connect "tuning meter" in the "B" positive lead to the last I.F. stage.

with a 55 tube as second detector and A.V.C. How can I add a meter for tuning?  
 (A) The meter would be placed in the "B" positive lead to the last I.F. tube. This is shown in the circuit given in these columns.

## FILTER CHOKE INQUIRY

Albert LePage, Fall River, Mass.  
 (Q) In the power pack on page 487 of the December, 1932, issue, what are the values of the filter chokes and the voltage of the condensers?  
 (A) 30 henry, 60 to 100 ma. and 500 volts respectively.

## REGENERATION CONTROL

N. Simpson, Washington, D. C.  
 (Q) Can the receiver on page 272, September, 1932, issue be changed to resistance regeneration control?  
 (A) Use a 50,000 ohm potentiometer connected from 75-90 volts to B negative with the slider connected to screen grid.

## TRANSMITTER INDUCTANCE

Howard Jones, Spokane, Wash.  
 (Q) How many turns for a 40 meter transmitter oscillator tank circuit?  
 (A) Generally 5 turns of No. 4 solid copper wire or  $\frac{1}{4}$ " copper tubing 3" diameter.

## S. W. SUPERHETERODYNE

E. E. Mayotte, Ft. Wayne, Ind.  
 (Q) I want to build a short wave superhet with the smallest number of tubes possible and still obtain reasonable sensitivity. What tube arrangement would be OK?  
 (A) The following combination would give a degree of sensitivity almost equal to two I.F. stages, providing the work is well done and used with good parts and tubes. A 57 regenerative 1st detector, 56 oscillator, 58 450 kc. I.F. stage, 57 biased 2nd detector and a 47 A.F. The sensitivity and selectivity will be far in excess of any T.R.F. set having two R.F. stages.  
 (Q) Why does a T.R.F. and regenerative detector circuit result in a better signal-noise ratio?  
 (A) This is due to the very low R.F. gain of such sets.

# The New Daventry Station

(Continued from page 714)

sulated box, the interior of which is kept at a set or predetermined temperature by means of an electric heater controlled by a thermostat. The fourth cubicle of the transmitter contains the final amplifier or output stage, which consists of four 15 k.w. water-cooled tubes, connected in push-pull, the output circuits of which are coupled to the aerial feeder. The circuits of the power amplifier stages in the transmitter are of the balanced-bridge type. In some cases, the wavelength of a certain transmitter is changed by means of taps on the coils and in other cases the coils themselves are changed. By means of suitable switching gear, any one of the powerful short wave transmitters can be connected to any one of the large number of aerial systems.

## Power Supply

Power is supplied to the station by the Northampton Electric Light and Power Company, from their Power Station at Northampton, approximately twelve miles from Daventry. There is a sub-station on the Daventry site which is fed from an 11,000-volt 50-cycle 3-phase power line. This is connected to the station mains by a 300 K.V.A. transformer.

The high-tension D.C. power supply for the first power-amplifier and main power-amplifier is derived from a six-phase rectifier, having a D.C. output of 10,000 volts 6 amperes. The rectifier valves, which are of the water-cooled, thermionic type, are placed with their associated inter-phase reactors, transformers, and induction regulators; the last named are used to control the output voltage of the rectifiers and are operated by motors controlled by push buttons. A separate rectifier is provided for each transmitter equipment.

All other power supplies for the transmitters are provided by motor-generators which are housed in the motor-generator room. There are twelve of these machines, which are divided into three groups, two of the three groups being used at any one

time to supply the respective transmitters to which they are switched, while the third group of machines acts as standby plant. Each group contains four machines:—

The first is used to supply the grid-bias voltage for all valves in the transmitter and provides power for operating certain interlock relays associated with the transmitters.

The second consists of two generators coupled to one motor, the first generator having two windings and two commutators on one armature, the windings having outputs of 1,000 volts 2 amperes, and 1,500 volts 0.5 ampere respectively. This machine supplies the plate voltages to the circuits of the modulator-oscillator unit. The second generator of this combination supplies the filament current for the valves in this unit, and has an output of 18 volts 80 amperes.

The third set consists also of two generators, driven by one motor, the first generator having an output of 5,000 volts 1.5 amperes, which supplies the plates H.T. to the intermediate amplifier; while the second generator supplies the filament current for this unit, the output of which is 18 volts 80 amperes.

The fourth set is used to supply the filament-heating current of the main power-amplifiers, which consume 400 amps. at 26 volts.

The outputs of these generators are taken to a cubicle-type switchboard, also situated in the motor-generator room, on which are mounted selector switches by means of which the output of any one of the three sets of motor generators can be connected to either transmitter. All the generators described are driven by squirrel-cage type, three-phase, induction motors, which derive their supply from the station mains at 415 volts, 50 cycles, three-phase.

The power for the master oscillators is taken from a 220 volt A.C. supply provided by a 15 K.V.A. single phase transformer, which also supplies current for lighting purposes, and other auxiliary services. As the circuits of transmitters of the type

used in the Station are fairly sensitive to changes in voltage, automatic induction-regulators have been installed to compensate for variations in the voltage of the supply mains.

## Tube Cooling

The water used to conduct the heat from the plate of the water-cooled valves is re-cooled by air-blast type coolers, which consist of large radiators on one side of which are mounted fans driven by three-phase induction motors.

The water from the valve jackets flows through these radiators, and is then lifted by electrically driven centrifugal pumps to a tank situated in the roof, whence it flows again to the valve water-jackets. To prevent the deposit of scale on the plates of the tubes, which would occur if water from the local supply were used, the tube cooling system is filled with distilled water. An electrically heated distilling plant is provided to make up any loss due to evaporation in the main system.

## Aerials

It has already been explained in previous issues of *World-Radio*, that in addition to using a number of different wavelengths, the Empire has been split up into zones. There are five different groups of directional aerials, corresponding to the five transmission zones, the number of separate aerials being twelve which, with the six omni-directional aerials, makes a total of eighteen. Each aerial is connected to the aerial changing panels, already mentioned, by means of feeder lines. The aerials intended to serve Canada, West Africa, South Africa, and India, are all directional aerials arranged to radiate a beam in the direction of the particular part of the Empire for which the service is intended, following the great circle route. The aerial system for Australia has been so designed that the aerial itself and the reflector are interchangeable, thus enabling the beam to be radiated in either an easterly or westerly direction.

# When To Listen In

By ROBERT HERTZBERG

## International Call Letters

We are constantly receiving requests from listeners to identify short wave stations. As there are actually thousands of short wave telegraph transmitters on the air, this is quite a job. We are publishing herewith a list showing the distribution of call signals among nations of the world. This was adopted by the International Radiotelegraph Convention held in Washington, D. C. during 1927. Please cut out this list and paste it inside your receiver cabinet for quick reference.

Call signal	Country
CAA-CEZ	Chile.
CFA-CKZ	Canada.
CLA-CMZ	Cuba.
CNA-CNZ	Morocco.
CPA-CPZ	Bolivia.
CQA-CQZ	Portuguese colonies.
CRA-CRZ	
CSA-CUZ	Portugal.
CVA-CVZ	Roumania.
CWA-CXZ	Uruguay.
CZA-CZZ	Monaco.
D	Germany
EAA-EHZ	Spain.
EIA-EIZ	Irish Free State.
ELA-ELZ	Liberia.
ESA-ESZ	Estonia.
ETA-ETZ	Ethiopia.
F	France and colonies and protectorates.
G	Great Britain.
HAA-HAZ	Hungary.
HBA-HBZ	Switzerland.
HCA-HCZ	Ecuador.
HHA-HHZ	Haiti.
HIA-HIZ	Dominican Republic.
HJA-HKZ	Colombia.

HRA-HRZ	Honduras.
HSA-HSZ	Siam.
HVA-HVZ	Vatican City.
I	Italy and colonies.
J	Japan.
K	United States of America.
LAA-LNZ	Norway.
LOA-LVZ	Argentina.
LZA-LZZ	Bulgaria.
M	Great Britain.
N	United States of America.
OAA-OBZ	Peru.
OCA-OCZ	Finland.
OFA-OFZ	
OHA-OHZ	
OKA-OKZ	
ONA-OTZ	
OQA-OZZ	
PAA-PIZ	
PJA-PIZ	
PKA-POZ	
PPA-PYZ	
PZA-PZZ	
Q	Czechoslovakia.
RAA-RQZ	Belgium and colonies.
RVA-RVZ	Denmark.
RXA-RXZ	Netherlands.
RYA-RYZ	Curacao.
SAA-SMZ	Dutch East Indies.
SPA-SRZ	Brazil.
STA-STZ	Surinam (Dutch Guiana).
SUA-SUZ	(Abbreviations.)
SVA-SZZ	Union of Soviet Socialist Republics (U. S. S. R.)
TAA-TCZ	Persia.
TFA-TFZ	Republic of Panama.
TGA-TGZ	Lithuania.
TIA-TIZ	Sweden.
TSA-TSZ	Poland.
UHA-UHZ	Egypt.
UIA-UKZ	Greece.
ULA-ULZ	Turkey.
	Iceland.
	Sweden.
	Poland.
	Egypt.
	Greece.
	Turkey.
	Iceland.
	Guatemala.
	Costa Rica.
	Territory of the Saar.
	Hedjaz.
	Dutch East Indies.
	Luxemburg.

UNA-UNZ	Kingdom of Serbs, Croats and Slovenes (Yugoslavia).
UOA-UOZ	Austria.
UWA-UZZ	Canada.
VAA-VGZ	Australia.
VHA-VMZ	Newfoundland.
VOA-VOZ	British colonies and protectorates.
VPA-VSZ	British India.
VTA-VWZ	United States of America.
W	Mexico.
XAA-XFZ	China.
XGA-XUZ	Afghanistan.
YAA-YAZ	New Hebrides.
YHA-YHZ	Iraq.
YIA-YIZ	Latvia.
YLA-YLZ	Free City of Danzig.
YMA-YMZ	Nicaragua.
YNA-YNZ	Republic of El Salvador.
YSA-YSZ	Venezuela.
YVA-YVZ	Albania.
ZAA-ZAZ	British colonies and protectorates.
ZBA-ZHZ	New Zealand
ZKA-AMZ	Paraguay.
ZPA-ZPZ	Union of South Africa.
ZSA-ZUZ	

<sup>1</sup>Provisionally.

The call signals assigned to the United States are all 3, 4, and 5 letter combinations, beginning with the letters K, N, and W. Call signals of three letters allocated to the United States are reserved for stations open to international public and limited commercial service. All 5-letter combinations are allocated for assignment to aircraft stations.

During the World War, the groups of three letters beginning with K, N, and W were exhausted, and it was necessary to assign groups of four letters beginning with K, N, and W.

## Radio on the Ultra Short Waves

(Continued from page 712)

Having ascertained the mechanism of working the new circuit, it was then possible to investigate if it could readily be used for the production of shorter wavelengths, say of the order of 40, 30 or 20 centimetres.

The first thing observed was that by varying proportionally all the dimensions of the external circuits and readjusting the electrical supplies, the standard tubes were capable of generating at practically constant efficiency all wavelengths with a perfect continuous range from 80 cm. to 50 cm.

Considering the type of multi-unit transmitter developed we decided to adopt, at least for the time being, the ordinary well-known cylindrical parabolic reflector.

However, the high efficiency observed by experimenting with these very short waves with free end reflector rods, in place of wires or rods supported at each end by insulators, leads to a peculiar type of construction where each reflector rod is supported at its middle point by a copper tube bent into a true parabolic curve.

### Herring-bone Reflector

Fig. 4 conveys a good idea of this kind of herring-bone reflector construction and the manner in which these units can be mounted side by side to build up a multiple unit reflector.

The aperture of the reflector was fixed to three wavelengths, because we knew from experience that with this type of reflector very little was to be gained by exceeding this figure.

The focal length of the reflector has been made equal to a quarter of the wavelength used.

The distance between the reflector rods has been determined by the desirability of placing the unit transmitter and the unit reflector at a distance securing the maximum directive effect without producing unduly large and detrimental side beams. This critical distance is three-quarters of a wavelength.

The fixing of this distance by the above considerations, and the necessity of preventing the reflector and rods from touching one another, determined the maximum length of the reflector rods and consequently their spacing distance, since these two factors are interdependent.

The first short-distance receiving tests carried out indicated that—as in the case of the transmitter—electron oscillator receiving circuits based on a plate-grid Lecher wire principle were inadequate.

It was clearly indicated that the successful newly-developed transmitting tubes were very inefficient when used in the receiver, thus rather upsetting the more or less generally accepted idea that with the Barkhausen oscillating circuits the same tubes were suitable for both purposes.

In contrast with what was observed in the case of the transmitter, it was found that the plates of the tubes were the active electrodes, and should therefore be connected to the aerial instead of the grids.

Further, it was made clear that tuning was best secured by varying grid, filament, and plate potentials more or less simultaneously, and that no design would be useful commercially unless all circuits were provided with current-measuring instruments.

### New Receiver

In view of the results obtained, the plate-grid Lecher wire circuit was therefore definitely discarded, and a receiver was constructed on the same lines as the new transmitting circuit, comprising plate, grid, and inside and outside filament tuning.

The results obtained with this new receiver were most satisfactory. It was not at first appreciated, however, that too tight a coupling existed between the plate and the grid circuit, and that therefore the

(Continued on page 765)

## NEWS FROM SHORT-WAVE HEADQUARTERS

# PARTS AND RECEIVERS FOR SHORT WAVE WORK



**SW-58 THRILL BOX**

National's famous short-wave broadcast receiver. Maximum performance per dollar of any short-wave set available.

In the lead with new and better tubes and new and better circuit design. Utmost sensitivity, highest signal-to-noise ratio, unequalled flexibility, single control with full vision dial—push-pull output with 245 tubes for loud speaker reception, DC or full AC with National special SW power supply for humless operation, R. C. A. Licensed

### "AGS"

National's finest communication type commercial receiver, developed for Air-ways Division, U. S. Department of Commerce. Nine tubes. Covers frequency range 1.500—20,000 kc. Band spread coils available for 20, 40, 80 and 160 meter amateur bands. Front-of-panel coil change, extremely rigid rack panel construction, single control SFL tuning, calibration curves and tuning log on front panel, operated from AC with special National power unit, R.C.A. Licensed.



### NATIONAL ISOLANTITE SOCKET



Isolantite tube and coil sockets, glazed upper surface, give maximum efficiency in ultra high frequency circuits, suitable for sub-panel or base-board mounting, in standard 4, 5 and 6-prong types—now also available in 7-prong type.

### TYPE 100 RADIO FREQUENCY CHOKE



Extremely low distributed capacity, four narrow sections universal wound, spaced on Isolantite form. Has stiff leads for mounting but fits in grid leak clips. 50 ohms DC res.:

dist. cap. 1 mmf.; induct. 2½ mh.; rated at 125 MA.

### NEW INTERMEDIATE FREQUENCY TRANSFORMERS

Same as used in National "AGS" Communication Type Receiver and new National FB-7 Ham-Band Receiver. Litz wound, 500 kc. Equipped with trimmer adjustment for peaking that is readily accessible from top of transformer, without removal of chassis from cabinet.



### NEW TYPE BX VELVET VERNIER DIAL, WITH VERNIER INDEX

Equipped with well-known National B-Dial Velvet-Vernier drive and variable ratio, 6-1 to 20-1.—and with new vernier index, reading accurately to 1/10th division. Permits accurate logging so necessary in short-wave work.



### SEU CONDENSER

For short-wave work only. Heavy double-spaced, rounded edge 270° plates, constant low impedance pigtail, Isolantite insulation, for single hole panel- or base-mounting. Any capacity up to 25 mmf. For ultra short-wave tuning or neutralizing in low power transmitters.



# NATIONAL PRECISION SHORT-WAVE PARTS & RECEIVERS



SEND IN COUPON TODAY

NATIONAL CO., Inc., 61 SHERMAN ST., MALDEN, MASS.

Gentlemen: Please send me your new catalogue sheets giving full description and prices of NATIONAL Short-Wave Sets and Parts.

Name .....

Address .....

SWC-4-33



*The*  
**IMPROVED**  
**COMET "PRO"**  
**HAS THIS**  
**TRANSFORMER**

*The new Hammarlund Air-Tuned I. F. Transformers are available for replacement in former COMET models—or for markedly improving other superheterodynes.*

**Mail Coupon**  
**for Complete**  
**Description**

HAMMARLUND MANUFACTURING CO.,  
424-438 W. 33rd St., New York, N. Y.

Please send folder giving detailed description of the new Hammarlund AIR-TUNED I. F. Transformer.

Name .....

Address .....

SW-4

*Improved*  
**COMET "PRO"**

The Only Professional  
SHORT-WAVE RECEIVER  
With Air-Dielectric I.F.  
Tuning Condensers..



**N**OW—single signal characteristics on C.W., plus even greater sensitivity and selectivity on phone—with *easy tuning* for which the COMET "PRO" is famous.

Increased selectivity and sensitivity are gained in two ways. *First:* The I.F. transformers are tuned by *AIR-DIELECTRIC, Isolantite-insulated condensers* which hold their peak setting *CONSTANT* regardless of temperature or atmospheric conditions. They take the "if" out of the I.F. amplifier by insuring stability never possible before.

*Second:* The Improved "PRO" has a beat-frequency oscillator, with knob control, which permits varying the beat frequency over a small range, so that an interfering signal is lowered on the tuning curve while the desired signal is held full-strength at the peak.

Professional and amateur operators throughout the world hail the "PRO" superiority. Now, with these *exclusive* improvements, the "PRO" again steps out ahead of even its original leadership.



**A Good 250 Volt Power Supply**

*(Continued from page 728)*

can be filled with two small wedges of wood or cardboard covered with tape. If desired, wire may be soldered to the chassis on either side of them, to prevent them from jarring loose, in case of very rough treatment.

The resistor is supported on one end by a small angle bracket fastened to the 250 volt-binding post, and on the other end by bus-bar wiring. This proves sufficient for a good solid job and leaves no chance for a short circuit to the mountings. The leads to the variable taps should be of flexible wire long enough to reach to any desired point on the resistor.

The 110 volt supply is connected with ordinary lamp cord. In order to hold the cord to the chassis it is passed through an ordinary wire staple soldered to the edge of the hole at the opposite end of the chassis from the panel. This feature is visible in the photograph of the bottom. The cord is wrapped with tape where it passes through the staple, so as to make it tight and prevent wear.

The assembly and wiring details are apparent from the photographs of the power supply. The wiring diagram is shown in Fig. 5.

This device has served me very well. In some cases it has been used as an emergency power supply for a small transmitter. You may already have some of the parts needed. If you do not have them, the identical parts used may be purchased from the Wholesale Radio Service Company in New York City. Their catalogue number is listed with each item in the following bill of material:

**List of Material:**

1 Chassis (bent as shown in Fig. 2; 20 gauge galvanized iron) .....	\$ .30
6 Binding Posts (Eby "Ace" W.R.S. Co. No. M13027) at 5c ea. ....	.30
Hardware—13 screws and nuts—1 angle bracket—4 ft. hook up wire—lamp cord and attachment cap—bakelite strip (panel) .....	.25
1 Transformer (Trutest) Pri. 110 volt, 60 cycle; Sec. (1) 700 V.C.T. 50 ma.; (2) 5 volts, 2 AMPS.; (3) 2.5 V.C.T. 5 AMPS. (W.R.S. Co. No. 4C1494) ..	1.25
1 Choke (Crosley) Double 30 henry, 80 ma. 150 ohms D.C. (W.R.S. Co. No. 4C1494) .....	.59
2 8mf. 500 V. Cardboard type dry electrolytic condensers (Trutest—W.R.S. Co. No. D3348) .....	.86
1 2 mf. 500 V. Cartridge type dry electrolytic condenser (Trutest—W.R.S. Co. No. 2D3292) .....	.33
2-0.002 mf. Mica condensers (Sangamo "Illini"—(W.R.S. Co. No. 4D4177) ..	.14
1 Resistor (Electrad Truvolt) 25,000 ohms 50 watts (4 taps) (W.R.S. Co. No. 4G7319) .....	.80
1 Socket (Eby wafer type—4 prong) W.R.S. Co. No. 4M13070) .....	.05
Total—(Parts for complete power supply) .....	\$4.87

**The Latest In**  
**Super-**  
**Regenerators**  
**In The Next Issue**  
**WATCH FOR IT!**

## The Oscillodyne

(Continued from page 721)

as it will be found that as soon as the natural frequency of the tickler coil becomes less than that of the tuned grid circuit, the plate load becomes capacitative and phase relations are no longer correct for oscillation.

It becomes evident, then, that as the frequency of the signals received is increased, enabling the use of smaller inductance coils, the damping constant, ( $\mathcal{E}^{2L}$ ) increases, and operations of the circuit becomes more satisfactory. Hence it will be found that this circuit is particularly well adapted to short-wave reception (which is also true of the super-regenerative circuit and for the same reason.

### How to Make the Simplest One-Tube Oscillodyne Set

In this article is described a simple one tube receiver employing the *oscillodyne* principle.

The schematic diagram for this receiver is shown in Fig. 4. The tube employed is a type 27 employing 2½ volts A.C., or a 37 using 6.3 volts D.C., on the heater and 90 volts plate potential supplied by a "B-eliminator," or battery. Other tubes such as the type 30, 56, 01A, 12A, etc., may be used if desired. The only change necessary is to supply the appropriate filament voltage for the tube selected. In general, screen grid tubes are not satisfactory in a one tube receiver due to the difficulty of matching the extremely high plate impedance of the tube to that of the earphone.

The plug-in coils employed are wound on tube bases. The specifications for the windings are given in the table accompanying this article. The turns of both windings are wound without spacing. It is essential that the two windings be wound in the same direction. This means that if the two inside terminals of the windings are connected together, the coil will appear like a continuous winding tapped near the center.

In regard to coil specifications, the following table is furnished for tube base coils wound with No. 36 D.S.C. wire and tuned with a 100 mmf. (.0001mf.) condenser. The first two coils may need a half turn adjustment one way or the other.

Approximate Wavelength (meters)	Sec.	Tickler
14-25	4	6
23-41	7	9
40-85	14	12
83-125	23	23
120-200	36	36

About ¼" separation between windings. It will obviously be necessary to extend the tube base forms if coils for the "broadcast band" are used. However, grid and plate windings of about 67 turns will tune from 200-360 meters and 105 turn windings will tune from 350-560 meters with the above condenser.

After the leads are soldered in the tube prongs, all superfluous solder should be carefully filed from the sides of the prongs to prevent damage to the coil socket when inserting. The windings should be so connected that the two outside leads go to the grid condenser and plate of the tube, respectively, while the two inner leads go to the cathode and phones respectively. If connections are not made in this manner the tube will not oscillate!

In order to provide exact coverage of the various frequency bands with suitable overlap at each end, it may be found desirable to vary the number of grid turns by a half turn or so for certain coils.

A suggested layout of parts is shown in the photographs. If other parts than the ones used are substituted it may be necessary to vary this layout somewhat. In wiring the receiver only nine leads are necessary and if these are carefully made

(Continued on page 762)

## Attention! Radio Technicians!

# A Short Wave Switch for

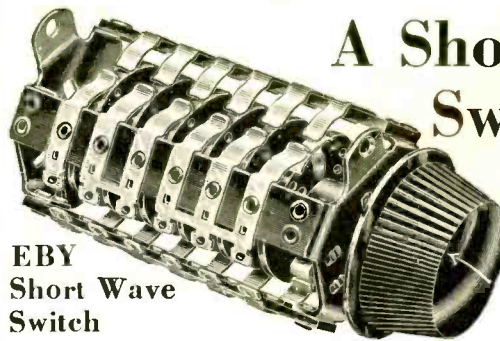

Engineers,  
Experimenters  
—All Short  
Wave Fans

### EB Y Short Wave Switch

Check these points on the EB Y Switch—they prove EB Y superiority

1. *Sturdy construction* permits ganging any number of units into a strong, compact assembly.
2. *Compactness* resulting in the switching of intricate circuits in very small space.
3. *Flexibility* providing any variety of circuit arrangements and contact sequences desired.
4. *Negligible Capacitance Effects* between adjacent switch circuits and to ground.
5. *No Variable Effects.* Compensated high frequency circuits remain satisfactorily adjusted for any position.
6. *Exceptional low Contact Resistance* is obtained by use of the best silver plated bronze contact springs. Simplified hook-up eliminates all loose or high resistance contacts.
7. *Common Ground Connection* of shaft, end plates and all electrically inactive parts.
8. *Insulation* of the highest quality between all circuits and ground.
9. *Smooth Action and Positive Alignment* are obtained thru sturdy construction and special design, featuring the ball bearing snap action giving positive, decisive switch position.
10. *Universal Mounting* with either single hole threaded bushing or two hole screw or eyelet mounting.

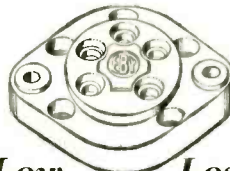

### Low Loss ISOLANTITE SOCKETS

Designed especially for Television and Short Wave sets  
The Eby Low Loss Isolantite Sockets offer the most positive and efficient socket operation possible. It will pay every experimenter and designer to rely on EB Y sockets for perfect contact. The difference in set operation is readily noticeable.

**H. H. EBY MFG. CO., INC.**  
1646 West Adams Street Los Angeles, Calif. 154 E. Erie Street Chicago, Ill.  
21st & Hunting Park Avenue Philadelphia, Pa.

### Mail this Coupon

H. H. Eby Mfg. Co., Inc.,  
21st and Hunting Park Ave., Philadelphia, Pa.

Send me complete catalog information and prices on your new Short Wave Switch and your Low Loss Isolantite Sockets.

Name .....

Address .....

## INFRA RED HEALTH LAMP

(Floor Model with flexible shaft)  
Recommended by all health institutions and physicians all over the world.

Save doctors' bills  
Save your health  
Save your family the trip to the doctor who charges \$5.00 per treatment.

List Price \$25.00  
Your Cost . . . **\$9.75**

One sale in a neighborhood sells 5 more  
Send for circular with full details.

**Gold Shield Products Co.**  
112 Chambers St. (S. W.) New York

## ACME HEADPHONES



Complete weight  
5 ounces  
4000 ohm D. C.

You need have no more headaches from using heavy ear-phones.

The Acme 4000 ohm head-set has more than 10,000 turns of wire on each coil. Your background noise is cut down. Weak stations heard more clearly. DX becomes more thrilling. Buy from your local jobber or send us his name and \$1.50 for a sample pair of phones.

**DEPT. Y, ACME SPECIALTY COMPANY**  
2000 Mendel St. Chicago, Ill.

See Announcement on Page 766 Regarding the special subscription offer  
**RADIO REVIEW AND TELEVISION NEWS**

# Short Wave Fans and Amateurs

M. & H. has been established for 35 years. During that time it has served thousands of mail order buyers. We solicit your good will and business on the guarantee of—"complete satisfaction assured."

No one complains who deals with M. & H.

HEADQUARTERS FOR ALL STANDARD PARTS  
HAMMARLUND—CARDWELL—NATIONAL THOR-  
DAHSON—AMERTRAN—KENYON, ETC.  
Complete stock on hand at all times of Weston & Jewell Meters.

### HYTRON TRANSMITTING TUBES

- UX210R—A special heavy-duty 210 tube having oversize plates with grid terminal brought out top of tube to cap like 865-type tubes. Low internal capacity and high output (15 watts), especially recommended for 5-meter transmitters. Your Cost, \$4.12
- UX210X—Same as above but with plate lead brought out through the top instead of grid lead. Will stand high voltages safely. Your Cost, \$4.12
- UX271—An intermediate mercury vapor rectifier between the 241 and the 960 tubes. 241-volt filament at 3 amps.; 5000 volts at 300 milliamperes. Your Cost, \$1.25
- UX866—A heavy-duty mercury vapor rectifier rated at 7500 volts at 600 milliamperes. 241-volt filament. Your Cost \$2.25

### Dunco Vacuum Tube Relay

Ultra-sensitive unit for D. C. in coil circuit and either D. C. or A. C. in the control circuit. This unit is specially adapted to operation in the plate circuit of small vacuum tubes. Controls rated at 2 amps. at 110 volts A. C. Size 2 7/8" long x 2 1/2" wide x 5/8" high. \$5.00 long. 1 1/2" long. \$5.00  
We carry a complete line of Time Delay and Remote Control Relays. All standard makes. Let us know your needs.  
Complete line of Delta chokes. Transformers and power transformers at very low prices.

### M. & H. De Luxe Monitor

For anyone desiring a permanent means of monitoring their transmitter carrier.  
Constructed of the highest quality materials obtainable! Coils for 20, 40 and 80 meter amateur bands. Uses two number 4 Burgess dry cells and one No. 4156 B Battery.  
Wired or kit form, with tubes and batteries, wired complete. \$14.00  
Kit Only (assembled but not wired). \$11.00.

### M. & H. Electron Coupled Frequency Meter

This new meter is an outstanding development of the year. Housed in one-piece cast aluminum box, with heavy aluminum front panel, suitably engraved.  
Uses one type 24 tube, two 45 volts, portable-type. Completely calibrated with all batteries and tube—\$29.50.

### Chase Quality Quartz Crystals

Each crystal is individually calibrated. Guaranteed accurate under conditions specified in calibration sheet.  
Supplied complete with new Chase holder with its frequency and temperature markings on a separate card.  
1715 to 2000 K. C.—Holders included..... \$ 8.00  
35 to 4000 K. C.—Holders included..... 8.00  
7000 to 7300 K. C.—Holders included..... 12.00  
500 to 600 K. C.—Airgap Holder..... 9.00  
Chase Crystal Holders only..... 2.50

### For a limited time only we offer special bargains on READRITE PANEL METERS OF ALL KINDS

- D. C. VOLTMETERS**
- From 0.1 Volts 30 Ohms to 0.25 Volts 1625 Ohms at 59c each.
- No. 604—0.25 Volts 7720 Ohms..... \$1.47
- No. 337—H. C. 50 Volts..... 1.77
- No. 239—0.100 Volts 6500 Ohms..... .74
- No. 339—H. C. 100 Volts 2800 Ohms..... .74
- No. 609—0.750 Volts 231600 Ohms..... 2.94
- D. C. AMMETERS**
- From 0.1 amperes to 20.0—20 amperes..... 59c each.
- D. C. MILLIAMMETERS**
- From 59c to \$1.18 all types in stock.
- A. C. VOLTMETERS**
- 0.4-0.6 Volts—0.10 Volts—0.15 Volts..... \$1.47 each.
- 0.150 Volts \$2.36, 0.300 Volts..... \$2.94
- 0.750 Volts special at..... 3.53
- 0.600 Volts..... 3.53
- A. C. AMMETERS**
- From 0.1 Amps. to 0.10 Amps. \$1.47 each. 0.50 Amps. \$1.77
- A. C. MILLIAMMETERS**
- From 0.25 Milliamps to 0.500 Milliamps..... \$1.47 each.

### As Specified in many of Short Wave Craft Articles

Oscilloscopes: Set of four, with wave length range from 15 to 200 Meters. The most rugged Short Wave coils ever designed in four distinctive colors—complete set of four..... \$4.95  
Broadcast coil, range 200-520 Meters, special 75c each.

M. & H. Telegraph Key, 1 1/2" contacts will handle M K. W. easily. Of highest quality. Special 95c.  
Wireless Practice Set. Just the thing to master the code with. Comes with booklet on how to learn the code and full instructions on how to use instrument. Equipped with high frequency Radio buzzer. Special \$1.98.  
We have what you have been looking for in Keys. Write us.

Electrology Chassis Bases. Very handy for mounting all Radio Instruments and the three sizes make it possible to mount any type receiver. The height of each size is 3 inches which is standard for all type receivers and power packs.  
No. 1515—10" x 12" x 3"..... \$1.61  
No. 1516—10" x 23" x 3"..... 2.74  
No. 1517—10" x 17" x 3"..... 2.20

A Popular Shield Can—Measures 4 1/2 x 3 3/8 inches, length 4 1/2 inches. For use in making condenser blocks or transformers.  
We maintain a completely equipped machine shop to give prompt attention to your special order work, on the cutting of panels, etc. Send complete drawings and specifications for quotations on this type work.

Short-Wave Plug-In Coils—Suitable for receiver or transmitters up to 30 Watts. Six contacts, 4 1/8" long, 2 1/2" diameter. Coil forms only, 84c. Base only, 84c.

Original Martin Vibroplex—The new improved model, a handsome and efficient.  
Furnished in red, green, blue or black.  
Your cost \$16.50  
Push lined carrying case for Vibroplex Key. \$2.94

WESTON METERS TYPE 301—0 to 100 M. A.  
Newly rugged model in perfect condition.  
Regular Price \$8.00. While they last Special \$3.00 each

### CASED FILAMENT TRANSFORMER

- 2 1/2 Volts C. T.—10 Amps..... \$1.25
- Microphone Transformers. High quality—Low prices.
- Type CM—200 single button..... \$1.75
- Type CM—400 double button..... 2.25

FREE CATALOG SENT UPON REQUEST CONTAINS EVERYTHING

# M. & H. SPORTING GOODS CO.

512 MARKET STREET PHILADELPHIA

NOTE:—Above prices include Govt. Tax. Mail orders filled same day—10% cash must accompany all C. O. D. orders.

# How I Learned to Handle Code

(Continued from page 719)

decipher the unevenly spaced transmission of the self-taught "ham." It is plain to him, no doubt, but to me his sending is comparable to a Chinese puzzle. I do not wish to deprecate all amateurs; some of them send beautiful code which it is a pleasure to copy. Some of our most efficient radio operators are amateurs.

### Coordination

Until the student learns to coordinate he cannot hope to learn to send rapidly or accurately, no matter how much he indulges in so-called "practice," and it follows logically that his inability to transmit accurately retards his receiving progress. There can be no speed without coordination; trying to speed up without it is like a child trying to run, before having learned how to walk. Herein lies the big stumbling block of the self-taught student. When he goes on the air—and believe me, far too many are on the air—he sends like the following:

"6 - is - - - isa - - setmanle - - - -  
tm - - it - - - hi - s - - - - s - etc - ti  
- ite - tm."

After the excitement subsides, the confused fellow who has been writing down this jumbled hodgepodge slowly and painfully decodes it thus:

"This is a sample of his sending."  
If you believe I exaggerate, listen in on any of the amateur bands and judge for yourself.

The Candler Code Guild, an organization of Candler System graduates who broadcast regular practice programs, is accomplishing a great deal of good in this connection by sending out properly spaced practice material.

Before the student begins the study of code, Candler shows him how to study and practice. This mode of procedure is necessary, for study and practice without experienced guidance are but a waste of time and energy. He tells the student that a "dit" is made as rapidly as he can make it without cramping his arm, and that a "dah" is exactly three times longer, and must always be made the same way whether the student is transmitting at five or forty-five words per minute. There are no such things as short, medium and long "dahs" or slow, medium and fast "dits." Speed is determined by spacing between signals, between words and groups—never between parts of signals.

Example:  
(At 5 wpm) s-----e-----n-----d  
(At 10 wpm) s-----e-----n-----d  
(At 15 wpm) s-----e-----n-----d  
(At 20 wpm) s-e-e-n-d

When a student has followed this system of spacing from 5 words per minute, step-by-step, until he can send 20 wpm, evenly and smoothly, he has developed his "timing sense" to such a degree that he automatically spaces all his signals uniformly at varying speeds. The self-taught fellow will send one word spaced at 20 wpm., another word spaced at 10 wpm., and another word spaced at 15 wpm., and so on, which works a hardship on the one who is trying to receive his transmission.

Spacing and every phase of code technique become semi-automatic with the proper training and practice, and as the student's speed gradually increases he finds that within his limits he can read and send code without conscious effort, or as easily as he reads a book or listens to some one talk or writes, without thinking, consciously, of how words are spelled. This is the "secret," if I may so term it, of skill and speed.

### "Sound Consciousness"

It is hard to determine the most important phase in learning code, but it is my belief that in fast, accurate reception, the element of "sound consciousness" plays a necessary part. To the untrained ear, dits and dahs sound alike, and always their similarity marks the "ceiling" or

limit of a student's receiving ability; that is, if his receiving speed is 10 wpm., at 15 to 20 wpm., all dits and dahs sound alike to him. In this connection, I recall an amusing incident at the Chicago tournament where I received, at 56 1/2 wpm., material from the Congressional Record, transmitted by a Wheatstone automatic. Charles O. Stimpson, now publisher of the Radio Amateur Call Book, was chief operator, and one of his duties was to listen in and keep check on the transmission.

Believe me, that was a rather tense five minutes for all of us. After the excitement was over and my copy was in the hands of the judges, Charlie emerged from his listening booth and approached me, a puzzled expression on his face.

"Listen, kid," he whispered in my ear, "did you get it?"

"Sure," I replied, surprised at his question. "Why do you ask?"

"Well, all I could hear," he explained, "was just one endless string of dits without even so much as a space anywhere."

Stimpson's receiving speed was around 40 wpm. Listening to transmission at 56 1/2 wpm., faster than his limit, he had no "sound consciousness." All he heard was a string of dits. I give this incident to illustrate my meaning with reference to this phase.

Candler's original method of developing "sound consciousness," which treats specifically of the psychology of code reception, is, I am convinced, one of the principal reasons for the phenomenal success of his system of teaching code. Of course, I am well aware that every other phase of his method is an integral part of the system and contributes to the quick development of "sound consciousness" and aids the student in his progress, not only as a student, in overcoming the drudgery met with in learning code by ordinary methods, but as a radio operator doing fast, accurate work.

### Conclusion

When I won the championship the first time, no one was more surprised than I. My nearest competitor was José Seron, a Chilean, who held the previous record of 49 wpm. I copied 51 wpm., for 5 minutes. The following year in the New York tournament, I copied 55 wpm., and the next year at Chicago I turned out 56 1/2 wpm., and twenty minutes after this last performance, I copied American Morse Code at 70 wpm., for 5 minutes!

All this time I had been working as an American Morse operator for the Western Union in Boston, and I may add that one of my prize possessions is a letter of congratulation from Mr. Newcomb Carlton, President of the Western Union, who had never heard of me previous to my performance.

My success was due to the fact that I had been properly trained; I knew how to use my mind, how to concentrate, to coordinate my faculties, and my sound consciousness was developed to such a high degree that nothing escaped me. And now in concluding this brief account of my activities as a "ham," I want to state conscientiously that whatever success I may have achieved I owe to the thorough, scientific training of Walter Candler's methods. Under the same conditions, with the same training, any normal young man can accomplish what I did, perhaps more.

**What to Do with  
Your Old Radiola V**

**Make an  
S-W Receiver with It**

**See Next Issue**

## A South American 7-Tube All-Wave Superhet

(Continued from page 724)

The short wave coils will probably be all right as specified.

No measurements are given for the positions of the two tuning condensers, as different makes require different space and mounting holes. Lay the two condensers on the chassis and then place the modulator and oscillator tubes and the coil sockets so they are in the relative positions shown in photo. The distance between the modulator and oscillator tubes must be at least 8 inches to avoid undesirable coupling. Drill the necessary holes and mount the sockets and condensers.

Condensers C7 and C8 are fastened under the modulator and oscillator coils sockets respectively. The two flexible resistors R1 and R2 and condenser C13 are soldered together in series, with the condenser in the middle and they are soldered directly to the prongs on the tube sockets and hang free in the air away from all metal.

All wiring from the coil and tube sockets passes directly below deck except the resistors R1 and R2 and the condenser C13, as well as the leads from the oscillator coil to the tube and tuning condenser; the leads from the modulator tube and the tuning condenser and the tickler lead from the coil to the tube socket. The shielded plate lead from the modulator to the first I.F. coil goes below deck. The diagram is drawn to show which wiring is above and which is below deck. The photographs show the relative positions of the parts.

All grid and plate leads are shielded from the modulator plate up to the tickler winding on the fourth I.F. coil, but from that point on, they are unshielded. The shield of the wire must be grounded. I forgot to ground one in this set and for days I looked for the cause of the erratic results I was experiencing—one moment weak and the next loud and noisy. I knew I had a bad connection, but of course, I was looking for a connection in the actual wiring. One day I had the set on edge with a station tuned in and I was pushing and pulling all the wires trying to find the fault and every time I moved the shielded wire from the second detector to the tickler it would appear worse, so I decided that the wire in the shield covering must be broken. I snipped it off and put in another wire and then discovered that the shield was not grounded; as it was moved around it continued to make and break contact at the point where it passed through the chassis. It was a difficult job to insert the new lead as it was under all the other wiring. So don't forget to ground all the shielded leads, including the antenna lead from the coil to the binding post.

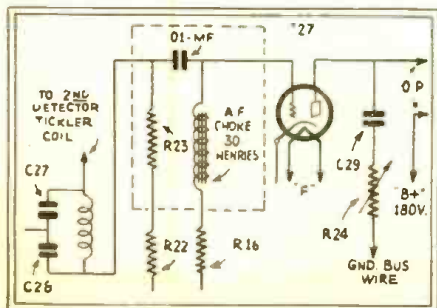

Details of coupling unit between 2nd detector and 1st A.F. tube.

# FEATURING— The Outstanding Short Wave Receiver of the Year!

Shattering all records for consistent, sensational performance,  
**THE NEW IMPROVED ROYAL OLYMPIC**  
establishes a higher standard of Short Wave reception. Verified, loud speaker reception from every continent renders a new conception of true "round the world" reliability!

### THESE FEATURES GUARANTEE REAL PROFESSIONAL PERFORMANCE

Lowest Background Noise Level  
"TRANS-X" Coupling. (An exclusive Royal feature)  
9 to 600 Meters. Amateur Band Spread.  
TWO-Speed Full Vision Dial  
Velvet Regeneration Control  
Super-control High Gain RF Stage  
using new Six Element Tubes  
Electron Coupled Circuit  
Triple Filter—Absolutely no hum!  
Completely Shielded  
Triple Grid Detection  
Power Pentode Output using  
New Heater Type Tubes  
Speaker or Phone Operation  
For 105 to 130 Volt AC



### THE ROYAL OLYMPIC

Uses 2-58, 1-56, 1-2A5, 1-280.  
Complete, ready to plug into AC Socket, with coils for 14 to 200 meters or 20, 40, and 80 Meter Amateur Band Spread. (Less tubes and speaker).  
List Price, \$50.00  
Our SPECIAL WHOLESALE PRICE..... **\$29.40**  
Royal S. W. Tested Tubes..... \$3.60

### BATTERY MODEL

Uses 2-232, 1-230, 1-233.  
Most efficient battery operated Short Wave Receiver. Powerful, yet extremely economical!  
List Price, \$35.00  
Our SPECIAL WHOLESALE PRICE..... **\$20.58**  
Complete KIT with full wiring instructions \$17.64  
Royal S. W. Tested Tubes—\$3.55  
Complete set of Large Batteries—\$3.95

Other ROYAL Models—as low as \$14.50. See March Short-Wave Craft, pg. 683, or send for literature.

## The Improved 12,500 Mile Two Tube Short Wave Receiver



The sensationally popular 12,500 MILE receiver—Improved—refined—and available in complete kits that are so easy to assemble.

Our Engineering Department incorporated new features such as velvet regeneration control with no detuning effect, ultra low loss condensers of advanced design, friction drive (no backlash) vernier dial for easy tuning, metal chassis and panel for efficient shielding, eliminating hand capacity; and other carefully selected and tested refinements, resulting in a receiver that by far outperforms the original.

These kits contain every necessary part of highest quality. All high frequency insulation is genuine Bakelite. The coils, which tune from 15 to 200 meters are wound on polished Bakelite forms. The sockets are Bakelite. All losses are minimized! The attractive crystal finished chassis and panel has all holes needed to mount the apparatus and this, together with our complete, detailed instruction sheets, simplifies construction.

Only by purchasing in large quantities are we enabled to offer these neat, professional appearing sets at such an amazingly low price! And the parts are all first grade, too! See advertisement in previous issue of SHORT WAVE CRAFT for full details of this remarkable receiver.

# \$4.45

### DC MODEL

Uses two 230 tubes. Batteries required are two dry cells (or a 2-volt storage cell) and two 45 volt B Batteries. If you have a 6-volt storage battery you may use 201-A's.  
**COMPLETE KIT . . . \$4.45**

### AC MODEL

Uses two of the new type 58 tubes. Power is obtained from the Model ED power listed below or from any good eliminator delivering 90-200 volts and 2½ volts.  
**COMPLETE KIT . . . \$4.95**

### ACCESSORIES

2½ volt Filament Transformers, 95c. Heavy Duty, \$1.35.  
RCA Licensed TUBES Fully guaranteed for three months. 230—75c. 201-A—39c. 237—45c. 56—60c. 280—45c. Other types at lowest prices.  
Large Dry Cells—29c. Large 45 volt B Batteries—77c.  
Imported light weight phones—\$1.33. Better grade, very sensitive, \$1.75.

### POWER PACK

POWER PACK—Delivers all power for AC Receiver. Heavy transformer and extra filter insure quiet reception on short waves. Plug into 110 volt, 60 cycle house line. Stamped metal chassis. Uses a 280 tube.  
**COMPLETE KIT . . . \$4.85**

We are NATIONAL DISTRIBUTORS of every advertised line and can supply your entire wants at the lowest prices. Send in your list for our quotation or just order everything you need. We will make immediate shipment of your order and guarantee our prices to be lowest! A trial will convince you!

SEND YOUR ORDER NOW OR WRITE FOR PRICES.

Prices F. O. B. New York.  
Deposit Required.

VISIT OUR SALES ROOMS.

## HARRISON RADIO CO.

★★ THE HOME OF FOUR STAR SERVICE ★★

Dept. C-18 New York City  
142 Liberty Street

# Make MORE MONEY in RADIO with R.T.A. Professional TRAINING

Home study with R.T.A.—plus lifetime membership in our large, powerful association of radio service men—brings you up to date on all improvements in radio, television, sound engineering, and keeps you among the real money-makers in this expanding field. Unless you have this high-type professional training you will find it hard to get out of the poorly paid "tinkerer" class.



### New-Type Set Analyzer Included

As part of R.T.A. training you get this up-to-the-minute Set Analyzer and Trouble Shooter. After a few easy lessons you are ready to use it for immediate money-making, competing with "old-timers" without fear. With this wonderful piece of equipment, backed by R.T.A. professional training, you need have no fear or worry over the future. Even though there should never be a new radio set constructed—or not another improvement in radio made—there are enough sets now in service that need frequent attention to assure you good money as an adept Radio-technician.

### Start Money-Making Quickly

R.T.A. Training is especially designed—and given you by one of the outstanding teachers of radio technology in the world—to get you into the profitable end of radio quickly. It is not empty theory, but practical, down-to-earth work that makes you a money-maker in this immense field in the shortest possible time. Don't delay your start toward success! Write at once for all details about R.T.A. training. The Coupon below brings FACTS—astonishing ones that may open up a new depression-proof future for you.

## MAIL COUPON NOW!

RADIO TRAINING ASS'N. OF AMERICA, 4613 Ravenswood Av., Dept. SW-4, Chicago, Ill. Send me all the FACTS about R.T.A. professional training, together with information about the opportunities existing for R.T.A. Radiotechnicians today.

NAME .....

ADDRESS .....

## Learn At Home Be A Radio Operator New Easy Way with Teleplex

### The NEW MASTER Code Teaching Machine

Trains you at home in half the time and at a fraction of the cost of other methods. No experience necessary. Opportunities for qualified radio operators. The only instrument ever produced that records and repeats your own sending. Used by U. S. Army and Navy, R. C. A., A. T. & T., and principal schools. Loaned with our Complete Code Course without additional cost. Easy terms. Get started NOW! Write for folder SW-4 giving full details.

TELEPLEX COMPANY  
76 Cortlandt St.,  
New York, N. Y.

## Electric Telegraph Set 15c BOYS!

A private Electric Telegraph Set of your own for 15c. Lots of fun sending messages to your friends. Better still, two sets, hook them up, as shown in the directions, for TWO-WAY MESSAGES (sending and receiving.) No trouble at all to operate with the simple instructions that accompany each set. Operates on any standard dry battery obtainable everywhere. With this outfit you can learn to transmit and receive messages by the Morse International Code, and in a very short time become an expert operator. Mounted on wooden base measuring 4 x 3 in., first class construction throughout, complete with key, buzzer, magnet, miniature Western Union blanks, pack-cable in neat box with full illustrated instructions—ALL FOR 15c (without battery) postpaid. (Can be ordered in U.S. and Foreign.)

Add 10c for 64 page book "BOY ELECTRICIAN". Tells how to make batteries, dynamos, motors, radios, bells, engines, etc. BIC 170 PAGE CATALOG 10c. Amazing catalog of novelties, tricks, puzzles, jokes, books, etc. 10c postpaid.

Johnson Smith & Co., Dept. 568, Racine, Wis.

### Adjusting and Operating the Set

Only one stage of audio amplification is shown and the second stage and power supply are left to the individual builder as they are all very much the same and many people will have a power unit and amplifier which they can use. The audio transformer I used was a Silver-Marshall type 255. I took out the resistor that came in it and inserted a 100,000 ohm one watt resistor in its place, and then a 100,000 ohm one watt resistor in series with it to the 180 volt supply. There are only five leads from the set—two filament leads to a 2½ volt A.C. supply; the B minus; the B plus 180 and the output to the primary of the following transformer.

The grid leaks R7, R8, R9 and R10 are very important. I am now using R7—20,000 ohms; R8—125,000; R9—125,000; and R10—1 megohm. The builder should try different values and each change will give different results. Usually the I.F. tubes will oscillate if the resistances are too high. Don't forget this point as it is very important.

With regard to the aerial, I would like to say that I have found after trying several types such as a 150 foot four-wire aerial, 50 feet high; three wires of the same dimensions; single wire of the same size and height, that changes made very little if any difference. Then I made a 44 wire horizontal loop erected in a 12 by 14 foot room two feet from the ceiling and wires spaced 4 inches; then a 50 foot vertical wire aerial; then a T-type, 200 feet long, with the lead-in soldered to the center. Each of these aeriels was tried with and without a ground. I find that for short waves, a ground makes no difference, here. After all this work trying to get the best aerial, I have decided that a long straight wire is as good as any, and that the longer it is, the stronger the signal! My present antenna is 225 feet long, of number 10 copper wire and averages 14 feet above the ground. I had it 60 feet high and lowered it to the present height without any noticeable change, so I left it there as it is much easier to clean the insulators.

My opinion of these trick aeriels of exact dimensions, after my experiments, leads me to believe that with my long low aerial I will get any station just as loud as anyone else, regardless of their pet ideas. Of course, I have never had an opportunity to try this out in any other place.

### Loud Speaker Volume on 3 Ft. Aerial!

I find that for short waves, I can switch the ground on or off and no change takes place. In fact, I never know whether the ground is on or off until I change to the longer waves and then it is quite essential. On a night when the world is coming in down here I can use a 3 or 4 foot piece of wire as an aerial and get loud speaker volume that is heard 500 feet

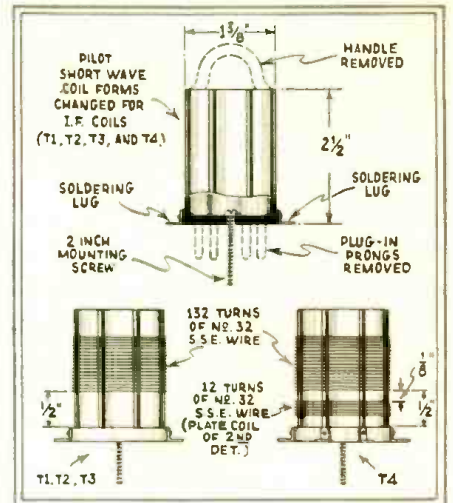

Details of Coils used in South American Super-het.

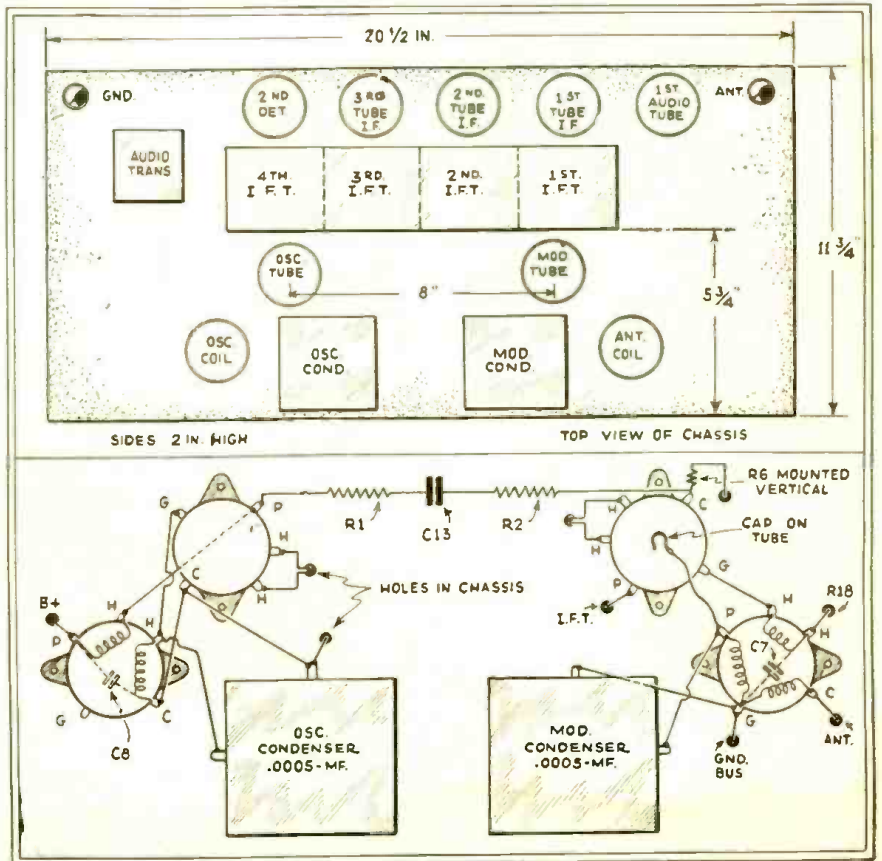

Plan layout of "I.F." stages and other parts of South American Super.



away, but for day time reception a long one is much better and for the broadcast band (200 to 550 meters) a long one is necessary.

When you remember that we are 3200 to 3800 miles from the U. S. and crossing the tropics and that reception conditions here are probably as bad as anywhere in the world, due to the static, you will understand that continuous reception of U. S. stations is no small feat.

I have a list of 42 U. S. broadcasting stations that can be received at any time! One curious thing is that the most westerly station I can get on the broadcast band is KOA in Denver or WOAI and WFAA in Texas. Never a west coast station, and as I come from the west coast, it is natural that I would like to hear one.

When the set is finished and ready to try, turn on the voltages and adjust the clips on resistors R19 and R21 to give 50 to 75 volts on the oscillator plate and 75 volts on the screen grids. Turn R20 to the point of almost least resistance and R18 to about the center of the scale. Plug in a set of coils and turn the oscillator to a point near the center of the scale and then turn the modulator condenser across the full scale. If you do not hear anything, turn C3, C4, C5, and C6 in about half way. Then adjust the oscillator and modulator again.

When you hear the first sound or signal, start adjusting the I.F. condensers C3, C4, C5, and C6 to approximately 425 kc. It is not important whether the frequency is exactly 425 or not, if the circuits are all in resonance. If the grid leaks are close to the correct size, the set will appear to be dead, but when the modulator is turned to be in step with the oscillator the signal will jump out of the silence and probably scare you half to death, especially if you hit one of the strong commercial stations. They almost wreck the speaker!

I wish to impress upon you that just because the set seems dead does not mean that it is not working correctly. Change the setting of the oscillator condenser slightly and move the modulator across the dial until you get a signal. If after getting signals, and R20 is turned to the maximum position, the I.F. amplifier oscillates, change R7 to a lower value until it is just below the oscillation point. That completes the adjustment. You are ready to get anything that is on the air!

**When to Listen**

Always remember that the 19 meter band is for daylight reception only, while the 25 meter band is more or less good for both day and night. The bands of 31 and 49 meters are only for night time, although I have heard Saigon, French Indo-China, on 49 meters from 7 to 9 a. m., E. S. T., several times. Also remember that most European stations shut down at midnight, their time, which is five hours ahead of E. S. T.

The very slowest that you can possibly turn the oscillator dial is several times too fast, for you can get as many as five stations in one division of the dial! So turn it as slowly as possible. Your first trouble will be to learn how to turn the dial slowly enough.

**List of Parts for the Baldwin All-Wave Superhet**

- 1 Chassis of copper, brass or aluminum, measuring 20.5" long, 11.75" wide, and 2" deep. Blan, the Radio Man.
- 1 aluminum, brass, or copper shield with four compartments, or four separate shield cans, as described in article and shown in illustration. Single shield shown in model measures 14" long, 3.5" wide, 5" high, inside dimensions. If separate shield cans are used (either round or square may be employed) they should measure 3.5" in diameter by 5" high. Blan.
- 4 I.F. tuned impedances 465 kc. standard I.F. transformers may be used by removing one of the coils in each unit, and placing a small coil for the tickler near the I.F. coil in unit No. T4; number of turns given in text.

**UNCLE DAVE**

**356 BROADWAY, ALBANY, N.Y.**

**WE BUY-SELL & TRADE HAM STUFF!**

**24 HOUR SERVICE - SHIP ANY PLACE**

**WE MAKE IT OUR BUSINESS TO GET WHAT YOU WANT AT LOWEST COST**

Erpee Featherweight Phones, per pair.....	\$1.95
Baldwin Phones, type "C".....	3.39
Baldwin Type "G", the old reliable.....	4.95
Baldwin Type "N", very latest thing in featherweight dynamics, per pair....	7.95
Soft rubber ear cushions, per pair.....	.50

**25-Watt Socks the ether more like a TUBE** fifty than a '10. Plate voltage 750, bias voltage—85/100, filament 7½ volts. Big husky plate with terminals at the top. New and improved internal construction; each one tested at Uncle Dave's. A real addition to any transmitter. **\$4.25**

**UNCLE DAVE'S**

**25 WATT TUBE**

**\$4.25**

AT LAST, UNCLE DAVE HAS GOT US AN IMPROVED A-CIAL TRANSMITTING TUBE WITH A D-X SOCK

Heavy duty '96s, each.....	\$ 1.40	212A, used about 50 hours.....	\$25.00
NEW CG1182 Navy 5 watters, ea. 25c per DOZEN.....	1.00	RCA 852, slightly used \$14.00. RCA 211s, used.....	8.00
Manhattan Full wave high voltage rectifier tube No. 2721: rated 90 ma. 470 v., 45 ma. 800 v., cold cathode.....	.50	'03A's, used, SPECIAL AT.....	22.00
Ureco type 2L half wave receivers, 5 v. fil., each 15c; per dozen.....	.75	RCA 240 (hi-mu '01A) 3 for.....	2.00
W.E. 212D 250 watters, excellent modulators, practically new.....	35.00	National B-81, each.....	3.45
212D, used but in excellent condition.....	25.00	New DEFOREST 450s, each.....	3.25
		National B-3, each.....	3.90
		New DEFOREST 481s, each.....	3.00

**HIGH QUALITY TUBES—1000 hr. uncond. guarantee**

Hytron 210.....	\$ 1.75	Hytron '36 or '37.....	\$ 1.25
Hytron 48.....	.75	Hytron '38.....	1.25
Hytron 57.....	.65	RAVAC—90-day guaranteed 210's, each.....	1.20
Hytron 37 or 58.....	.60	Extra heavy '96s, spiral fil., cylindrical plate.....	3.35

**PUBLIC ADDRESS EQUIPMENT**

<b>SILVER MARSHALL BARGAINS</b>	<b>\$ 2.45</b>	No. 329 Power Trans. 2.200 v., 2-2 1/4 v. fil.....	<b>\$ 3.00</b>
No. 220 1st and 2nd stage AFT, ratio 3:1 flat 30 to 5000 cy.....	1.55	No. 275 RF choke, I.C. 2 1/4 mhy.....	.65
No. 221 Output transformer, Power stage to Hi-impedance speaker.....	2.40	No. 277 RF choke sectional unit, wound, 3 1/4 mhy.....	.75
No. 225 1st stage AFT, ratio 4:3:1.....	2.40	SM coil forms.....	.78
No. 220 2nd stage AFT, ratio 3.5:1, mate to No. 225.....	2.40	SM coils all ranges.....	.75
No. 228 Univ. Output choke PP '71, '45 or '50 to Hi-imp. speaker.....	1.95	Silver Marshall POWER TRANSFORMER built for 14 tube super, 110 v. pri. 750 v. CT, 5 v. 2 a. and 2 1/4 v. 16 a. secondaries, completely shielded, lug terminals, electrostatic shield, SPECIAL.....	5.75
No. 231 Output transformer PP '10 or '50 to speaker.....	1.95	Mallory-Elkon B-elim. for sets up to 6 tubes.....	\$11.70
No. 234 Univ. Output choke, single or PP '12, '71, '10, '46 or '50 to voice coil of dynamic speaker.....	1.65	Acme 180 v. B, 40 v. C, eliminator with tube.....	6.50
No. 255 1st stage AFT or Diekup input trans. ratio 4:2:1.....	2.45	9" cone AUTOMOBILE DYNAMIC SPEAKER.....	5.95
No. 256 2nd stage AFT, ratio 3.5:1, mate to No. 255.....	1.65	9" cone AUTOMOBILE DYNAMIC SPEAKER, 6 v.....	5.95
No. 4057 uniboke, Heavy duty infra. mod. for 14 tube super.....	1.95	Wright-DeCoster No. 107 speaker, Practically new.....	18.00
SM Alliget PP input transformers WHILE THEY LAST.....	7.50	1 only Audak No. 18 Theatre Pickup.....	15.00
No. 10132 Power Trans. 1030-0-1030 v., 150 ma. for 945's.....	15.00	2 only Photone pickups, 10" arm, Hi and low impedance, each.....	10.00
No. 10126 filter choke 11 by 200 mm 90 ohms DC res.....	7.50	O. E. Phono motors, watt-hour meter type with turn table.....	7.50
No. 10122 Output trans. PP 845 to 500/200 ohm imp.....	7.50		
No. 336U Power trans. 520 v. CT, 5 v. 3 a. 2-2 1/4 v. 1.5 v. 4a.....	3.50		

**HOT SPECIAL! LOFTIN-WHITE Amplifier. HOT SPECIAL!** Licensed by Electrad, built by Sprague Specialties for Home Talkie outfit, 224A 1st stage, 245 2nd stage, 250 rectifier. Amplification curve list clear up into the superonic and R.F. regions. Plenty of amplification, extremely small bulk, self-contained power pack, SPECIAL at..... **\$6.95**  
Sonicorode 8" dynamic speaker, 4000 ohm field, specially designed for above amplifier..... **3.95**

GR No. 395 Power Transformer 110 v. 60 cy. 550 v. CT.....	\$ 3.50	60 cy. pri. 1200 v. CT 5 v. CT, 2-2 1/2 v. fil. 2-25 hy. shielded case.....	\$ 8.75
GR No. 396 Double filter choke, low DC res., exposed.....	3.00	New WESTON milliammeters 0-50, SPECIAL at.....	3.00
Jenkins (Amertan) Television Power Unit, 115/130 v. New JEWELL milliammeter 0-5 to 0-500 ranges.....	\$5.40	Other NEW Weston milliammeters, 0-5 to 0-500 ranges.....	5.80

**SINGLE-SIGNAL SUPER KITS**

Everything you need to make this finest of all HF receivers. Jim Lamb's articles in Aug. and Sept. '32 QST give you all the dope. The ultimate in selectivity and sensitivity now available at a reasonable price. High quality materials, accurate workmanship, bargain prices.

88 Super kit (see Aug. '32 QST)..... **\$50.00**  
1P and AP amplifier kit (see Sept. '32 QST)..... **39.00**

**BEEDE METERS**

A moderate priced meter of quality; fills a long felt need for the amateur. 3 1/4" black enamel case, sensitive, well-damped D'Aronsal movement, zero adjustment; long scale, 3% accuracy

No. 701 Milliammeter, ranges 0-5 to 0-1000, DC res. each.....	\$ 3.32	15-dial, each.....	\$12.50
Baby mike—be your own announcer.....	.25	Riders Manual, Vol. I.....	5.00
Omnigraphs, 5-dial, each.....	\$ 6.50	Riders Manual, Vol. II.....	4.50
Teleplex, 3 taper.....	10.00	ARRL Log Books, 3 for.....	1.00
Ham Handbook, prepaid.....	1.00		
Latest Ham Callbook, prepaid.....	1.00		

Code learning apparatus for rent—WRITE!

**ARSCO PRODUCTS**

ARSCO 2-tube receiver.....	\$ 8.00	ARSCO Wavemeter, 20-40-80, indiv. calibrated.....	\$ 4.95
With cabinet.....	8.25	With 160 meter coil.....	5.95
ARSCO Senior PP 45 with Pack and tubes.....	16.25	80 or 160 meter crystal with holder.....	3.75

ARSCO power packs for National SW-3 and SW-5. Steel chassis and cover; tube and cable inc.; supplies all voltages—Pure DC, too, where you need it most. 3-tube size..... **\$10.50.**  
5-tube size..... **\$11.50**

**USED WAVEMETERS**

GR type 358, 14 to 230 meters. In wooden case with coils and cabinet.....	\$ 8.00	Jewell Pattern 174 Volt-ammeter and Wattmeter 50 cycle AC, 150 v., 1/4, 5, and 20 amps. Bakelite case, new condition; list \$80.00 SPECIAL.....	40.00
REL No. 184-111, 200-214 meters, walnut case.....	15.00		
Bu. Stan. by John Fitch, 1500-20,000 meter, switch for.....	15.00		

**CLASS B EQUIPMENT**

Arco No. 182 Power trans., 60 cy., 115 v. pri., 700 v. CT, 200 ma., 2 1/4 v., 7 amp., 2-2 1/4 v., 3 amp., sec., each.....	\$ 5.25	Circuit B mod. to 5000 ohm load, per pair.....	\$ 5.25
Arco No. 282 Power Trans., 60 cy., 115 v. pri., 830 v. CT, 200 ma., 2 1/4 v., 8 a., 2-2 1/4 v., 3 a., sec., each.....	5.75	Input and Output Transformers 2-48 to 4-40 Class B mod. in par. PP to 10,000 ohm load, per pair.....	17.00
For 25 cycles add 50% to above prices.		Input and Output Transformer 2-46 to 2-'03A Class B mod. to 2-'32 or 2-'03A, per pair.....	15.00
		Filter choke Arco No. 945 rated 20 hy., 200 ma., 50 ohms.....	2.10

**\$50.00 NATIONAL SW-5 ALL AC \$50.00**  
Complete with tubes, power pack and 4 sets of coils, for a short time only

Dumont A Eliminator, carries up to 6 tubes.....	\$8.75	This week's <b>CARD WAVE</b> , special! Type 123-B, 440 mmf., 31 plate, each.....	2.95
Type 147-B, 440 mmf., 3000 volt transmitting condensers, each.....	\$4.95	Type 402-B, 50 mmfd., Midway.....	1.30

**RESISTORS**

Pixtal Carbon Resistors, 1 watt, each 10c; per dozen 75c; per C. assorted.....	\$ 5.00	Asbestos covered 85 watt wirewound resistors, 1050 ohms, each.....	\$ 0.40
Pixtal Carbon Resistors, 2 watt, 15c each; per dozen \$1.25; per C. assorted.....	7.25	Metal covered wirewound slider potentiometer, 10" long, power type 1000 ohms, each SPECIAL at.....	1.75

**SEND FOR FREE HAM SHEET AND CATALOG**

**UNCLE DAVE'S RADIO SHACK**

LONG DISTANCE PHONE 4-5746

356 BROADWAY ALBANY N.Y.

### ALDEN S.W. COILS

Precision wound coils with the convenient gripping-ring for easy insertion and removal from socket.

Set of four precision wound short-wave coils—20 to 200 meters with .00014 mfd. condenser. 704SWS List Price \$2.00 set. Set of two coils to cover 100 to 540 meters with .00014 mfd. condenser. 704SWW and 704SWO. List Price \$1.50

**Genuine Makalot Coil Forms** with color-coded easy-grip rings. 1 1/4 in. dia. x 2 in. winding space. Red, Yellow, Green or Blue. 704—4-pin coil form. List... 25c 705—5-pin coil form. List... 25c 706—6-pin coil form. List... 30c

**Alden Code Set**  
Adjustable pitch buzzer—highly polished nickel plated metal parts. Code molded in beautiful black Makalot base. Regulation key knob. 3 binding posts for connecting phones or using in two-way operation. Boxed with illustrated directions. Code Set. List Price... 75c

Send 10c for 40-page Adapter Data Booklet—over 300 diagrams with directions, tube connections, analyzer rewiring instructions, etc.

**ALDEN PRODUCTS CO.**  
Dept. SW4 715 Center St. BROCKTON, MASS.

To Assure the PEAK EFFICIENCY of the DOUBLET ANTENNA and the NOISE REDUCTION of the TRANPOSED TRANSMISSION LINE

**NATIONAL HAS CHOSEN LYNCH**

SHORT WAVE ANTENNA PRODUCTS FOR THE NEW F-7

RESULT—  
**The LYNCH Short Wave Antenna Kit**

**KIT CONTAINS**  
15—LYNCH Transposition Blocks—(These Blocks Are Non-Hygroscopic, Low Capacity and Lowest Power Factor)  
8—LYNCH Commercial Type Insulators (Same High Quality Insulating Material As The Transposition Blocks)  
1—LYNCH Doublet Coupler (Transmission—Line Impedance-Matching Device)  
125 ft. Enamelled Short Wave Antenna Wire  
1—Thoroughly Practical and well illustrated instruction booklet

**LIST PRICE, Complete \$5.00**  
At All Lynch and National Jobbers.

Though Designed Especially for the F-7 The Lynch Short Wave Antenna Kit Will Improve The Performance of Any Receiver.

**LYNCH MANUFACTURING CO., Inc.**  
711RP—General Motors Bldg., New York, N. Y.  
Makers of the famous Lynch Resistors

**FREE**

**13th ANNIVERSARY RADIO CATALOG**

132 pages containing the most complete listing of radio items for the amateur and experimenter at real bargain prices.

Send for your copy now!

**AMERICAN SALES COMPANY**  
Wholesale Radio Distributors  
SW-44 W. 18th St., N. Y. C.  
The Oldest Amateur Supply House, Est. 1919

**SHORT WAVE SENSATION!**  
Science has perfected a new device that will bring in Short Wave Stations with loud speaker volume. Easily attached to any radio. Packed with "thrills." C. H. Smith, 9885 Candler Bldg., Kansas City, Mo., wants local agents and will send a no-cost sample. So write him today.

**3 Years Hence**

You will be interested in tracing the early developments of Short Waves. Your best source of information will be **SHORT WAVE CRAFT**. Back numbers may be had at 25c per copy. Address: **SHORT WAVE CRAFT**, 96 Park Pl., New York.

- 2 sets of plug-in coils for modulator or first detector and oscillator, wound as described in the text and also illustrated in special coil drawing.
  - 1 "plate" and "heater" current supply, utilizing separate 2 1/2 volt transformer, if desired, with 180 volt plate supply taken from a well-filtered "B" power-pack.
  - 2 .0005 mf. tuning condensers, Hammarlund (National).
  - 4 .0001 to .0005 mf. semi-variable condensers "XL" type, G5.
  - 7 .01 mf. moulded condensers.
  - 3 .001 mf. moulded condensers.
  - 3 .0003 mf. moulded condensers.
  - 9 .5 mf. by-pass condensers.
  - 1 1 mf. by-pass condenser.
  - 5 1,000 ohm flexible resistors.
  - 4 grid leaks; R7—20,000 ohms; R8—125,000 ohms; R9—125,000 ohms; R10—1 megohm (one million ohms). Lynch.
  - 1 22,500 ohms one watt resistor, R6. Lynch.
  - 3 150 ohm one watt resistors, R11, 12, and 13. Lynch.
  - 1 33,000 ohm one watt resistor, R14. Lynch.
  - 2 50,000 ohm one watt resistors, R15, 22. Lynch.
  - 2 100,000 ohm one watt resistors, R16, 23. Lynch.
  - 1 2,700 ohm one watt resistor, R17. Lynch.
  - 1 50,000 ohm potentiometer, R18, regeneration control. Clarostat.
  - 2 10,000 ohm Electrad wire-wound resistors (with sliders), R19, R21.
  - 1 5,000 ohm variable resistor, R20, volume control, Frost (Clarostat).
  - 1 100,000 ohm variable resistor (R24, tone control and static damper), Frost (Clarostat).
  - 1 3,000 ohm one watt resistor, R25. Lynch.
  - 4 50 millihenry R.F. chokes, shielded type, Hammarlund (Gen-Win).
  - 1 60 millihenry R.F. choke, Aero or other type, such as Hammarlund or National (Gen-Win).
  - 1 Silver-Marshall No. 255 audio transformer, A.T., or equivalent of resistance, capacity, impedance unit.
  - 1 Front panel, bakelite or aluminum 20.5 inches long and about eight inches high (or to suit your cabinet) Blan.
  - 7 tubes; 2—27 type; 2—24 type; 3—35 type.
  - 9 tube sockets, 5-prong—Na-ald.
  - 6 Binding posts, Eby.
  - Shielded and ordinary hook-up wire and a length of No. 14 bare copper wire for bus wires.
  - Various angles, screws, soldering lugs, etc., as needed.
- Names in brackets indicate optional choices of well-known trade items.

## A Crystal Detector Wavemeter

(Continued from page 735)

ly, especially when the frequency is being shifted all over the range. In this case it becomes exceedingly difficult to locate the signal at each adjustment.

### Crystal Detector Better Than Thermo-Galvanometer

A wavemeter such as is shown in Fig. 1 at (d) using a thermo-galvanometer seems to be the best system. However, the price of a thermo-galvanometer is startlingly high compared to other equipments, and the author was hunting for some other method for indicating radio frequency when he ran onto an old friend doing graduate work at the University of Kansas. This young man, Mr. Wayne Hall, was using a crystal detector for the purpose, as he claimed it was much more sensitive than a thermo-couple. The author immediately set to work finding the best arrangement of parts for a five-meter wavemeter using this system.

Figure 2 shows the graph of current through a crystal detector, plotted against potential. It can easily be seen that the crystal favors voltage in one direction, that is, it offers a much lower resistance to potentials in one direction than it does in the other. In the case of galena, a large number of measurements showed ratios as high as 10,000 ohms in one direction and 400 ohms in the other. Of course, it is possible to obtain contacts which will give much better results than this, and the reverse is also true. Hence an alternating current will be rectified if it is allowed to flow through the crystal. The frequency of the alternating current does not seem to make much difference, hence it can be used to change radio frequency current into a direct current, which will operate the usual direct current meters.

The rectification in crystals is usually attributed to the Peltier effect. It is a well-known fact that when a current passes across the junction of two dissimilar metals, heat is either generated or absorbed depending on the direction. It is quite possible that such an effect occurs between the catwhisker of the detector and the crystal face. It is by no means a settled point, but it is commonly thought that this effect is certainly some sort of thermoelectric effect, which causes a crystal detector to act somewhat like a thermo-couple, only many times more sensitive. Prof. Morecroft in his "Principles of Radio Communication" covers the subject at some

length, and the reader is referred to this treatment, if he cares to delve further into the mystery.

Different types of crystals give different results and have different average resistances. Carborundum crystals, for example, will operate with exceptionally heavy contacts, although they are not very sensitive. Probably the most sensitive crystal is galena, whose greatest fault is that it requires a light contact and therefore is easy to jar out of adjustment.

### Best Circuit for Crystal in Wavemeter

The development of the actual wavemeter circuit used in these tests was exceedingly simple. At first a crystal detector was connected in series with an 0-1 milliamperemeter and used in the circuit shown in Fig. 3 at (a). This meter gave full scale deflections as far away as 12 to 14 inches from the oscillator, at which distance no effect could be noticed, when the wavemeter was tuned to the wave in the

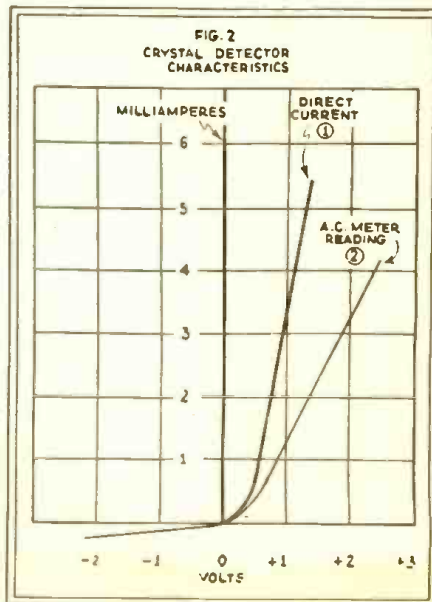

Curves showing characteristics of crystal detectors.

plate millimeter of the oscillator. The tuning, however, was not all that could have been desired, as it was very broad. It was possible to tune to about 3 points on a dial graduated from 0-100, which was slightly discouraging. After hunting up a great many wavemeter circuits, the one shown in (b) of Fig. 3 was located. The results were astounding! The meter deflected even farther than before, and the tuning was so sharp that it became necessary to arrange a vernier for proper adjustment! The accuracy of tuning was as close as could be read on the dial, which was about 1 part in 500!

Experiments were then devised to show the result of close coupling of an absorption-type wavemeter. When the coil of the tuned meter was within 1 inch of the plate tank coil, the crystal wavemeter read 85.33. When the absorption wavemeter was moved to 3 inches the crystal wavemeter read 85.5 and when the absorption meter was removed, the crystal wavemeter read 85.6, showing that the absorption wavemeter was affecting the frequency of oscillation considerably. It has been clearly shown that the results of coupling a tuned circuit to the plate tank and tuning for plate current dip is not a precise method at all.

**Accurately Made Coil Essential**

A few mechanical precautions should perhaps be mentioned at this point. The wavemeter coil should consist of a single loop of heavy wire, having stops soldered to the ends so that the coil will assume the same position, every time it is replaced in the wavemeter! All wiring should be done with heavy wire, and all joints well soldered. The pickup coil consists of two turns of wire. The size does not especially matter, as does the length of leads in the indicating circuit. Almost any crystal detector will "fill the bill." If a sensitive milliammeter is on hand, the experimenter is advised to try carborundum. Meters of as low a sensitivity as 0-15 milliamperes have been used, although the lower sensitivity meters do not give as accurate readings.

In the experiments carried on at the First National Television Corporation, Lecher wires were used for calibration purposes, a check being taken with a standard harmonic oscillator later on.

The author has tried not to tie the discussion down to any particular arrangement of parts, with a view toward leaving the circuit open for improvement by the experimenter. So little has been done on the ultra short wave bands that it is impossible to state that certain given sizes of condensers and coils will give the best results in all cases. The parts used by the author in the final wavemeter are shown below:

**Parts List for Crystal Wavemeter**

- 23 plate (Cap.=.0001 mf. or 100 mmf.)
- Pilot midget condenser (smaller will spread band) better if desired
- L<sub>1</sub> L<sub>2</sub> wavemeter coils shown in Figure 4
- Crystal detector
- Milliammeter 0-15 M.A. scale: Weston
- Remler dial (removable paper graduations recalibrated for direct reading)

**Calibrating Wavemeter With a Lecher Wire System**

Perhaps the easiest way to calibrate the finished wavemeter is by means of Lecher wire measurements. If the proper precautions are taken, the results obtained will be quite accurate. A pair of wires are stretched about 4 to 5 inches apart, a distance of about 18 to 20 feet. It is surprising how little difference will be observed with changes in these constants. The system makes use of the fact that radio waves are propagated along a wire of small diameter and good conductivity at practically the speed of light. The ends are fastened in a small loop and the resultant coil loosely coupled to the oscillator. If a flashlight bulb is arranged with the ends connected between a pair of short wires which can be used to span the Lecher wires, the points of maximum and mini-

**THE WHOLE WORLD SPEAKS—**

**Thru**

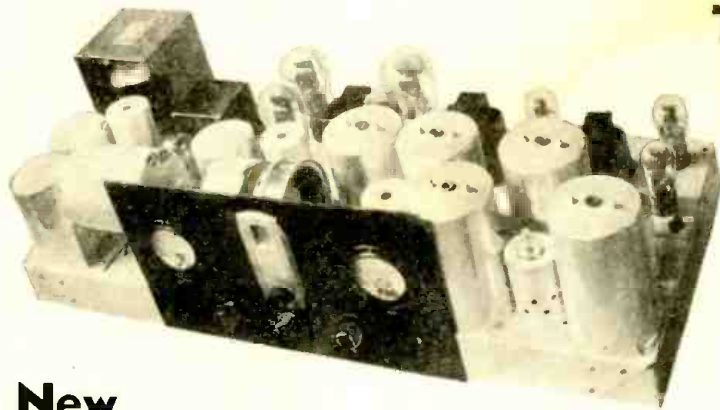

**The New**

**ADMIRALTY SUPER-15**

MULTI-WAVELENGTH SUPERHETERODYNE

In design and engineering, the world's most advanced Radio Receiver. This great new 16-Tube Model opens up a vast new stage of magnificent entertainment.

Dependable long distance reception with the lure of overseas programs via short waves, as well as your favorite broadcasts as they originate at the station. This is the true Romance of Radio that awaits you.

The Admiralty Super-15 provides the maximum in sensitivity, selectivity and quality of reproduction ever promised.

Complete literature sent on request. Address

**NORDEN-HAUCK ELECTRIC & MFG. CO.**

402 Cherry Street, Philadelphia, Pa. U. S. A.

"Builders of the Highest Class Radio Apparatus in the World."

**TRANSFORMERS! CHOKES!**

Manufactured by MASTERS in that line. You take no chance! Every item FULLY GUARANTEED. (Mentioning manufacturer's name prohibited.)

AMATEURS! SERVICEMEN! Buy your requirements from us and SAVE MONEY always. A trial order will convince you of the merit of these transformers and chokes, and extra PROFITS you will make.

**Filament Transformers—Receiving and Transmitting Types:**

2 1/2 volts at 12 A.C.T.; 5 Volts at 2 A.C.T.—(semi-cased) .....	\$1.10
2 1/2 volts at 12 A.C.T.; 2 1/2 V. at 3 A.C.T.; 5 V. at 2A.—(semi-cased) .....	1.25
Sec.—7 1/2 V.C.T. at 3 A.; 7 1/2 V.C.T. at 3 A.—(cased) .....	3.75
Sec.—10 Volts C.T. at 7 A.—(cased) .....	3.75
Sec.—12 Volts C.T. at 7 A.—(cased) .....	3.75
Sec.—2 1/2 Volts C.T. at 12 A.—(cased) .....	3.75
Sec.—5 Volts C. T. at 20 A.—(cased) .....	5.50
Sec.—2 1/2 Volts, 3 ambs. (semi-cased) .....	1.45

**Power Transformers**

700 V.C.T. at 100 M.A.	575-575 Volts at 100 M.A.
5 Volts at 2 A.	7 1/2 Volts at 3 A.C.T.
2 1/2 Volts at 3 A.C.T.	7 1/2 Volts at 3 A.
2 1/2 Volts at 12 A.C.T.	2 1/2 Volts at 12 A.C.T.
Semi-cased .....	Semi-cased .....
401-400 Volts at 100 M.A.	300-300 Volts at 60 M.A.
5 Volts at 2 A.	5 Volts at 2 A.
2 1/2 Volts at 3 A.C.T.	5 Volts at 1/2 A.C.T.
2 1/2 Volts at 12 A.C.T.	1 1/2 Volts at 9 A.
Semi-cased .....	2 1/2 Volts at 2 A.C.T.
Cased .....	Semi-cased .....
	Cased .....

**Midget Transformers**

325-325 Volts at 60 M.A.	325-325 Volts at 60 M.A.
5 Volts at 2 A.	5 Volts at 2 A.
2 1/2 Volts at 2 A.	2 1/2 Volts at 9 A.C.T.
2 1/2 Volts at 9 A.C.T.	Semi-cased .....
Semi-cased .....	

330-330 Volts at 50 M.A.	330-330 Volts at 60 M.A.
2 1/2 Volts at 7 A.C.T.	2 1/2 Volts at 9 A.C.T.
5 Volts at 2 A.	5 Volts at 2 A.
Cased-horizontal mounting .....	Cased-horizontal Mtr. ..

**Class "B" Transformers**

350-350 Volts at 200 M.A.	415-415 Volts at 200 M.A.
2 1/2 Volts at 7 A.	2 1/2 Volts at 8 A.
2 1/2 Volts at 3 A.	2 1/2 Volts at 3 A.
2 1/2 Volts at 3 A.	2 1/2 Volts at 3 A.
Semi-cased .....	Semi-cased .....

**Transmitting Plate Supply Transformers (Semi-cased)**

375 V.A. Sec.-3000 Volts C.T., 2000 Volts C.T. ....	\$7.75
850 V.A. Sec.-4000 Volts C.T., 3000 Volts C.T. ....	10.50
Sec.-1500 Volts C.T. at 300 M.A., 7 1/2 V. e. L. at 3 A., 7 1/2 V. c. t. at 3 A.	5.95
Sec.-2000 Volts c. t., 1500 Volts c. t. at 300 M.A.	7.00
850 V.A. Sec.-5000 Volts c. l., 3000 Volts c. t. ....	12.50
Sec.-1000 Volts C. T. at 150 M.A.	4.50
Sec.-1500 Volts C. T. at 150 M.A.	4.50
Transmitter Filter Choke 30 Hy., 300 M.A.—Sturdy built.	6.75
Transmitting Filter Choke 30 Hy., 150 M.A.—Sturdy built.	3.15

We stock a COMPLETE line of transformers, filter chokes, modulation chokes, input and output transformers, etc., for every purpose. Write for our LOW prices for your requirements. Distributors of nationally known radio equipment. FREE BULLETIN.

**MAURICE SCHWARTZ & SON** 710-712 Broadway Schenectady, N. Y.

(Please mention "Short-Wave Craft" when writing)

**"Ham" advertisements are always interesting and profitable to read.**

**See Page 755.**

# DATAPRINTS

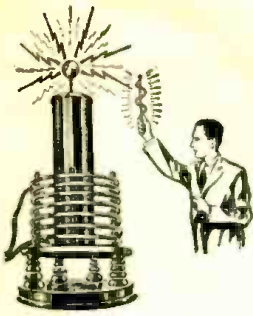

Give  
Technical  
Information  
on the  
Building  
of  
Worthwhile  
Apparatus

Dataprint containing data for constructing this 3 ft. spark Oudin-Tesla coil.

..... \$ 75  
Includes condenser data.

## OTHER "DATAPRINTS"

### TESLA OR OUDIN COILS

- 36 inch spark, data for building, including condenser data ..... \$0.75
- 8 inch spark, data for building, including condenser data ..... 0.75
- Violetta type, high frequency coil data; 110 volt A.C. or D.C. type; 1" spark; used for giving "violet ray" treatments ..... 0.75
- How to operate Oudin coil from a vacuum tube oscillator ..... 0.75

### TRANSFORMER DATA

- Any size, 200 to 5000 watts. (1 primary and 1 secondary voltage data supplied—specify watts and voltage desired) ..... \$1.00
- 1 k.w. 20,000-volt transformer data, 110-volt, 60-cycle primary. Suitable for operating 3 ft. Oudin coil ..... 0.50
- 1/2 k.w. 15,000-volt transformer data, 110-volt, 60-cycle primary. Suitable for operating 8-inch Oudin coil ..... 0.50
- Induction Coils—1 to 12 inch spark data ..... 0.75

### MAGNET COIL DATA

- Powerful battery electro-magnet; lifts 40 lbs. .... \$0.50
- 110 Volt D.C. magnet to lift 25 lbs. .... 0.50
- 110 Volt D.C. solenoid; lifts 2 lb. through 1 inch ..... 0.50
- 110 Volt D.C. solenoid, lifts 6 lb. through 1 inch ..... 0.50
- 12 Volt D.C. solenoid, lifts 2 lb. through 1 inch ..... 0.50
- A. C. Solenoid, powerful, 110-volt, 60-cycle ..... 0.50
- MOTOR—1/16 H.P., 110 volt A.C. 60 cycle (suitable for driving 12" fan or light apparatus), constructional data ..... 0.50
- 1200 cycle Synchronous motor ..... 0.50
- 60 cycle Synchronous motor ..... 0.50

**TELEGRAPHONE**—Records Voice or "Code" signals on steel wire by magnetism. Code can be recorded "fast" and translated "slow". Construction data (special) ..... \$0.50

**CLOCKS**—Electric chime ringer. How to make one to fit on any ordinary clock ..... 0.50

### MISCELLANEOUS DATAPRINTS—

- Electric Ice Skates—How to make ..... 0.50
- How to Thaw Pipes by Electricity ..... 0.75
- 20 motor circuits—hook-ups ..... 0.75
- 20 practical telephone hook-ups ..... 0.50
- Treasure Locator ..... 0.50
- 100 mechanical movements for Inventors ..... 0.50
- Polarized Relay—Ultra Sensitive ..... 0.50
- Electro-medical coil (shocking coil) ..... 0.50
- REFRIGERATION MACHINE**—Dataprint—How to Make Data ..... 1.00

### SLIDE RULES—Specially Selected

- Students' 10-inch wood slide rule, accurately engraved (prepaid) ..... \$1.10
- ELECTRICAL** Slide Rule, 10 inch size, with special electrical law ratios and indexes. wood with white ivory scales, prepaid ..... 5.75
- 5" "Pocket" slide rule ..... 4.00
- "Circular Pocket" slide rule. Fits vest pocket. 2 1/2" diameter, leather case ..... 4.00
- Student's circular slide rule ..... 1.50

(Postage 10 cents extra on last three slide rules.)

**The DATAPRINT COMPANY**  
Look Box 322 RAMSEY, N. J.

imum voltage existing between the wires can be located. It will generally be found advisable to use several wooden spacers to separate the Lecher wires, as this avoids the necessity for stretching the wires tightly. Any wire from No. 14 to No. 18 bare copper wire will prove satisfactory, although the author does not recommend the use of stranded wire. Several points will be located, where minimum and maximum indications are obtained. It will generally be found advisable to experiment with the flash lamp used as an indicator a while before attempting to make a calibration.

When the experimenter is fairly familiar with the equipment and its various phases of operation, the oscillator should be set for the lowest frequency and this point located on the wavemeter. The flashlight bulb should then be passed along the Lecher wire set-up, until a point of maximum intensity is located. This point should be marked and the operation continued until the following point of minimum intensity located. The distance between the maximum and minimum points is a *quarter wavelength*. If the wires are long enough, a second maximum should be located. The distance between the two maximum points is exactly a *half wavelength*. If the distance measurements are made in inches, divide the results obtained by 39.37, that is:

$$\frac{\text{Wave length in inches}}{39.37} = \text{wavelength in meters}$$

or

$$\frac{\text{Distance between maximum indications in inches}}{19.68} = \text{W.L. in meters}$$

Now increase the oscillator frequency and continue the operations until sufficient points have been located to plot a curve of wavemeter readings against wavelength. If the frequency readings are desired, it can be obtained by:

$$\frac{300,000,000}{\text{wl in meters}} = \text{frequency in cycles}$$

or

$$\frac{300,000}{\text{wl in meters}} = \text{frequency in kilocycles}$$

It is not necessary to locate more than 10 or 15 points for calibration purposes, if these are ascertained carefully. It will be noticed that if a smooth curve is drawn thru the points obtained, all errors in reading and locating exact distances along the Lecher wires will be eliminated. Furthermore, the quarter wavelength distance can be used as a check on the half wavelength readings. As a parting bit of advice, *take your time* on this calibration and the results will be well worth while, since once the wavemeter is calibrated, it is a simple matter to accurately determine the wavelength of any high frequency oscillation within the wavemeter range.

## An All-Purpose Receiver

(Continued from page 718)

lated oscillator. Connect phonograph pick-up at same points with the adapter; if a "mike" is used, connect the secondary of the microphone transformer to the same points. In either case the detector tube must be oscillating. Connections to the antenna may be made by either of the two methods referred to above. For C.W. use a key may be placed in the negative "B" lead; coverage of several miles can be expected. More "B" battery voltage may be used if desired.

### Wavemeter

The set is a very good *wavemeter*, and the calibrations made when used as a receiver are accurate when used as a wavemeter provided the detector tube is left in the set. If it is removed recalibration is necessary due to capacity change. The flashlight bulb "FB" may be left in the circuit at all times, as has been done, with no detrimental effects. If you want it removed merely short-circuit its socket. The batteries of course are disconnected.

### Monitor

Now for the monitor—that was a big order until the writer noticed his wife's large tin cracker-box; that did the trick! The receiver was tuned to the amateur band, within which a C.W. transmitter was working; then the whole business—set and batteries—was placed in the box, the phone cord alone coming out where the hinged cover of the cracker box was sprung slightly. The transmitter was started up and its *tank condenser* varied until the "beat" note was heard in the phones. A perfect monitor. The transmitter was pronounced O. K. and reset to the exact frequency by disconnecting the batteries from the receiver and taking it bodily in one hand holding it so that its coil was close and inductively coupled to the transmitter tank coil. The bulb "FB" glows brilliantly when resonance is established.

The photo of the interior shows a small aluminum shield covering about 2 1/2" of the under side of the panel; this shield also projects down to the bottom of the wooden cabinet, eliminating *hand capacity*. It is automatically grounded by contact with the condenser rotor. This photo shows also the 0.1 mf. by-pass condenser

soldered on the tin cover of the 50,000 ohm Centralab regeneration control. The flashlight bulb and the socket at the top of panel constitute the wavemeter indicator; they are mounted to the side of the cabinet nearest the coil. Two small screws hold the socket in place. The bulb need never be removed. Three wires about three feet long are brought out through a hole in the cabinet for battery leads.

### Coil Winding Data

This device is not a "theory job" but one built and actually in use now. It will repay the builder immensely for the little trouble of construction and all will agree "it's the handiest tool around the place." Other uses will present themselves as the demand arises.

Coil specifications are as follows:

Approx. Range	Primary	Secondary	Tickler
15-25	3	4 1/2	3 1/2
25-50	4	10 1/2	4
50-100	5	22	5
100-250	7	45	7
250-600	15	135	25

The secondaries of the first four coils are wound with No. 22 D.S.C., the two smaller coils having their grid coils single spaced. The primaries and ticklers of all five coils are wound with No. 28 D.S.C. The grid coil is at the top of form, tickler next, without leaving a space, then space about 3/8" or 1/2" and wind primary (antenna coils). All coils are wound in the same direction and five prong Pilot coil forms are used for the first four coils. The 250 to 600 meter coil is wound on a longer form (Bud) the primary and secondary being adjacent, the tickler wound on a cardboard tube and placed just inside the top of coil form. Duco cement holds it in place. All wire for this coil is No. 28 D.S.C.

The intermediate frequency coil is the easiest—two 10 to 15 millihenry chokes (grid and plate coils) only are used and both are placed within a five prong tube base and connected as all other coils; the "K" prong is disregarded, of course, because no primary is used here. Other sizes of chokes from 300-1500 turns may be tried for special purposes. The writer

## "HAM" ADS

Advertisements in this section are inserted at 5c per word to strictly amateurs, or 10c a word (8 words to the line) to manufacturers or dealers for each insertion. Name, initial and address each count as one word. Cash should accompany all "Ham" advertisements. No less than 10 words are accepted. Advertising for the May issue should reach us not later than March 18.

**A RARE BARGAIN—THE COMPLETE OUTFIT** illustrated on page 662, March issue Short Wave Craft. National SW-3 AC-DC short-wave receiver, spotless condition, with five pairs of regular coils covering 14-200 meters and special 20 and 40 meter band spread coils (14 coils all told), quiet AC power pack as described in article, and separate 45 pushpull power amplifier with self-contained power unit—a marvelous combination for the short wave fan, all in perfect order. Worth easily \$65. First money order for \$32 takes whole outfit, express collect. Robert Hertzberg, 3953-47th Street, Long Island City, N. Y.

SEND FOR LIST 200 TRANSMITTING ACCESSORIES, Howard, 5508 Fulton, Chicago.

SWLS, QSLs 200 For \$1.00, SAMPLES, Foster Press, Appleton, Wis.

**SENSATIONAL MICROPHONE VALUE—UNIVERSAL model "Y"**—Experimenters single-button, watch model type, 200 ohms. Pure gold spot center diaphragm. Only \$2.00, including valuable 1933 general catalog with diagrams. Universal Microphone Co., Ltd., Inglewood, California.

SWLS PRINTED TO ORDER. SAMPLES, prices on request. W2AEY Press, 338 Elmora, Elizabeth, N. J.

SHORT WAVE APPARATUS BUILT TO ORDER. W5BNM, Uncas, Oklahoma.

**A M A T E U R S, EXPERIMENTERS—THIS MONTH**, crystals for 95c in 80 or 160 meter band. Low frequency bars, for receivers, etc. \$2.50. Absolutely guaranteed OK. White Radio Lab., Peru, Ill.

TRANSFORMERS REWOUND OR BUILT TO your order. Speaker, field coils. Pemberton Laboratories, 921 Parkview, Fort Wayne, Ind.

FOR SALE: PILOT SUPER WASP. COILS, tubes, power pack, completely wired like new, \$22.50. Must sell at once. Albert Bruce, Mt. Carmel, Ill.

SHORT WAVE LISTENERS CARDS: JUST what you need for reporting the stations you hear. Write for free samples today. WIBEF, 16 Stockbridge Ave., Lowell, Mass.

FOR SALE: NATIONAL "SW5" THRILL BOX, A-C operated, power supply and 6 sets of plug-in coils—\$30.00 complete. Thomas Beck, 3140 West 94th Street, Cleveland, Ohio.

QSLs, SWLS—QUALITY PRINTING. LOWEST prices. Free samples. Radio Press, Box 212-W, Monroe, N. C.

SHORT WAVE CONSTRUCTION KITS, SETS, Supplies. Wholesale Catalog 5c. Federal Radio & Telegraph Co., 4224 Clifford Road, Cincinnati, Ohio.

PLUG-IN COILS. SET OF FOUR WOUND on Bakelite four prong forms, tune with .0001 condenser .75 Per set. Tuning dials 2 inch .15—3 inch .20. Tube bases .05, .0001 condensers .50. Noel, 419 Mulberry, Scranton, Pa.

CORNER STRIPS FOR BUILDING METAL shielding and cabinets. R. H. Lynch, 970 Camulos St., Los Angeles, Calif.

QSLs 90c A HUNDRED, 2 COLORS, W9DGH, 1816 Fifth Ave., N., Minneapolis, Minn.

1500 MILE CRYSTAL CIRCUIT, 6 OTHERS, including new selective circuit operating speaker. Blueprint 25c coin. Modern Radiolabs., 1508-23rd Ave., Oakland, Calif.

DIZZY CARTOON FOR QSL OR SHACK. Send \$2 with your rough idea for large original pen drawing. W1AFQ, Harwich, Mass.

ANNOUNCING THE NEW "EXPLORER"—low-priced Short Wave kits and receivers. One, two and three tube models. Postcard brings free catalog. Rim Radio Mfg. Co., 691 Grand Street, Brooklyn, N. Y.

EX-OPERATOR ORGANIZING CLASSES FOR code practice, beginners and advanced. All speeds. \$1 week. If interested write. Hart, 3547-34 Street, Astoria, L. I., N. Y.

used 800-turn coils each. If this coil doesn't oscillate, reverse tickler connections. Wax may be poured into the tube base, holding the coils solidly. For a test of oscillation place this coil in the set and apply voltages, turning the regeneration control on full and setting whole unit near a broadcast receiver which is operating; if oscillating a whole string of beat notes will be heard as the tuning dial is rotated.

### List of Parts:

- 1—0002 mf. Hammarlund Midget variable condenser
  - 1—0001 mf. Sangamo fixed condenser with clips
  - 1—Grid-leak two to seven megohms
  - 1—00035 mf. fixed regeneration by-pass condenser
  - 1—0.1 mf. by-pass condenser
  - 1—80 mmf. Hammarlund "equalizer" condenser
  - 1—50,000 to 100,000 ohm Centralab variable resistor (Clarostat)
  - 1—10 to 50 ohm filament rheostat
  - 1—short-wave R.F. choke
  - 1—Hedgehog audio transformer (1 to 4 ratio)
  - 1—Pilot five-prong socket (or Na-ald)
  - 2—Pilot four-prong sockets (or Na-ald)
  - 4—Pilot five-prong plug-in coil forms (Gen-Win)
  - 1—Bud five-prong plug-in coil form (Gen-Win)
  - 1—Five-prong tube base
  - 1—5"x6½" bakelite panel
  - 1—Wooden cabinet 5"x6½"x2½" (inside dimensions)
  - 1—Wafer adaptor (grid to filament)
  - 1—3" dial for tuning condenser
  - 2—knobs for rheostat and regeneration control
  - 1—Flashlight bulb and socket
  - 1—Phone tip and jack
  - 1—Small battery clip
  - 2—10 to 15 mh. R.F. chokes
  - 2—Fahnestock clips
- Tubes, batteries, hook-up wire, and hardware wind up the list of parts.

## Mr. Myers Modernizes His 3-Tube S-W Receiver

(Continued from page 717)

istance not to exceed 0.5 megohm may be employed under self-bias conditions. Without self-bias, the grid leak resistance should not exceed 50,000 ohms.

An OUTPUT TRANSFORMER should be used in order to supply power to the winding of the reproducing unit. The optimum value of load resistance for the output device is 7000 ohms. For best results, the impedance in the plate circuit of the 47 over the entire audio-frequency range should be as uniform as possible.

The BLUE GLOW which frequently appears on the inner surface of the 47 bulb is due to fluorescence, caused by stray electrons from the filament which strike the interior of the getter-coated bulb. This fluorescence is a natural effect and is in no manner an indication of the performance of the tube.—Editor.

### Data for Coils in Myers Receiver

Range	L2	L3	L4
18-26 meters	6 turns	1 turn	6 turns
37-63 meters	10 turns	1 turn	15 turns
61-100 meters	15 turns	1 turn	30 turns
100-190 meters	2 turns	2 turns	60 turns

All wind with No. 28 DSC on five-prong forms.

### Constants of the Circuit

- C—0.06 mf. mica condenser
- C1—3 plate midget condenser
- C2—50 mmf. condenser
- C3—100 mmf. fixed condenser
- C4—100 mmf. fixed condenser
- C5—1 mf. fixed condenser
- C6—.01 mf. fixed condenser
- R1—300 ohm, 1 watt resistor
- R2—100,000 ohm, 1 watt resistor
- R3—5 megohms
- R4—500,000 ohm potentiometer
- R5—1,000 ohm, 1 watt resistor
- R6—50,000 ohm potentiometer
- R7—30 ohm center tap resistor
- L1—100 turns on half inch form
- L5—Aero Hi-Peak coupler
- L6—National S-101 coupler

## NEW SENSATIONAL OFFER

# Learn RADIO

## PAY FOR TRAINING AFTER YOU GRADUATE



To a few honest fellows I am offering an opportunity to get a training and pay for it after they graduate in easy monthly payments. You get Free Employment Service for life. And if you need part-time work while at school to help pay expenses, we'll help you get it. Coyne is 33 years old. Coyne Training is tested—You can find out everything absolutely free. Just mail the Coupon for My Big Free Book.

## Jobs Leading to Salaries of \$50 a Week and Up

Jobs as Designer, Inspector and Tester—as Radio Salesman and in Service and Installation—as Operator or Manager of a Broadcasting Station—as Wireless Operator on a Ship or Airplane, as a Talking Picture or Sound Expert—Hundreds of Opportunities for fascinating Big Pay Jobs!

## 10 Weeks' Shop Training AT COYNE IN CHICAGO

We don't teach you from books. We teach you by Actual Work on a great outlay of Radio, Broadcasting, Television, Talking Picture and Code equipment. And because we cut out useless theory, you get a practical training in 10 weeks.

## TELEVISION Is Now Here!

And Television is already here! Soon there will be a demand for Television Experts! The man who gets in on the ground floor of Television can have dozens of opportunities in this new field! Learn Television at Coyne on the very latest Television equipment.

## Talking Pictures A Big Field

Talking Pictures, and Public Address Systems offer golden opportunities to the Trained Radio Man. Learn at Coyne on actual Talking Picture and Sound Reproduction equipment.

## Get the Facts

Don't spend your life slaving away in some dull, hopeless job! Don't be satisfied to Work for a mere \$20 or \$30 a week. Let me show you how to make Real Money in Radio—the fastest-growing, biggest money-making game on earth! Get my big Free book and all details of my pay after graduation offer. Mail the coupon today.

H. C. LEWIS, President  
Radio Division, Coyne Electrical School  
500 S. Paulina St., Dept. 43-2K, Chicago, Ill.

Dear Mr. Lewis:  
Send me your big Free Book; details of your Free Employment Service; and tell me all about your special offer of allowing me to pay for training on easy monthly terms after graduation.

Name .....

Address .....

City..... State.....

# The CATALOG

## OF SHORT WAVE SETS, CONVERTERS, COILS AND EQUIPMENT!



Wholesale's great new 1933 catalog lists the latest in Short Wave Sets, coils and equipment! This Big 152 page Book should be before you—if you are thinking of short wave equipment.

### MORE THAN 10,000 BARGAINS

You can buy anything you want in Radio from the world's largest company of its kind through this BIG BARGAIN BOOK. Here is assembled an amazing array of SETS, TUBES, SPEAKERS, REPLACEMENT PARTS, KITS, SHORTWAVE RECEIVERS and APPARATUS, AMPLIFIERS, LAFAYETTE RECEIVERS, TRITEST PARTS, PUBLIC ADDRESS, etc. ANYTHING AND EVERYTHING in Radio at the LOWEST WHOLESALE PRICES IN OUR HISTORY!

Wholesale Radio Service Co., Dept. SW43  
100 Sixth Avenue, New York

Please rush new free 1933 Catalog.

Name \_\_\_\_\_

Address \_\_\_\_\_

Town \_\_\_\_\_ State \_\_\_\_\_

## Short Wave Specials

### RESCO 3 RECEIVER

Using 1-32 Screen Grid and 2-30 tubes, constructed of quality parts throughout, aluminum chassis and panel, Vernier dial, range 15-200 M.

Assembled, Wired and Tested

**\$9.75** less tubes

#### SHORT WAVE BARGAINS

2 1/2 V. 8 amp. fil. trans. cased.....	\$1.69
Set of 4 short wave plug-in coils.....	1.79
Brandes head phones per pr.....	1.35
4" Bakelite dials.....	.15
3" Bakelite Vernier dials.....	.49
Bakelite coil forms ribbed.....	.19
Wafer Sockets 4, 5 or 6 prong.....	.06
Telegraph Keys.....	.89

All Merchandise Guaranteed

Radio Electric Service Co., Inc.

N.E. Cor. 7th & Arch Sts. Phila. Pa.

### FREE CATALOG

on one of the largest international connector lines for all short wave, broadcast, experimental and servicemen.

Write to

#### BANK'S INTER-AIR PRODUCTS

41-06 50th Street (SWC)  
Woodside, L. I., New York City

Coll-plugs shown, ideal for 5-meter work. 55 post takes all the plugs, plain Battery markings for short wave sets. 7 colors.

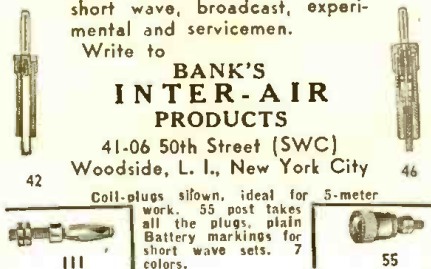

## Some Things You Don't Know About S-W Aerials

(Continued from page 715)

resistance to these minute R.F. currents and within 48 hours the corrosion will be so far advanced as to lower the efficiency of the antenna.

In the early days of radio, Saturday was antenna cleaning day. Several of the more enthusiastic would lower the antenna and polish the wires with steel wool. Steel wool was not pleasant to handle and a pair of old leather gloves was donned to prevent the fine particles of steel wool from entering the flesh of the hands.

Theoretically, the corrosion of copper wire, if sufficiently corroded, is just as good an insulator as an enameled coating. But too often the corrosion is unevenly distributed and, therefore, of uncertain effectiveness. Consequently, enameled covered wire is ideal for a short wave aerial.

Other coverings may be used, such as rubber, weatherproofing, paraffin cloth, cotton or silk, or any other covering of a good insulating quality.

The span of copper is all-important, the covering of the wire of secondary importance. The covering for portable aerial of station W6ZZA is a double layer of silk cloth woven over a large number of strands of carefully cut-to-size loop wire. Both the flat top portion and the feeder system use this kind of wire. One of the feeder wires is green silk covered loop wire, the other feeder is brown, making it easy to prevent the feeders from becoming entangled when the portable aerial is erected on a hotel roof after dark. This flexible loop wire is not as good as enameled wire but it permits of speedy installation and enables the operator to wind the antenna around the lid of a cigar box when it comes time to check out of the hotel.

It is repeated that solid copper wire is specified for short-wave aerials. Stranded wire offers more surface, lower resistance to the R.F. currents on the broadcast band. But it is not as good as solid wire for short-wave reception. This is because the higher frequencies (short waves) alternate so many times per second that certain losses are introduced when uneven-surfaced wire is used. The high frequencies tend to jump from wire to wire (stranded wire is twisted) rather than to follow the twists of the wire. Solid copper wire eliminates this "jumping" tendency, thus making an easier path for the flow of currents. Therefore, solid copper wire is recommended.

These details may seem commonplace and "finicky" to some. But it must be remembered that improvements and corrections in radio design multiply rapidly.

### A 2408% Increase in Efficiency

If we make a 2% improvement in the kind of antenna wire used, a 2% improvement in antenna insulation, a 2% improvement in antenna dimensions, a 2% improvement in antenna placement, a 2% improvement in antenna coupling to the receiver, a 2% reduction in noise pick-up, a 2% improvement in receiver coil design, a 2% improvement in the tuning condenser, a 2% improvement in the grid leak, a 2% improvement in the shielding, a 2% improvement in the placement of the receiver in its housing, a 2% improvement in the radio frequency choke coil, a 2% improvement in the tube and coil sockets and contacts, we will then have a total improvement of 2x2x2x2x2x2x2x2x2x2x2x2=2048%.

A 2% improvement in six of these places, or 2x2x2x2x2x2=32%, will not be perceptible to the human ear. Individually, these 2% improvements will result in no audible increase in volume, individually they are of no consequence. Collectively, the sum total of 2048% is what counts. This increase in efficiency will enable you to hear more stations from more countries, with more volume and with greater ease. It is evident, therefore, that

these little 2% increases, when multiplied, are of far-reaching importance in the total effectiveness of the completed receiver. Additional increases in efficiency are gained from the proper insulation of the antenna.

An antenna designed to deliver utmost performance at a certain frequency (wavelength) operates at peak efficiency only if tuned to its exact wavelength. At other wavelengths it does not deliver the same efficiency. Improper or poor insulation not only tends to distort the actual dimensions of the antenna but the antenna actually does not know where it terminates. Poor insulation is partly conductive. Thus the antenna has no definite terminating point. Like other things in radio, there is a difference of opinion as to the merit of various well-known insulating materials and the proper placement of the insulation. In practice we cannot resort to the last word in insulation because it is awkward, expensive and troublesome and the improvement which it offers over and above the accepted and commonplace method of insulation is not of sufficient importance to detract from the effectiveness of the properly designed all-around short-wave antenna system.

### Insulating Materials

The best insulating materials for antenna are silk, linen, cotton, or woven strands of these materials. They should be free from coloring because the base of all coloring is of a conductive nature. When silk, linen or cotton become wet the impurities in the material, plus the natural impurities in the air, introduce conductivity and a consequent lowering of the insulating qualities of the material. The quality of insulation can be preserved by boiling the material in vaseline. In time the sun will melt the vaseline and the useful life of our "perfect insulator" is from six months to one year.

Obviously, this perfect insulator is not practical and once more we resort to the time-worn radio compromise by using glass for antenna insulation.

Those who can afford to pay a little more for better insulators are advised to use PYREX. Good porcelain, finely grained, well baked and completely glazed, is the next best thing to use. Glass is the nearly perfect insulator and is an ideal compromise for short-wave antenna. Glass insulators can be procured from your parts supply house.

As a possible alternative a maple dowel stick can be used. It should be from 3/8" to 1/2" in diameter, one foot in length, boiled for an hour or two in paraffin. Like the vaseline-boiled linen insulator, these dowel sticks are at the mercy of the weather, dust and soot particles will accumulate on the dowel surface and the effectiveness of the insulator is then considerably reduced.

Portable W6ZZA uses cotton string for insulation. A ball of string is thrown over an elevator shaft or penthouse, hoisted to the top of a flag pole or attached to some other convenient support. Because the cotton string is used but once it is not affected by rain or moisture and a negligible amount of soot and dirt will accumulate on its surface. Cotton string makes a perfect short-wave antenna insulator, most convenient in its application, will retain its insulating qualities for an entire week. Given a quick jerk it will break easily and down comes the aerial. The aerial is then rolled over the lid of a cigar box and thrown into a suitcase when checking out of the hotel. But this cotton string insulation is intended for portable use only.

Glass, being our perfect compromise for a permanent antenna installation, can be had in the form of insulators 3" in length. The standard Pyrex Glass insulator is of that length. Longer glass insulators can be used.

**Remember-  
Only Nationally-  
Known Parts  
Used in All  
POWERTONE  
RECEIVERS**

# POWERTONE

**SHORT  
WAVE**

**WORLD RECEPTION**

**A.C. AND D.C.  
RECEIVERS**

**What more can any Short Wave Set offer?**

They are unsurpassable in construction and yet selling at such a ridiculously low price that anybody can now own one. Our huge purchasing power enables us to undersell all competitors. Just note the parts that comprise Powertone Receivers: **HAMMARLUND** tuning condensers; Special oversized Electrostatically shielded Power Transformers; Four new improved **POWERTEST** plug-in coils covering the wave length from 15 to 200 meters; Complete shielding which reduces di-electric losses to a minimum and assures maximum and uniform efficiency under all conditions; **LYNCH** color-coded **R.M.A.** resistors used throughout the entire construction.

The hinged top facilitates removing of tubes and coils. The large **SLOW-MOTION** Tuning Dial is an exclusive Powertone feature. You will be proud to own a Powertone Receiver with its rich-looking finely constructed cabinet.



A. C. MODELS	
3-Tube AC wired... \$14.95	4-Tube AC wired... \$19.75
Kit of parts... 12.75	Kit of parts... 16.95
Tubes (56, 57, 80)..... 2.35	Tubes (58, 58, 56, 59, 80)..... 2.95

BATTERY OPERATED SETS	
2-Tube wired \$9.95	3-Tube wired... \$12.95
Kit of parts... 7.95	Kit of parts... 10.75
Tubes (232, 233)..... 1.50	Tubes (34, 2-30)..... 2.15

**Stromberg-Carlson No. 3A Phonograph Pick-up**  
Consists of built-in volume control, special impedance matching transformer, 20 ft. extension cord and bakelite plug. Sells at \$30.00. **NETS**. We carry an enormous quantity of Stromberg-Carlson Pick-ups in stock. Immediate shipment upon receipt of order in your hand. **\$6.25**

**R.C.A. Victor Hellogg Hand Mike "Super Special"**  
Not a Toy! Single Button Carbon Microphone. **\$1.10**

**Farand Inductor Dynamic Speaker**—12 in. model. A real buy at **\$2.95**

**9 in. model**..... **\$2.95**

**3 Stage 250 Push-Pull Amplifier**—Uses 27, 24, 2-81, 2-50 Tubes. Guaranteed Performance. As regards (Real Value)..... **\$19.95**

**fresh 45-Volt B Batteries** at this new low price... **79c**

**2 1/2-Volt Filament Transformer**, 8 amp. **95c**

**Midget Power Transformer**—110-115 volt primary. High voltage 700 e.t. (350-350) 5 volts for 80 rectifier tube. 2 1/2 volt winding at 4 amp. **95c**

**Sangamo Push-Pull In-Put and Out-Put Transformers**..... **\$1.25 ea.**, **\$2.50 per set**

**Standoff Insulators** With hardware..... **50c doz.**

**Microphone Floor Stands**—Weight, 12 lbs. **12.00** from 40" to 72"..... **\$3.95**

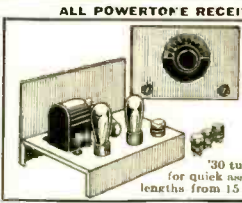

**Two Tube RELIABLE Short Wave Receiver Kit**  
Comprised of the finest parts—**HAMMARLUND** Condensers, Carter Rheostat and switch, **KURZ-KASCH** Vernier Dial, **HAMMARLUND** Equalizer Antenna Condenser, are some of the well-known parts. Panels and Chassis drilled. Everything needed to build a corking 2-tube battery operated short wave receiver that **REALLY WORKS**. Uses two 30 tubes. A blueprint and instructions with kit for quick assembling. 1 set of four coils covering wave lengths from 15 to 200 meters included in kit..... **\$4.50**

**New Beede D'Arsonval Movement Instruments**

0-1 mill..... \$4.12	0-100 mill..... \$3.25
0-5 mill..... 3.25	0-200 mill..... 3.25
0-25 mill..... 3.25	0-500 mill..... 3.25
0-50 mill..... 3.25	0-1000 mill..... 3.25

**Duallier & Mid. Electrolytic Condensers**—dry 45c

**Lightweight Head Phones**..... 95c

**Walter Sockets** 4, 5 or 6 phones..... 6c each, 60c doz.

**Ely Modified Bakelite Sockets** 4 or 5 prong..... 12c

6 prong..... 15c

**K. K. Dials** 3 and 4 inch..... 49c

**Microphone Transformer** single or double button..... \$1.30

..... 25c

**20 Ft. Extension Cord with Connector**..... 20c

**30 ft.**..... 29c

**Centralab** 10,000, 25,000, 50,000, 100,000, 500,000 ohm potentiometers..... 39c with switch..... 49c

**Weston & Jewell** (slightly used) **No. 301**, **No. 88** and **No. 476** Volt-mill and Thermo Meters..... 60% off list

**R. C. A. 50 watt Tubes**..... \$45.00

**Plug-in coil forms** (color coded)..... 12c ea.

**TRY-MO RADIO CO., Inc. Dept. S4**  
**85 CORTLAND STREET (MAIN STORE)**  
**179 Greenwich St. (cor. Dey St.)**  
**179 Greenwich St. (nr. Cortland St.) New York City**

Send for our 68-page Two-Color Catalog. "We don't send circulars, only Catalogs."

20% deposit must accompany C.O.D. orders. If check, kindly certify to insure prompt delivery.

Rope should be used for hoisting the antenna. Cotton rope is a better insulator than hemp. Do not use wire. It picks up noises from nearby wiring. The rope hoist is attached to the insulators on each end of the antenna. Real enthusiasts can boil this rope in vaseline, thereby weather-proofing the rope and preventing it from contracting and expanding with changes in humidity.

The hoist rope usually runs through a pulley, attached to a pole on the house or in a vacant lot. Do not fasten the rope to the base of the pole. Tie a window sash weight to the end of the rope, thus permitting the rope to contract several feet during a heavy rain or fog. The weights "go up the pole" as the rope contracts. The pole will not bend, the rope will not break, and there is less wear and tear than when the rope is attached to the base of the pole. Window sash weights can be obtained from any hardware dealer. They are good looking. The weights used at the Wallace station for holding a 612' antenna taut, are the 34-pound size. By using these weights the top of the pole is never subjected to a strain of more than 34 pounds.

**Placement of the Antenna**

An antenna to be most effective must be in the clear. The placement of the antenna is of utmost importance. It should be as high as possible, not too close to the houses or other large objects, as far removed from lightning circuits and telephone lines as possible. Too often such an ideal condition cannot be found for the erection of the average antenna.

**Transposition Blocks**

Transposition blocks for the antenna feeders can be made from various insulating material. Bakelite is cheapest, can be purchased in suitable block form, as shown in the illustration. Porcelain blocks are better than those made from Bakelite.

The feed lines are transposed by means of these blocks. Cancellation takes place throughout the length of the feed lines where insulation is not quite as important as in the antenna proper.

The ideal transposition blocks for short waves would be those of glazed porcelain. To ascertain the correct dimensions of an antenna the use of a half wave is resorted to; the figure 1.56x the wavelength. Because of the size of the antenna wire used, capacity to earth and various other corrections, it is not possible to use the straight meter system and transpose it into feet and expect to find the wavelength of the antenna proper. The figure 1.56 is accepted as an average, being the result of a large number of tests made from antennas which have been carefully tuned by means of oscillators. Inasmuch as the amateur short-wave bands are in harmonic relation with each other, the antenna sizes can be selected with regard to their convenience. The two most widely used short-wave broadcast bands are not in harmonic relation to each other. It therefore becomes necessary to adopt the 26 or 49 meter band as a standard. However, we also want to hear all of the other stations.

The transposition blocks should be spaced from 15 inches to 36 inches apart. A space of 2 feet between blocks seems to be the accepted compromise. The exact size of the transposition blocks is not important. Any size, from 1" square to 8" square will suffice. The larger blocks must be spaced far apart, the smaller blocks close together. Large blocks offer added resistance to wind pressure. Small blocks are more suitable for general requirements.

Determine the proper size of the antenna by measuring the wires with a tape or yardstick. Stretch the enameled antenna and feeder wires. It is not necessary to cut the antenna wires where they meet the feeder wires. Reeve the antenna wires through the glass insulator in the

center of the antenna and continue these for use as feeders. Fasten the aerial wires to the insulators with short pieces of wire, made into the form of a loop and soldered, thereby insuring a "definite ending," as explained previously in this article. (Courtesy "RADIO.")

**Short Wave League**

(Continued from page 737)

like it let's hear about it. One more shot and I'll shut up. There is one regulation that should be changed and that is the one making the operator guilty of the same offense when he talks to a W9? He should be allowed to talk to the unlicensed station and get his QRA and report it to FRC. A good ham stays off till he gets his paper. Don't get me wrong; I'm 100% for the SHORT WAVE LEAGUE and SHORT WAVE CRAFT.

78's and CuL.  
C. E. Mullendore,  
2620 Y St., Lincoln, Neb.

**Editor, SHORT WAVE CRAFT:**  
I have been a reader of your fine magazine at news stands for past year and think that it is the very best Short-Wave magazine going.

I noticed that the SHORT WAVE LEAGUE is trying to do away with code requirements for the ultra-short wave phone band. I do not think that this is necessary; anyone that is interested in radio communication of any kind should also be interested enough to spend a little time and learn the code.

Wishing your magazine the best of luck.  
Yours truly,  
M. L. Nielsen,  
Amateur Radio W9FNX,  
Rock Rapids, Iowa.

**NOW READY**  
**1933 CHI-RAD SHORT WAVE CATALOG**

**NEW, LOWER PRICES on the Most Complete Stock of Short Wave Parts Ever Offered**

This big loose-leaf book is "just what the doctor ordered for Short-Wave enthusiasts!" Page after page of parts, replacement units, etc., difficult to find elsewhere. And all at rock-bottom 1933 wholesale prices. Get the New 1933 loose-leaf CHI-RAD Catalog and find real satisfaction, service, and savings. It's more convenient, too, to order everything you need from one place, conserving time, shipping costs, and the trouble of shopping around. Don't delay—send 10c for this big book TODAY!

**CHICAGO RADIO APPARATUS CO.**  
 Established 1921  
 415 S. Dearborn St., Dept. S43, Chicago, Ill.

Chicago Radio Apparatus Co.,  
 415 S. Dearborn St., Dept. S-43  
 Chicago, Ill.

Enclosed find 10c for a copy of your New, loose-leaf 1933 Catalog.

Name \_\_\_\_\_  
 Address \_\_\_\_\_  
 Town \_\_\_\_\_ State \_\_\_\_\_



Send for our new 1933 Catalog. Just off the press. Everything in replacement parts, Tubes, Batteries, Latest Sound Systems, Automobile Sets and Electrical Supplies. 6000 items at lowest wholesale prices. Prompt, reliable service. Send for this big FREE Catalog today. You need it.

**ALLIED RADIO CORP.**  
 837 W. Jackson Blvd., CHICAGO, ILLINOIS

**PATENTS—TRADE MARKS**  
 All cases submitted given personal attention by members of the firm.  
 Information and booklet free  
**LANCASTER, ALLWINE & ROMMEL**  
 PATENT LAW OFFICES  
 Suite 434 815-15th St. N. W., Washington, D. C.

**DO IT NOW**  
**PATENT Z. H. POLACHEK**  
 YOUR IDEAS REGISTER YOUR TRADE-MARK BY 1234 BROADWAY 31st. NEW YORK  
 REG. PATENT ATTORNEY PROF. ENGINEER  
 WHAT IS YOUR INVENTION?  
 Send me a simple sketch or model for CONFIDENTIAL ADVICE

**Members SHORT WAVE LEAGUE**  
 Read Page 708

**The Lincoln R-9:A New 9 to 200 Meter Super-Het**

(Continued from page 729)

volume control is had by controlling the complete I. F. amplifier. This feature can be eliminated and the set will work without A.V.C. by manipulating a switch on the front panel.

**"C.W." Reception Provided for**

A beat oscillator is employed for reception of "C.W." signals; this is also operated by a switch on the front panel. Full indication of signal is had with the meter mounted in the center of panel, allowing accurate tuning to the exact center of the carrier wave and also indicating unmodulated carriers which can be tuned with perfect accuracy. This valuable feature is of paramount importance, as many stations are "standing by" temporarily and would be entirely overlooked without this method of location.

Two dials are employed, the one to the left being the main tuning dial and the one to the right for band-spreading, which is effective on all frequencies. In commercial work, where the operator only works a specified band of frequencies, this band-spread dial is very desirable, allowing wide separation on the dial.

**Sensitivity and Volume Controls**

The regulation of sensitivity and volume is identical with the Lincoln DeLux SW-33, and it is one of the most satisfactory systems for the broadcast listener as well as the commercial operator. In order to get distance in the conventional type of receiver, one is required to advance the sensitivity control to a point where heavy noise and signal can be heard loud enough to disturb the whole neighborhood; while in the new Lincoln system, the sensitivity control can be advanced to a maximum, giving power to reach any distance and the volume control can be at minimum, with speaker volume only loud enough to be heard a few feet away from the speaker. This system also allows absolutely silent tuning by the use of the signal indicator.

The R-9 model is of the table mounting type, having a heavy metal removable cover and heavy metal front panel. The chassis is mounted on a wood base with moulding at bottom, and the whole unit is attractively finished.

A separate power pack is used, identical with the large DeLux all-wave model, together with a dynamic speaker. A head phone jack is incorporated.

**Great Volume Available**

The tremendous amplification and the undistorted volume possible in both the R-9 and the DeLux model brings weak signals up to tremendous output volume if desired. The Lincoln laboratory happens to be located practically in the center of the largest medical area in the United States, composed of hospitals and medical schools, with a terrific barrage of diathermy, X-ray and other high frequency equipment. Yet, in spite of this interference, signals from foreign stations are brought in with any desired volume, and all equipment is tested directly on these signals.

**Don't Miss Part II of the New Revised S-W STATION LIST in the Next Issue**

**Amateurs who made good**

**William Green**

● ANOTHER prominent example of the invaluable aid of the practical experience gained by operating an amateur station in achieving a position of importance in the radio industry, is furnished by the outstanding career of Mr. Green. At present design engineer of the Royal Short Wave & Television Co., he has been successfully linked with the radio industry for a number of years.



William Green

No farther back than 1918 he became interested in radio development. Advancing in successive stages from experimenter and custom set builder to technician and finally engineer, his rapid rise in radio has merited the attention of all.

During his connection with the Royal Short Wave & Television Co., Mr. Green has developed in the laboratory a new and very efficient means of coupling a screen-grid detector to a succeeding stage. This coupler has been since given the name "Trans-X" unit. As a result of his untiring research, he engineered this device to a goal.

Among other achievements he has brought forth in his present affiliation a complete line of all-electric short-wave receivers that are free of all hum, and a series of economical battery-operated S.W. sets, are notable.

As consultant he has been associated with several radio concerns. Since 1929, the Harrison Radio Co. of New York has enjoyed his confidence in this respect in all technical matters.

Mr. Green has been an amateur for years under the call letters 2AEL. He now owns and operates station W2DXC.

**Dolling Up the "Go-Getter"**

(Continued from page 725)

- C3—Fixed condenser .006 mf. See text.
  - C4—Fixed condenser .002 mf.
  - C5—By-pass condenser 1 mf.
  - C6—By-pass condenser .1 mf.
  - C7—Midget condenser, Pilot, 7 plate type.
  - R1—Filament rheostat, 20 ohms.
  - R2—Grid leak 5 megohms.
  - R3—Pilot Resistograd or any 0—500,000 ohm variable resistor.
  - R4—Grid leak type resistor, 10,000 ohms.
  - A.F.T.—3½-1 audio transformer, Pilot.
  - VT1—Type 32 screen grid tube.
  - VT2—Type 30 battery tube.
  - VT3—Type 33 battery pentode.
  - L1 and L2—Tube base plug in coils as follows:
- | Band   | Turns on L1 | Turns on L2 |
|--------|-------------|-------------|
| 10-20  | 5           | 3           |
| 20-30  | 6           | 5¼          |
| 30-40  | 6           | 8           |
| 40-80  | 10          | 14¼         |
| 80-100 | 10          | 29          |

**Additional Parts Necessary, Not Shown:**  
 5 UX tube bases.  
 3 UX type sockets, Pilot.  
 1 UY type socket.  
 7"x14" bakelite panel.  
 Vernier dial.  
 Binding posts, wire, solder, etc.



# A New Form of Tuning Inductance

(Continued from page 734)

the coil L (but not connected metallically to it). Variations in the proximity of this plate to the coil will cause changes in the distributed constants of the coil which will in turn vary the electrical length or fundamental frequency of the aerial. The closer plate P comes to coil L the longer the wavelength and vice versa.

The metal plate can be directly connected to the grid of a tube or through a coupling condenser. Because the coupling with this system is always electrostatic, i.e., capacitive, the sensitivity of the grid circuit into which it is working or connected will not be noticeably disturbed and the receiver will always be operating at maximum efficiency. However, due to the extreme sharpness of tuning in the wave-conductor, unless its frequency is accurately tuned to the grid circuit reception will be poor. This is not a disadvantage since with this system stations which cannot be separated with the ordinary tuning condenser can be easily separated by tuning the antenna circuit.

Since any aerial, whether of the half-wave (ungrounded) or quarter-wave (one end grounded) will be resonant to not only its fundamental frequency but also to frequencies 2-3-4- etc. times the fundamental, tuning can be accomplished through a wide range of frequencies without changing the wave-conductor proper. That is, if a wave-conductor with a given aerial will tune from 80 to 40 meters by varying the plate P, it will also be resonant (but not nearly as sharply) to wavelength ranges  $\frac{1}{2}$ - $\frac{1}{4}$ - etc. of 80-40 meters or 40-20, 20-10, 10-5, etc. meters. For this reason the wave-conductor cannot in itself be used for the main tuning control. Although it is sharply tuned to a station on say 70 meters, it would also be tuned to any station which might be operating on 35-23.3-17.5- etc. meters, with decreasing sharpness as the

wavelength is reduced. Why this is true can be seen from a study of Fig 2-C. As the frequency is increased above that of the fundamental the number of maximum voltage peaks is increased and because of their various phases tend to neutralize each other, resulting in decreased signal strength and selectivity. Consequently, it is necessary for the regular tuning condensers of the receiver to differentiate between these multiple frequency stations.

### Design and Construction of Wave-Conductor

The construction of a wave-conductor of this type is very simple. The number of turns is not at all critical, because of the 2-3-4- etc. frequencies which the system will tune. If a coil is wound with about 30 turns on a one inch form and the winding closely spaced, it will be found quite sufficient to cover frequencies from about 3000 to 30,000 kc. The plate P should be flat and mounted at only one end on some hinge arrangement and equipped with a screw drive of some kind for accurate tuning. The size of this plate is about the same as that of the perimeter of the coil winding. It is of course evident from a study of Fig. 2 that aeriols of different lengths will change the dial setting on the wave-conductor. The coil described will work satisfactorily with the average short-wave aerial of about 40 feet or so.

If it is desirable to construct wave-conductors to operate at any particular fundamental frequency range the number of turns should be about twice that required to tune the same frequency range with a given variable condenser.

*In very sensitive receivers the wave-conductor and the connecting lead to the set should be shielded to prevent direct pickup of energy from the aerial.*

# The Cigar-Box 1-Tube "Catch All"

(Continued from page 716)

store.

If no inductance switch is available, a small spring clip, to clip to the taps, will do just as well and also eliminate a control from the panel.

Parts used, with values, follow:

- 3 $\frac{1}{2}$ " length of 1 $\frac{1}{2}$ " diameter tubing—flash-light fibre tube used.
- 55 turns of No. 28 D. C. C. wire, tapped at 7th, 15th and 25th turns.
- 1 23 plate Pilot midget condenser. (.0001 mf. maximum.)
- 1 20 ohm rheostat.
- 1 filament-control jack. Yaxley.
- 2 grid-leak clips, used for holding "A" battery.
- 2 pin jacks for aerial and ground connections.
- 1 10 megohm grid-leak. (Lynch or International)
- 1 .0001 mf. grid condenser.
- 1 type 30 tube.
- 1 4-prong tube socket.
- 7 midget flat-type flash-light cells, for

"B" battery.

- 2 No. 2 flash-light cells for "A" battery.
- 22 ft. of No. 28 D. C. C. wire.
- 5 ft. of No. 30 D. C. C. wire for tickler.
- 1 roll of Braidite hook-up wire.
- Wood for case,  $\frac{1}{4}$ " thickness.
- 3 ply veneer for sides. (I used birdseye maple.)
- Hinges, clasp, glue, etc.
- 1 burned-out tube base. Wind on 15 turns of No. 30 D. C. C. wire and be sure to wind in same direction as main inductance tube.
- 1 10/32 threaded rod, any size available will do. Ream hole in center of tube base so that rod will turn freely. Bring out two tickler terminals and solder on spirals of heavier wire to lead out through end of inductance tube. By winding wire on a lead pencil you can make the spiral which acts like a spring as the tickler slides up and down in the inductance tube and will not break.

# Book Review

SHORT WAVE WIRELESS COMMUNICATION, by A. W. Ladner and C. R. Stoner. Size 5 $\frac{1}{4}$ "x8 $\frac{3}{4}$ ", cloth bound. 348 pages, 200 illustrations. Published 1933 by John Wiley & Sons, Inc., New York, N. Y. Price \$3.50.

● THERE has been a distinct need for some time for a good text book written by engineers who could explain in clear English with suitable diagrams, what every student of "short waves" want to know and Messrs. Ladner and Stoner who have had many years experience with

Marconi's Wireless Telegraph Company in London here provide a very readable book. Some of the subjects covered are: Development of short waves; the propagation of electro-magnetic waves; modulation of high frequency waves; "push-pull"—and what it does; high frequency transmitting circuits; short-wave driven-circuits; constant frequency oscillators; high frequency feeders and aerial arrays; problems of reception and a description of commercial S-W receivers. The book closes with a dandy chapter on ultra short waves, which are clearly explained with diagrams and photos. The book is well indexed and has a valuable appendix.

# St. Charles

An Entire Block  
On the Boardwalk

ATLANTIC CITY



A Smart Hotel in  
America's Smartest Resort

Atlantic City—Healthful—Restful—Affording complete relaxation so welcome after intensive work—Where the St. Charles offers the maximum in hotel comforts and service—Spacious Sun-Deck—occupying one entire block—Overlooking Boardwalk and Sea—Ocean View Lounge—High standard of French and German Cuisine. Garage.

European or American Plan  
Rates Greatly Reduced

Makes Your Radio BEHAVE!

Install AMPERITE—the voltage regulator recommended by leading manufacturers. Stops burnouts and crackling noises. There's an AMPERITE replacement regulator for every make of radio.

Send \$1.40 to Dept. SW-4 for sample, sales helps and exclusive territory.



AMPERITE Corporation  
561 BROADWAY, NEW YORK  
**AMPERITE**  
VOLTAGE CONTROL

## Get Started in RADIO



Write for free booklet telling about this growing and most promising industry. Resident courses in  
RADIO OPERATING  
RADIO SERVICING  
EDUCATIONAL DEPARTMENT  
WEST SIDE YMCA 18 W. 63rd St. New York

## PATENTS TRADE MARKS COPYRIGHTS

"Little Ideas May Have Big Commercial Possibilities" PROTECT THEM BY PATENTS

Send for our Free book, "How to Obtain a Patent" and "Record of Invention" blank. Prompt Service—Reasonable Charges—Deferred Payments  
HIGHEST REFERENCES

**VICTOR J. EVANS & CO.**  
Registered Patent Attorneys—Established 1898  
651DD VICTOR BUILDING WASHINGTON, D. C.

# WORLD'S BEST RADIO BOOKS

IT IS always the well-trained man who wins out over the horde of thousands of superficially trained and incompetent men. You are reading this magazine because you are interested in radio. Sooner or later, the time will come when you will wish to cash in on your knowledge. Your chance may come over night, and then the big and vital question will be, "How well equipped am I to fill the job?" You are in radio because you like it. You also realize that, at the present time, there are many branches of the radio art which you do not know as thoroughly as you should. Knowledge, these days, can be gotten cheaper than ever before. It isn't necessary for you to go to college to become proficient in radio. Start today, to build a REAL radio library and become acquainted with all branches of this great and growing art. In this page are listed the world's best radio books. We have combed the market for the really important books in radio; so that, no matter what branch you are interested in, you can pick out the best books that are now printed. Start, now, to build a complete radio library. You do not have to get all the books at once, but make up your mind to get one book a month; so that, when your chance comes, you will be fully equipped to win out over the others not so well equipped.

**IMPORTANT.—This list is changed every month to include the latest books. Note also new low prices.**

**THE RADIO HANDBOOK**, by James A. Moyer and John F. Westrel. Flexible covers, size 5 1/2 x 8 1/2", 886 pages, 650 illustrations. Price **\$5.00**

Comprehensive data on short-wave apparatus, vacuum tubes, modern radio receivers and transmitters, photoelectric cells, television, sound motion pictures, tables, graphs, diagrams, etc. No radio man should miss it.

**RADIO FREQUENCY ELECTRICAL REQUIREMENTS**, by Hugh A. Brown. Cloth covers, size 6 1/2 x 9", 386 pages, 235 illustrations. Price **\$4.00**

One of the few great books on this important subject. Everything from thermionic-tube coefficients to piezo-electric measurements.

**PRACTICAL TELEVISION**, by E. T. Lerner. Cloth covers, size 5 1/2 x 8 1/2", 223 pages, 127 illustrations. Price **\$3.75**

This book explains television in full, including elementary principles, photo-electric cells, and all important types of television sets as well as basic principles of optics, images, mirrors, lenses, etc.

**MAGNETIC PHENOMENA**, by Samuel Robinson Williams. Cloth covers, size 6 1/2 x 9", 230 pages, 150 illustrations, and numerous tables. Price **\$3.00**

All electric motors, coupling coils, magnetic and dynamic loud speakers, transformers, choke coils, etc., are dependent on magnetic phenomena. This fine book is complete on the subject.

**CINEMATOGRAPHY**, by James R. Cameron. Stiff covers, size 7 1/2 x 9 1/2", 240 pages, 150 illustrations. Price **\$4.00**

Everything on the subject from "silent" and "talkie" 16 mm. film to its manufacture and to the final projection is in this marvelous volume.

**AUDELS RADIOMAN'S GUIDE**, by Frank D. Graham. Cloth covers (flexible), size 5 1/2 x 8 1/2", 220 pages, 300 illustrations. Price **\$1.00**

A practical, concise book presenting the theoretical and practical information for the proper operation, maintenance and service as applied to modern radio practice.

**THE RADIO AMATEUR'S HANDBOOK** (New Revised Edition), by A. Frederick Collins. Cloth covers, size 5 1/2 x 8 1/2", 394 pages, 116 illustrations. Price **\$2.00**

If you wish to become a radio amateur (radio ham) this book tells you how. Everything in receiving and transmitter sets and how to build them.

**EXPERIMENTAL RADIO**, by R. R. Ramsey, Prof. of Physics, Indiana University. Cloth covers, size 7 1/2 x 9 1/2", 256 pages, 168 illustrations. Price **\$2.75**

A marvelous book for the experimenter. Experiments galore in easy comprehensible language.

## HOW TO ORDER

We cannot ship C. O. D. Our prices are net, as shown. Some of the books sent prepaid (in U. S. only). Those that are not thus listed will be shipped by express collect if sufficient postage is not included by you.

**FOUNDATIONS OF RADIO**, by Rudolph L. Duncan. Cloth covers, size 5 1/2 x 8 1/2", 246 pages, 145 illustrations. Numerous tables. Price **\$2.50**

This textbook gives you the fundamentals of electricity as applied to radio. It equips you for further study in the field of radio.

**RADIO THEORY AND OPERATING**, by M. T. Loomis, 5th revised Edition. Cloth-bound; size 5 1/2 x 8 1/2" thick; 1,000 pages; over 800 illus.; 450 review questions and answers. Price **\$4.50**

Written in textbook style, a tremendous amount of useful information has been crammed into this thin-paper, compact reference work. Radio transmission and reception have been covered, "from soup to nuts." A truly great book.

**9. GERNSBACK'S RADIO ENCYCLOPEDIA** (Second Edition). Red Morocco Flexible Binder, 352 pages, 2201 radio definitions, 1253 illustrations, 34 tables. Price **\$3.25**

The most comprehensive encyclopedia of its kind in print. Remarkably up-to-date in every way, with marvelous illustrations.

**DRAKE'S CYCLOPEDIA OF RADIO AND ELECTRONICS**, by H. P. Manly. Cloth covers, size 6 1/2 x 9", 1050 pages, 1080 illustrations. New 1932 Edition. Price **\$5.00**

The largest work of its kind ever put between two covers. New and up-to-date; a standby for every radio man.

**FUNDAMENTALS OF RADIO**, by H. R. Ramsey, Professor of Physics, Indiana University. Cloth covers, size 9 1/2 x 6", 372 pages, illustrated. Price prepaid **\$3.50**

The backbone of the radio art. This book gives you the foundation on radio from A to Z.

**RADIO OPERATING QUESTIONS AND ANSWERS**, by Nilsson and Hornum. Fourth Edition. Cloth covers, size 5 1/2 x 8 1/2", 350 pages, 131 illustrations. Price **\$2.50**

Contains over 600 questions and answers covering all phases of licensed radio operation. Revised to contain much new material. Nothing better in print for the transmitting and receiving amateur.

**OFFICIAL RADIO SERVICE MANUAL**, Volume I, by Hugo Gernsback and Clyde Fitch. Flexible loose-leaf binder, size 9 1/2 x 12", over 2,000 illustrations, 850 pages. **COMPLETE WITH SIX SUPPLEMENTS.** Price prepaid **\$4.50**

The Service Man's Bible. Greatest book ever published on the subject. Contains all old circuits of every imaginable commercial radio set up to 1931.

**THE RADIO MANUAL**, by George E. Sterling and Robert S. Kruse, E. E. 2nd enlarged edition. Flexible tabloid covers. Size 5 1/2 x 8 1/2", 805 pages, 348 illustrations. Price **\$6.00**

A complete Radio Course for the operator, the technician, the amateur, the student and experimenter. Everything imaginable in the whole radio art is covered in this great book—the "radio Bible" of the amateur. **DON'T MISS THIS.**

**EXPERIMENTAL RADIO ENGINEERING**, by John H. Morecroft. Cloth covers, size 6 1/2 x 9", 346 pages, 250 illustrations. Price **\$3.50**

A student's book; devoted to the principles of radio apparatus; intended to accompany a course in electricity. The best of its kind.

**PRACTICAL RADIO CONSTRUCTION AND REPAIRING**, by J. A. Moyer, S.B., A.M. and J. F. Westrel. Cloth covers, size 8 1/2 x 11 1/2", 163 pages, 163 illustrations. Price **\$2.50**

A handbook that every radio set tester and general student must have. The diagrams alone are worth the price of the book.

**A POPULAR GUIDE TO RADIO**, by H. Francis Dashiell. Cloth covers, size 5 1/2 x 8 1/2", 288 pages, profusely illustrated. Price prepaid **\$3.50**

The fundamental principles of radio. From crystal rectifiers to the latest electron tube amplification, etc.

**PRINCIPLES OF RADIO COMMUNICATION**, by J. H. Morecroft, Prof. of Electrical Engineering, Columbia University. Cloth covers, size 9 1/2 x 6", 988 pages, profusely illustrated. Price **\$7.50**

The radio classic, by the dean of radio. Covers entire radio art as does no other book.

We herewith present the most complete collection of recent important radio books. We have, after an exhaustive study, selected these volumes because they represent the foremost radio books of their kind in print today. There is such a great variety that we are sure it will satisfy any taste as well as any requirement that the student of radio might have. We publish no catalog and ask you to be kind enough to order direct from this page. Prompt shipments will be made to you direct from the publishers. We merely act as a clearing house for a number of radio publishers and **OUR PRICES ARE AS LOW OR LOWER THAN WILL BE FOUND ANYWHERE.** Remit by money order or certified check. If you send cash, be sure to register it.

**SHORT WAVES**, by C. R. Leutz and R. B. Gable. Stiff covers. Size 6 1/2 x 9", 384 pages, 258 illustrations. Price **\$3.00**

The biggest and most complete book on short waves. Covers every imaginable phase, including S. W. Superheterodynes. The authors are famous S. W. authorities.

**SOUND PICTURES AND TROUBLE SHOOTERS MANUAL**, by Cameron and Kilder. Cloth cover, size 8 1/2 x 11", 1120 pages, profusely illustrated. Price **\$7.50**

The standby of every operator. It is the most thorough book on the subject.

**ELECTRICITY AT HIGH PRESSURES AND FREQUENCIES**, by Henry L. Transtrom. Cloth covers, size 7 1/2 x 9 1/2", 248 pages, 141 illustrations. Price prepaid **\$2.35**

A marvelous book for the student in electricity and radio. General fundamentals lead up to a complete discussion of every type of Tesla and Oudin high-frequency coils, Geissler tubes, etc.; construction details of Tesla coils are given in great profusion. **THE ONLY BOOK OF ITS KIND.**

**OFFICIAL RADIO SERVICE MANUAL**, Volume II, by Hugo Gernsback, C. E. Denton and C. H. W. Nason, with 1932 Free Supplements, 1000 pages, 2000 illustrations. Flexible loose-leaf binder, size 9 1/2 x 12". Price prepaid **\$4.00**

The talk of the radio industry. This marvelous volume contains every thing in radio, circuits and radio developments, for 1932. Not a line of duplication between 1931 and 1932 volumes. (Vol. I and Vol. 2.)

**ORDER DIRECT FROM THIS PAGE**

**ELEMENTS OF RADIO COMMUNICATION**, by Professor John H. Morecroft. Cloth covers, size 8 1/2 x 11 1/2", 270 pages, 170 pages, 163 illustrations. Price **\$3.00**

An authoritative volume embracing every imaginable phase in radio communication.

**RADIO SERVICE MAN'S HANDBOOK WITH ADDENDA DATA SHEETS**. Flexible covers, size 9 1/2 x 12", 200 pages, 400 illustrations. Price prepaid **\$1.49**

The Service Man's standby. Contains the latest practical information on radio servicing.

**HOW TO PASS U. S. GOVERNMENT RADIO LICENSE EXAMINATIONS**, by R. L. Duncan and C. E. Drew. Flexible covers, size 9 1/2 x 7", 170 pages, 92 illustrations. Price **\$2.00**

The most important book on the subject ever published. Gives every conceivable angle which will help you to pass a radio license examination successfully.

**RADIO RECEIVING TUBES**, by Moyer and Westrel. Cloth covers, size 7 1/2 x 9 1/2", 298 pages, 181 illustrations. Price **\$2.50**

One of the finest books on vacuum tubes. Everything worthwhile on the subject treated in a masterful manner.

**RADIO TELEGRAPHY AND TELEPHONY**, by R. L. Duncan and C. E. Drew (New Edition). Cloth covers, size 9 1/2 x 6", 950 pages, 468 illustrations. Price **\$7.50**

Everything from Ohms Law to vacuum tubes and detectors, to oscilloscopes and radio compasses thoroughly treated in this great book.

**PHOTOELECTRIC PHENOMENA**, by Arthur Llewellyn Hughes and Lee Alvin Durrbridge. Cloth covers, size 6 1/2 x 9 1/2", 531 pages, 202 illustrations. Price **\$5.00**

A critical survey of the whole field of photoelectric phenomena, intended as a reference book for research workers, students and teachers. The most complete work in print.

**RADIO SERVICING COURSE**, by Ghirardi and Freed. Cloth covers, size 5 1/2 x 7 1/2", 192 pages, 124 illustrations; 114 test questions; 28 test-instrument circuit. Price **\$1.50**

A practical book beginners and old-timers in radio service will find useful. Nine chapters discuss measuring instruments and tests, and trouble-shooting; the chapter, "Useful Information for Servicemen," closes the book.

**EXPERIMENTAL TELEVISION**, by A. Frederick Collins. Cloth covers, size 8 1/2 x 11 1/2", 312 pages, 188 illustrations. Price **\$2.50**

In words of one syllable the author discusses fundamental principles; in the same vein he proceeds to build up descriptions of television equipment, each step being supported by simple, home-made experimental set-ups.

**RADIO MOVIES AND TELEVISION**, by C. Francis Jenkins. Cloth covers, size 9 1/2 x 6", 144 pages, profusely illus.-treated. Price **\$1.00**

A complete volume by the master of television, giving everything in television, including constructional details for building your own television sets.

**RADIO PHYSICS COURSE** (2nd enlarged edition), by Alfred A. Ghirardi. Cloth covers, size 7 1/2 x 9 1/2", 992 pages, 510 illustrations, numerous tables. Price **\$3.50**

The finest and most popular book on electricity and radio. Each subject is clearly discussed, with the aid of dozens of excellent drawings. Chapters on talks, television, electronics and service work, etc. Biggest buy in radio books.

**RADIO VISION**, by C. Francis Jenkins. Cloth covers, size 9 1/2 x 6", 144 pages, profusely illustrated. Price prepaid **90c**

An excellent book. The Jenkins television system, as well as many other modern television systems fully described.

**PRINCIPLES OF RADIO**, by Keith Henney, M. A. Cloth covers, size 8 1/2 x 6", 478 pages, 306 illustrations. Price **\$3.50**

A marvelously written textbook with the latest radio principles, including screen grid and pentode, amplifiers, etc.

**NEW LOW PRICE RADIO BOOKS**

Here are 13 new, up-to-date books on every conceivable radio subject, just published. Modern in every sense. **ALL BOOKS UNIFORM** from 64 to 72 pages; 50 to 120 illustrations. All books written by well-known radio authors. Order by Number.

No. 1 **RADIO SET ANALYZERS**, by L. Van Der Mel

No. 2 **MODERN RADIO VACUUM TUBES**, by Robert Hertzberg

No. 3 **THE SUPERHETERODYNE BOOK**, by Clyde Fitch

No. 4 **MODERN RADIO HOOK-UPS**, by R. D. Washburne

No. 5 **HOW TO BECOME A RADIO SERVICE MAN**, by Louis Martin

No. 6 **BRINGING ELECTRIC (RADIO) SETS UP TO DATE**, by Clifford E. Denton

No. 7 **RADIO KINKS & WRINKLES** (for Experimenters) by C. Washburne

No. 8 **RADIO QUESTIONS & ANSWERS**, by R. D. Washburne

No. 9 **AUTOMOBILE RADIO & SERVICING**, by Louis Martin

No. 10 **HOME RECORDING AND ALL ABOUT IT**, by Geo. J. Saliba

No. 11 **FUNDAMENTAL PRINCIPLES OF RADIO**, by Louis Martin

No. 12 **HOW TO BUILD AND OPERATE SHORT-WAVE RECEIVERS**, by the Editors of SHORT WAVE CRAFT

No. 13 **HOW TO BECOME AN AMATEUR RADIO OPERATOR**, by M. F. Eddy

PRICE PREPAID **\$ .45**  
EACH BOOK  
PRICE PREPAID FOR ALL 13 BOOKS **\$4.85**

# A New National Super-het —The FB-7

(Continued from page 727)

advantage of the benefits which the ground connection sometimes brings as a result of grounding the chassis, without the necessity of having the ground connected to the antenna system, which is permitted to function as an almost separate entity from the remainder of the receiver.

In selecting the proper tubes for the first detector, a considerable amount of time was spent in investigating the performance of the type 58 tubes. This was abandoned in favor of the 57 because it was found that, with a 24 employed as the high frequency oscillator, having its plate coupled through the comparatively small condenser (approximately 2 mmf.) to the grid of the 57 detector tube, provided an arrangement which gave a coupling which automatically increased as the coils covering higher frequency ranges were plugged in.

Stable operation of the high-frequency oscillator, resulting in an unwavering signal response, has been obtained by using the 24 tube in what is called an *electron-coupled* circuit. The other 24 tube, employed for providing the beat frequency, when the reception of continuous waves is desired, is also of the electron-coupled type. The intermediate frequency amplifier employs two type 58 tubes and standard National commercial type intermediate frequency transformers, which are of the Litzendraht, ultra high gain variety. In other respects, the intermediate amplifier is fairly conventional.

For the second detector a 56 tube was selected because it can supply a high audio output, for the ease with which the radio frequency component may be removed from the plate circuit without sacrificing high audio frequency, and its adaptability for use with headphones.

The beat frequency oscillator is of the *electron-coupled* type. The usual difficulty of a broad zero-beat region, excessive noise in the intermediate frequency circuit as well as an apparent "pulling in" of strong signals as the volume control is advanced, has been overcome by suitable shielding of the oscillator circuit. As a result of the improved shielding, there is practically no *pick-up* in the input circuits of the intermediate amplifier and first detector.

The output tube is a type 59 pentode, which is coupled to the second detector by the resistance method.

### Answers to Most Questions

It is impossible to give a complete description of a receiver of this nature within the space available in a magazine article, but a preview of this receiver has resulted in the answering of a great number of questions and the answers to these questions follow. A few points which have not been brought out by the questions have to do with the selections of the materials necessary for a particular type of service or for general purpose. As a matter of convenience to those who do not require all of the coils the receiver may be purchased with a single set of coils and additional coils may be secured as the need for them arises. Then, too, the regular power supply is optional. The receiver functions very satisfactorily with a storage battery for supplying the filament current and "B" batteries. As is general in the operation of amateur receivers, it is possible to utilize the filament transformer operated directly from the light circuit and have the plate supply come from "B" batteries.

### Questions and Answers on the FB-7

For what particular purpose has this new receiver been designed?

The FB-7 has been designed primarily to enable the 80 meter amateur phone operator to secure what corresponds to commercial performance from a receiver designed especially for amateur use at a price heretofore impossible.

What is the output impedance and what type of loud speaker is recommended?

The output impedance is suitable for best operation with any standard 5,000 ohm magnetic or dynamic speaker.

What is the overall frequency range?

Standard coils are available for complete coverage from 20 mc. to 1,500 kc. (15-200 meters). Five pairs of general coverage coils cover the following ranges: 11,500-20,000 kc.; 6,900-12,000 kc.; 4,050-6,900 kc.; 2,400-4,400 kc.; and 1,300-2,600 kc.

Are band spread coils available and for what bands?

Yes. For all of the amateur bands. Each set of these coils provides a spreading of the band over a full 100 divisions of the dials. These 100 divisions come right in the center of the dial scale and there are thus 25 divisions above and 25 below the actual band covered by each pair of coils.

Is this receiver suitable for C.W. reception as well as for phone?

Yes. A switch on the front of the panel controls the special beat frequency oscillator used for C.W. reception.

Is the receiver subject to frequency drift?

No. Both the oscillators are of the electron-coupled type. This completely eliminates any tuning drift common and troublesome in other short wave superheterodynes.

Are the coils shielded?

They are not only shielded but they have been designed to fit right into the apertures in the front panel in the same convenient manner as with the AGS. They are provided with aluminum face plates and convenient grips. It is not necessary to remove the coil shields, or raise the lid of the receiver in order to change the coils.

Can intermediate stages be tuned to assure peak efficiency at all times?

Yes. The trimmer adjustments are located at the top of the intermediate frequency transformers, making it unnecessary to remove the base of the receiver or go to any other complicated trouble to assure peak performance at all times. Peaking the I.F. amplifier is a very simple matter.

Is straight frequency line tuning employed?

Yes. The latest National, illuminated, full-vision dial is used in conjunction with 270 degree straight frequency line condensers. This combination spreads the band, covered by a given set of coils over 50 per cent more dial space, than would be possible with 180° condensers.

Is the receiver thoroughly shielded?

In addition to complete shielding of each of the components, in themselves, the entire receiver is contained in an all-metal cabinet. This double shielding contributes to the inherent stability of the receiver and prevent the picking up of stray interference.

Can the receiver be used with headphones?

Yes. The jack is on the front of the panel and permits ready connection of the headphones into the output of the second detector.

(Coil and other data will appear in next issue)

there's  
everything you want  
in this big illustrated  
science monthly . . .  
plenty of home work-  
shop articles too . . .  
and it's

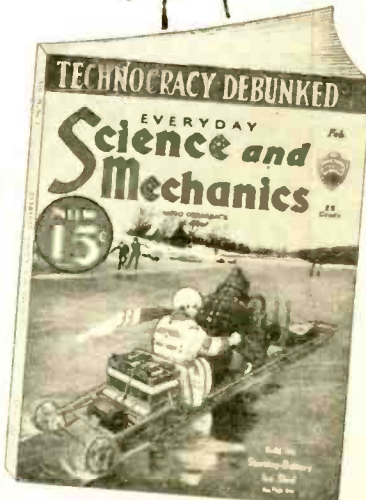

Over 375 Illustrations—30 pages—4-Color Cover  
9 x 12 inches

WE DO not hesitate to say that EVERYDAY SCIENCE AND MECHANICS is the finest scientific-technical-mechanical-constructional magazine in the field. Right up-to-the-minute with news flashes of scientific events from all parts of the world. Dozens of constructional articles for making useful things for the shop, garden and home. Many ideas from which you can make things to sell.

Get this magazine at your newsstand today. Read about the many cash prizes which are offered for simple experiments in photography, oddities in science, uses of old auto parts, radio experiments, recipes, formulas and others.

- |   |                      |
|---|----------------------|
| <b>A Host of Interesting Scientific Subjects—</b> | <b>NEW DEVICES</b>   |
| <b>RADIO</b>                                      | <b>CONSTRUCTION</b>  |
| <b>TELEVISION</b>                                 | <b>METAL WORKING</b> |
| <b>ELECTRICITY</b>                                | <b>PHYSICS</b>       |
| <b>PHOTOGRAPHY</b>                                | <b>ENGINEERING</b>   |
| <b>AVIATION</b>                                   | <b>METALLURGY</b>    |
| <b>WOODWORKING</b>                                | <b>HOUSEHOLD AND</b> |
| <b>AUTOMOBILES</b>                                | <b>SHOP HINTS</b>    |
| <b>PATENTS AND</b>                                | <b>AND OTHERS</b>    |
| <b>INVENTIONS</b>                                 |                      |

**\$1.50 FOR A YEAR**

**Mail Coupon NOW!**

EVERYDAY SCIENCE AND MECHANICS SW-433  
100 Park Place, New York, N. Y.  
I enclose herewith \$1.50 for which you are to enter my subscription to EVERYDAY SCIENCE AND MECHANICS for One Year.

Name \_\_\_\_\_  
Address \_\_\_\_\_  
City \_\_\_\_\_ State \_\_\_\_\_

# 89¢ SALE!

of VALUABLE REFERENCES for HOME, OFFICE and SCHOOL

Postage 11c per book. Postage FREE if 5 books are ordered. (Formerly \$1.50 to \$7.85)

**A Genuine Friend in Need!**

**89c** (Formerly \$6 in 4 vols.)



Right at your finger-tips are instant answers to every question. Get the book! . . . Look up in the Index! A bad cold? Feel bad all over? Stomach upset? Feel tired, run down? Here you find out what's the matter, what to do in ordinary illness; how to treat until Doctor gets there in serious cases. In half a million American homes this New Home Medical Adviser is a daily guide, counsellor and friend. It is kept handy beside atlas, dictionary, almanac, Bible and other references so everyone can quickly refer, read, learn, understand and KNOW. Sixteen medical specialists here in 1 handy book. The leading home medical authority for 25 years. Authentic, proven, newly revised and up-to-date on latest medical practices.

**How to Diagnose and Treat:**

Anemia, Heart Trouble, Diarrhea, Billiousness, Indigestion, Worms, Nervous Debility, Gout, Delirium Tremens, Nervous Collapse, Insanity, Apoplexy, Colds, Toothache, Diphtheria, Heat Stroke, Food Poisoning, Earache, Rheumatism, Lumbago, Stiff Neck, Hives, Itching, Rupture, Piles, Tumors, Typhoid Fever, Malaria, Smallpox, Vaccination, Erysipelas, "Pink Eye," Deafness, Earache, Measles, Sex Hygiene, Gonorrhea, Syphilis, Sexual Functions, Abuse, Duties of Parents, Marriage Relations, Bright's Disease, Puberty, Menstruation, Leucorrhoea, Childbirth, Children's Diseases, Croup, Bowlegs, St. Vitus' Dance, Personal Hygiene, Skin, Hair, Teeth, Diet, Home Exercises, Rest, Weight and Height, Emergency Treatment for Burns, Fractures, Rites; Lightning Stroke, Sunstroke, Poisons and All Accidents.

**1. NEW HOME MEDICAL ADVISER.** 472 pages. Fully illustrated, many in color. Full-page body charts. Well bound gold stamped, size 5x7 1/2. Complete in 1 handy vol. (Formerly in 4 vols., \$6.) **89c** Our Bargain Price (postage 11c extra)

**2. FAMOUS WOMEN.** When Cleopatra was 18 she bore Caesar a son! Curious and hitherto unknown facts at last revealed in these 499 short biographies of famous (and infamous) women. Semiramis to

Mary Pickford. 328 pages. 32 full-page portrait illustrations. (Formerly \$3.) Our Bargain **89c** Price (postage 11c extra)

**3. GRAPHOLOGY**, or, Character Analysis from Handwriting. Easy to discover truth about friend or enemy if you have his signature. Easy to read, understand and apply. Valuable in business, love affairs, society. This book is the recognized authority. 200 pages, cloth bound. (Formerly \$3.) Our Bargain Price **89c** (postage 11c extra)

**4. THE SECRET OF GOLD**, by Robert Callier, world-renowned writer and teacher of practical psychology. How to realize Money by easy psychology methods. Anyone can read, use, learn and benefit. (Formerly 7 vols., \$7.85.) Same text now in 1 vol. Bright red arterial, handsomely embossed. Our Bargain Price (postage 11c extra) **89c**

**5. THE BOOK OF FATE.** Napoleon's own fortune teller—found on his body at his death. Reproduced from ancient Egyptian mss. Answers all questions about love, business, travel, money, the future. Well bound, 200 pages. (Formerly \$2.50.) Our Bargain Price (postage 11c extra) **89c**

**6. BIBLE JINGLE RHYMES** The great events of the Bible made real and personal to children. An enjoyable book for all. Pleasant way of teaching the Bible. 209 pages. Large Size. Illustrated. (Formerly \$2.00.) Our Bargain Price **89c** (postage 11c extra)

**7. FORTUNE TELLING.** With Cards How to Read Them. Two books. The leading authorities on these subjects. Valuable, instructive, great fun. Beautifully bound. Each book formerly sold for \$1. Our Bargain Price (postage 11c extra) **89c**

**8. COCKTAILS AND PUNCHES**, by Charles DeLimonico's. 150 recipes. How to mix popular, rare, exquisite and delicate drinks. A drink for every purpose and mood. Favorite drinks of celebrities. (Formerly \$1.50.) Our Bargain Price (postage 11c extra) **89c**

**9. MOTHER'S MANUAL.** Liberally illustrated in box with full set of McCall Layette patterns. What to do before baby comes and after it arrives. Hygiene, weight charts, baby biography. (Formerly \$3.50.) Our Bargain Price (postage 11c extra) **89c**

**10. PERSONAL MAGNETISM.** How to develop a personality that attracts money, love and the things you want. How to be popular. How to make people WANT you. So easy that anyone can understand and apply at once. (Form. \$2.) **89c** Our Bargain Price (postage 11c extra) **FREE BOOK WITH EVERY ORDER**

While our 238 copies last, we will include in your shipment without extra charge 1 copy of "The Winning Principle of Success" (value \$1.) Rush order to make sure of getting this free book. POSTAGE FREE if you order 5 books (\$4.45 worth.) Stock up NOW for season's entertainment and study. Mail this coupon TODAY!

SCIENCE PUBLICATIONS, 945 PARK PLACE, NEW YORK, N. Y.

Please send me the books I have circled below for which I enclose \$..... to cover purchase price and postage. I understand that my money is to be refunded on any unsatisfactory purchase.

1      2      3      4      5      6      7      8      9      10

Name.....

Address..... City..... State.....

(POSTAGE FREE if 5 or more books are ordered. Otherwise include 11c per book postage with remittance.)

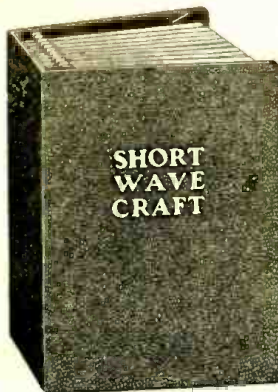

**Short Wave Craft** is not the sort of magazine that you read and then discard.

Readers keep their copies for years as a steady reference and thousands of letters attest to this fact.

It is now possible to save your copies and for this purpose we designed a splendid binder for you which holds twelve copies. It is made of heavy substantial material and is covered with black grain leatherette. The name of the magazine is stamped in gold on the cover.

An ingenious mechanical arrangement is provided which makes it possible to hold the copies flat when reading from the binder.

SHORT WAVE CRAFT Binder as described, prepaid in the United States..... **\$125**

Canada and foreign countries 25c extra. We accept money order, check, stamps or cash.

SHORT WAVE CRAFT 98 Park Place New York, N. Y.

## The Oscillodyne

(Continued from page 747)

no difficulty should be experienced from improper wiring. In preparing a lead to which several connections have to be made, such as the ground connections, a much more convenient method of removing wax impregnated insulation than by scraping off with a knife, is to mash the insulation at the desired points with a pair of long-nosed pliers. The insulation can then be readily removed with the fingers. Soldered connections are not essential but should be made if possible.

The 50,000 ohm variable resistance should have an insulated shaft and bushing so that it can be directly mounted to the aluminum panel. Otherwise, it will be necessary to first mount the instrument to a strip of bakelite, which in turn is mounted to the panel. If this is done, the shaft hole should be large enough for proper clearance. A potentiometer can obviously be used for this purpose by employing only one of the two outside terminals.

In making connections to the variable condenser, the ungrounded terminal should be connected to the grid condenser so that the panel will be at ground potential.

### Operating Notes

When ready to operate the receiver, the first thing to do, of course, is to make the various connections to the antenna, ground, "A" and "B" supply, and phones. The antenna compensating condenser, C1, should be set at close to its minimum value. The variable condenser should be set so that its plates are within about 15° of "all-in"; and coil No. 3 inserted in the coil socket. The variable resistance R2 should be set so that its maximum resistance is in the circuit.

The circuit is now tuned somewhere near the 80 meter amateur phone band. If the set is now turned on, a fairly loud high-pitched note should be heard in the earphones. The resistance R2 should now be decreased until this note becomes inaudible and a "hissing sound" is heard. If the variable condenser is now rotated slightly it should be possible to tune in an amateur phone transmitter. When this is done the resistance R2 should be varied for best reception. The antenna compensating condenser should now be set for maximum volume.

When using the 20 meter and 40 meter coils it will generally be found necessary to increase the resistance R2 to a greater value than required for the 80 meter coil. While this control is not nearly as critical as the regeneration control in a regenerative receiver, it is, nevertheless, necessary to exercise some skill in its manipulation before maximum results can be obtained.

It will generally be found that when foreign stations are to be received they will come in with nearly the same ease as locals; while when they are not to be received all the coaxing in the world will not bring them in. The absence of foreign stations on the dials can be attributed to a number of causes. In the first place, there may not be any broadcasting at the time the listening is being done; or the frequency band on which listening is being done may not be suitable for foreign reception at that particular time of day.

In general, it will be found that from daybreak to about 2 p. m. foreign reception is best on 14 to about 20 meters; from 2 p. m. to 9 p. m. on 20-35 meters, and from 9 p. m. to daybreak on 35-75 meters.

Even when listening at the right time to a foreign station that had been received regularly for days, it will often be found that the station has suddenly disappeared entirely only to reappear, just as suddenly, a week or so later. Experiences of this nature are very common on short waves and can only be attributed to the vagaries of short wave transmission.

### Trouble Shooting

Difficulties encountered in getting the set functioning properly can be grouped

(Continued from page 762)

in three classifications as follows:

1. Set refuses to operate.
2. Set oscillates but will not break into irregular oscillation.
3. Set oscillates irregularly but does not function properly.

To determine whether the set is oscillating or not touch the terminal of the grid condenser that is *not* connected to the grid. If this results in a click in the phones the set is oscillating, and vice versa. If the set is not oscillating the first thing to determine is whether plate current is flowing. This can be determined by disconnecting one of the phone leads and making and breaking this connection by hand. If this results in corresponding loud clicks in the phones, plate current is flowing and the difficulty is elsewhere. If plate current is not flowing there is probably an "open circuit" in the plate or heater circuit. Make sure that the plate potential is not reversed; also that the coil is making contact with the socket and that the B- (minus) terminal is connected to the cathode. Also re-examine the plug-in coil to make certain that the connections have been made properly. Also make certain that the tube is not defective.

If the tube oscillates but does not break into irregular oscillation (high pitched note in earphones with R<sub>2</sub> at maximum) make certain that the plate and filament voltages are correct. Also make sure that the tube is not faulty. Reduce the antenna compensating condenser to its minimum value or temporarily disconnect the antenna. If this procedure rectifies the trouble, the antenna condenser has too large a minimum capacity and a smaller one should be substituted. Rock the plug-in coil slightly to make sure there is not a high-resistance contact.

If the tube oscillates irregularly, but the set does not function properly, the trouble is probably with the tube or grid condenser and leak combination. If a new tube does not improve results, try a .00005 mf. grid condenser at C<sub>2</sub> and experiment with different values of leak resistance from about one to seven megohms.

The editors of SHORT WAVE CRAFT had a special highly insulated model of the Oscillodyne built and this is the model shown in the front cover illustration and in the photographs herewith. Of course, results can be obtained with a bread-board model, thrown together with odd parts, but, as in every piece of electrical apparatus—and particularly in the case of a sensitive radio receiving set such as the Oscillodyne, which is designed to realize the greatest possible strength of signal from one tube, it behooves us to thoroughly insulate every part of the set to the best of our ability.

To that end, the coils were wound on Hammarlund Isolanite forms. As is well known, Isolanite is superior to ordinary Bakelite for use as an insulator in short wave and ultra short wave work. Next, Isolanite sockets were used for both the tube and the coil and all of the parts were mounted on a bakelite subpanel, to still further enhance the insulation.

**Parts List For Building the Oscillodyne**

- 1—Aluminum panel, 4½"x6"x¼". Blan (Insuline Corp. of America.)
- 1—Bakelite subpanel, 4½"x5½"x3/32". Insuline Corp. of America.
- 1—50,000 ohm variable resistor, R2, Frost, (Clarostat).
- 1—Set of 4 pin plug-in coils wound on Hammarlund Isolanite forms 1½" dia., per specifications given in article.
- 1—Series antenna condenser, C1, about 25 mmf. max., Hammarlund Compensator type condenser.
- 1—Variable tuning condenser, C2, .0001 mf., Hammarlund.
- 1—Grid condenser, C3, 100 mmf., or 50 mmf. Illini (Polymet)
- 1—Fixed resistor, R1, 3 megohms, Lynch,
- 1—Fixed condenser, C4, .0005 mf., mica type, Pilot or Flechtheim. (Polymet)
- 7—Binding posts, Eby.
- 1—3" midget National Velvet Vernier Dial, type BM.

# an old timer says—

San Francisco, Calif.

Gentlemen:

Allow me to congratulate you on Myron F. Eddy's "How to Become an Amateur Radio Operator." I have been a "ham" since 1909 and have worked up from the open crashing sparks of "Old Betsy's" and took sullenly to these new fangled gadgets and had to park "Betsy" in the junk heap under the eaves to go in for tubes. I'm too old now to dabble in the game very much but in my teaching a bunch of ether disturbing young squirts here—all Boy Scouts, I still get a certain "kick" out of it. I purchased nine copies for my gang and I suppose five or six others got them because they saw ours—had to send to Oakland for three additional copies. They're GREAT!

One of the "Old Men" of Radio

Ex. Lieut. Al. A. Weber (Retired)  
1153 Capp St., San Francisco, Calif.



50c EACH

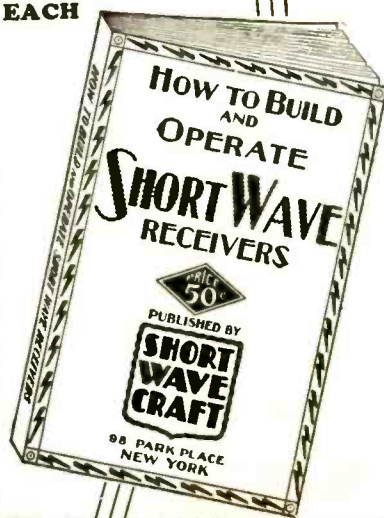

**SHORT WAVE CRAFT**  
96-98 SWC Park Place,  
New York, N. Y.

Gentlemen: I enclose herewith \$.....  
for which please send me, prepaid a copy  
of the book checked.

( ) HOW TO BUILD AND OPERATE  
SHORT WAVE RECEIVERS—50c  
( ) HOW TO BECOME AN AMATEUR  
RADIO OPERATOR—50c.

Send money order, check, cash or new  
U. S. stamps. Register letter if it  
contains stamps or currency.

Name .....

Address .....

City..... State.....

THERE is not a radio man in the field, experimenter, service man or dealer who will not want to read these two books. Right up to the minute with outstanding developments in short-wave radio—new methods and apparatus for quickly learning how to become a practical radio operator. Each book is authoritative, completely illustrated and not too highly technical. The text is easily and quickly grasped.

**How to Become an Amateur Radio Operator**

We chose Lieut. Myron F. Eddy to write this book because his long years of experience in the amateur field have made him pre-eminent in this line. For many years he was instructor of radio telegraphy at the R.C.A. Institute. He is a member of the I.R.E. (Institute of Radio Engineers), also the Veteran Wireless Operators' Association.

If you intend to become a licensed code operator, if you wish to take up phone work eventually, if you wish to prepare yourself for this important subject—this is the book you must get.

**Partial List of Contents**

Ways of learning the code. A system of sending and receiving with necessary drill words is supplied so that you may work with approved methods. Concise, authoritative definitions of radio terms, units and laws, brief descriptions of commonly used pieces of radio equipment. This chapter gives the working terminology of the radio operator. Graphic symbols are used to indicate the various parts of radio circuits. General radio theory particularly as it applies to the beginner. The electron theory is briefly given, then waves—their creation, propagation and reception. Fundamental laws of electric circuits, particularly those used in radio are explained next and typical basic circuits are analyzed. Descriptions of modern receivers that are being used with success by amateurs. You are told how to build and operate these sets. Amateur transmitters. Diagrams with specifications are furnished so construction is made easy. Power equipment that may be used with transmitters and receivers, rectifiers, filters, batteries, etc. Regulations that apply to amateur operators. Appendix which contains the International "Q" signals, conversion tables for reference purposes, etc.

**How to Build and Operate Short Wave Receivers**

is the best and most up-to-date book on the subject. It is edited and prepared by the editors of SHORT WAVE CRAFT, and contains a wealth of material on the building and operation, not only of typical short-wave receivers, but short-wave converters as well. Dozens of short-wave sets are found in this book, which contains hundreds of illustrations; actual photographs of sets built, hook-ups and diagrams galore. The book comes with a heavy colored cover, and is printed throughout on first-class paper. No expense has been spared to make this the outstanding volume of its kind. The book measures 7½x10 inches.

This book is sold only at such a ridiculously low price because it is our aim to put this valuable work into the hands of every short-wave enthusiast.

We know that if you are at all interested in short waves you will not wish to do without this book. It is a most important and timely new radio publication.

**Over 150 Illustrations in Each Book**

**72 Pages Heavy 7x10 Inches Heavy Colored Covers**

**Not Sold on Newsstands**

**SHORT WAVE CRAFT**

96-98 Park Place, New York, N. Y.

**New! New!! New!!!**

**TWO NEW 25c SHORT WAVE BOOKS**

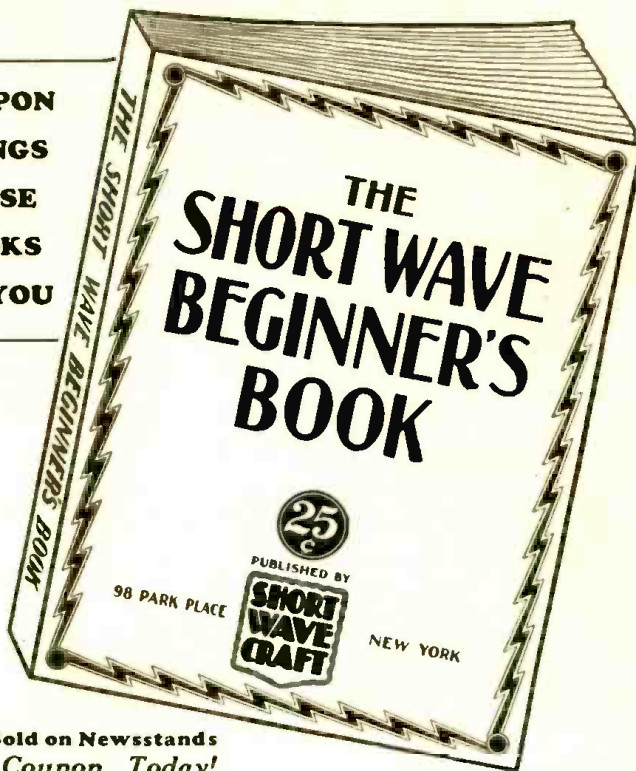
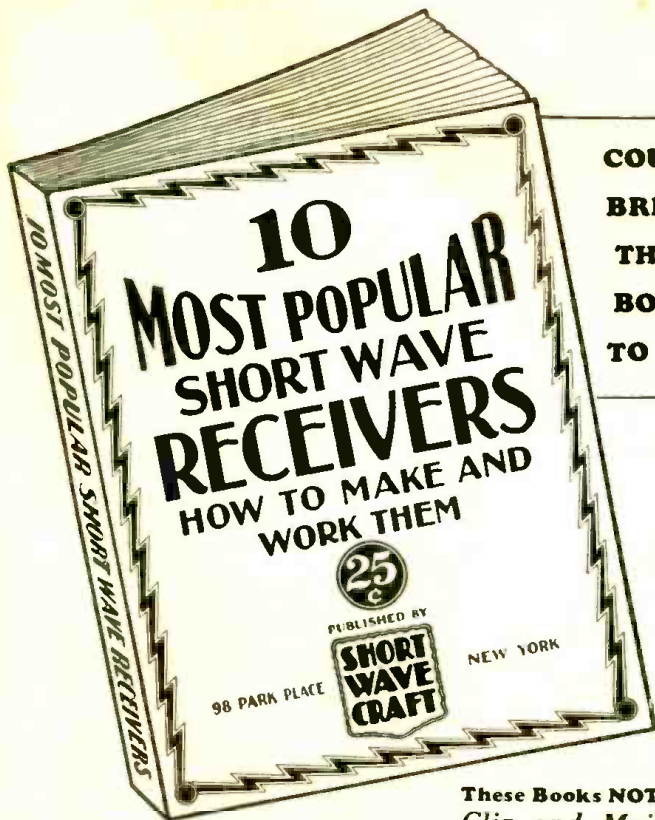

**COUPON  
BRINGS  
THESE  
BOOKS  
TO YOU**

**These Books NOT Sold on Newsstands  
Clip and Mail Coupon Today!**

**HERE IS GREAT NEWS**

PURSUANT to many requests from our readers, we have decided to publish two new popular short wave books, for which there is a persistent demand at this time. These new books contain everything on the subjects worth knowing and both books will be welcomed by all short wave experimenters, short wave fans and short wave enthusiasts, the same as our former two books HOW TO BUILD AND OPERATE SHORT WAVE RECEIVERS, and HOW TO BECOME AN AMATEUR RADIO OPERATOR were welcomed by thousands of our short wave friends.

instead of 50c, which is the price of our other books. Yet the two new 25c volumes that we are offering now contain a tremendous amount of information and the type and illustrations have been chosen in such a manner as to give you almost as much for your 25c as you received for your 50c before. Only by increasing the press run enormously and making other printing economies has it been possible to price these books at such a low, popular price. You will make no mistake in getting either or both of these new and popular books and we know in advance from our many years of experience with short wave enthusiasts that you will thank us for having made these books possible.

**Ten Most Popular Short Wave Receivers.  
How to Make and Work Them**

This new volume will be a revelation to all those who wish to build their own short wave receivers. The editors of SHORT WAVE CRAFT over a period of years have learned to know exactly what short wave experimenters and short wave set builders want to get. For that reason they have selected ten outstanding short wave receivers and these are described in the new volume. Everything worthwhile about every one of the ten receivers is described in the text. Each receiver is fully illustrated and each receiver has a complete layout, pictorial representation, photographs of the set complete, hookup and all worthwhile specifications, so there is nothing left to your imagination when it comes to building any one of these ten popular receivers. Everything from the simplest one tube set to a six tube superheterodyne is presented. Complete lists of parts are given to make each set as complete as it is humanly possible to do. You can select any or all receivers and know beforehand that you will be able to successfully build and operate such a receiver and not waste your money in building some theorist's dream-child. You will also be shown how to operate the receiver to its maximum efficiency.

**IMPORTANT**

THERE IS NO DUPLICATION WHATSOEVER BETWEEN THIS BOOK AND OUR OTHER VOLUME—"HOW TO BUILD AND OPERATE SHORT WAVE RECEIVERS." ALL THE MATERIAL PUBLISHED IN THE NEW BOOK HAS NEVER APPEARED IN ANY BOOK BEFORE.

This book has been edited by the editors of SHORT WAVE CRAFT, which alone is a guarantee that you will get satisfaction and that nothing has been left undone to give you between two covers the greatest selection of short wave receivers ever published.

**PRICE 25c PREPAID 40 PAGES  
OVER 75 ILLUSTRATIONS**

**A Short Wave Beginners Book**

Here is a book that will solve your problems if you are new to the short wave game. It contains positively everything that you would wish to know in connection with short waves, leading you in easy stages from the simplest fundamentals to the present stage of the art in short waves as it is known today. It is the only low-priced reference book on short waves for the beginner, whether he be a short wave enthusiast, short wave listener or short wave amateur.

The book is profusely illustrated with all sorts of illustrations, explanations and everything worthwhile knowing about short waves in this interesting and growing field. Yet without the book is not "technical." It has no mathematics, no "high-faluting" language and no technical jargon which would only serve to frighten you away. The entire book is kept in popular language throughout. Wherever technical words are used, explanations are given, leaving nothing to the imagination. You are shown how to interpret a diagram and a few simple sets are also given to show you how to go about it in making them. Yet everything has been done to make it possible to give you a complete understanding of short waves from the ground up.

After reading this book, you will never be at a loss for short wave terms and you will not have to consult other text-books or dictionaries. The editors of SHORT WAVE CRAFT who have edited this book have seen to it that everything has been done to make this volume an important one that will be used as reference for years to come by all those who wish to break into the short wave art. The book covers everything, "from soup to nuts" and will be of tremendous importance to everyone.

It abounds with many illustrations, photographs, simple charts, hook-ups, etc. all in simple language. It also gives you a tremendous amount of very important information which you usually do not find in other books, such as time conversion tables, all about aerials, noise elimination, how to get verification cards from foreign stations, all about radio tubes, data on coil winding and dozens of other subjects.

The book is just chock full of information and you will never regret having noticed this important volume. You will keep referring to it every day in your work.

**PRICE 25c PREPAID 40 PAGES  
OVER 75 ILLUSTRATIONS**

SHORT WAVE CRAFT SW-4-33  
96-98 Park Place, New York City.  
Gentlemen:

I enclose herewith 25c, for which please send me as soon as published, prepaid, a copy of your new book "Ten Most Popular Short Wave Receivers. How to Make and Work Them." The book to be sent to me immediately upon publication.

I enclose herewith 25c for which please send me as soon as published, prepaid, a copy of your new book "The Short Wave Beginners Book." The book to be sent to me immediately upon publication.

I enclose 50c for which please send me, prepaid, as soon as published, your two books, "Ten Most Popular Short Wave Receivers. How to Make and Work Them," and "The Short Wave Beginner's Book." The books to be sent to me immediately upon publication.

(Send money order, check, cash or new U. S. stamps. Register letter if it contains currency or stamps).

Name .....

Address .....

City ..... State .....

# Radio on the Ultra Short Waves

(Continued from page 745)

big advantage of plate and inner filament tuning was not being realized.

Fig. 5 gives the schematic diagram of our latest receiving circuit, which is in present use.

Numerous distance tests, and a few official demonstrations, have been given from time to time, and each has gone to prove the availability and practicability of these very short waves for the purposes of radio communication.

The first demonstration was given to representatives of the Italian Ministry of Communications early in October, 1931, between Santa Margherita and Sestri Levante, near Genoa, a distance of 11 miles over sea.

The transmitter, consisting of two radiating units working into four reflector units, was installed at Santa Margherita on the balcony of a private villa at a height of 50 metres (164 ft.) above sea-level.

The receiver, which was of our first type, without plate or inner filament tuning and without super-sonic variable plate bias, was installed on the top of a small signal-station tower at Sestri Levante at a height of 70 metres (230 ft.) above sea-level.

The elevation of the two instruments was capable of giving a direct line of vision over a distance of 24 miles, that is to say, slightly more than twice the actual distance at which the test was carried out.

On October 29, 1931, a second demonstration was given to the same experts and between the same places with an improved receiver, fitted with variable super-sonic plate bias.

The third demonstration took place on November 19, 1931, between the same experimental transmitting station at Santa Margherita and Levante, a distance this time of 22 miles, mostly over sea.

The receiver at Levante was installed on the balcony of a private villa, at a height above sea-level of 110 metres. The sum of the heights of the two stations was 160 metres, which is sufficient for direct vision over 27.5 statute miles, or 20 per cent in excess of the distance covered.

The next was a duplex demonstration, which took place on April 6, 1932, again between Santa Margherita and Sestri Levante. Its purpose was to show the advanced model incorporating two-wire telephone terminal apparatus, and to demonstrate the practicability and the resulting advantages of working both transmitter and receiver in the same reflector. Excellent two-way communication was maintained on two wires for several hours.

Soon after the duplex demonstration of Santa Margherita-Sestri Levante, the Vatican authorities decided to adopt the new system for telephonic communication between the Vatican City and the Palace of His Holiness the Pope at Castel Gandolfo, near Rome.

## Entirely Over Land

This application is of great interest as the distance between the two points, a matter of 20 kilometres (12 miles), is entirely over land, and also because there is no actual clear vision between the two places, on account of the intervening trees in the Vatican Garden and those of the avenue built over the Gianiculum Hill, situated at about 4 miles from the Vatican.

Having at the time no experience of such working conditions, it was decided to check beforehand the possibility of successfully operating such a circuit.

For that purpose, a small experimental single-transmitter single-reflector unit was placed at the Vatican City and a standard receiver with a single-unit reflector was installed first at the College of Mondragone, east of Castel Gandolfo, from which a direct vision of the transmitter was possible, and afterwards at Castel Gandolfo.

These interesting tests took place towards the end of April, 1932, and were entirely successful, the signals being re-

ceived with great strength at Mondragone and afterwards only slightly weaker at Castel Gandolfo, leaving no doubt as to the possibility of successfully linking together the two places, notwithstanding what would generally have been considered unfavorable conditions.

It is also interesting to mention that to reach Mondragone the waves had to pass through the masts and aerials of the high-power radio station of the Italo Radio Company at Terranuova.

## First Commercial Link

At the end of November, the apparatus for the first commercial link on a wavelength below 1 metre (1 metre-39 inches) was installed and tested.

Fig. 4 shows the transmitter and receiver which are working in the same reflector, recently installed on the roof of the annex of the main Vatican wireless station.

Fig. 6 shows the remote control of this transmitter and receiver as well as the telephone terminal equipment which permits the extension of the radio circuit to any ordinary Vatican or outside telephone line. Fig. 7 gives the back view of the same apparatus.

With the object of carrying out long-distance tests, a five-unit reflector four-unit transmitter was constructed, which constitutes what I believe to be the most powerful short-wave transmitter yet produced.

This transmitter induced 30 milliamperes in the standard wavemeter at a distance of 12 metres, representing 21 wavelengths from the aperture of the reflector.

Fig. 8 is a photograph of this experimental transmitter, while Fig. 9 illustrates the four-unit transmitters, working in phase side by side, mounted inside the screened box behind the reflectors.

In July, 1932, one of our standard receivers with a single-reflector unit was installed astern of the main deck of the yacht *Electra*, and preliminary tests were carried out with the new powerful transmitting station installed at Santa Margherita.

These tests demonstrated that although the optical distance corresponding to the small height of the Santa Margherita station and the *Electra* was only 14.6 nautical miles, the signals were still perceivable at a distance of 23 miles, well beyond the optical range and notwithstanding the intervening curvature of the earth.

These signals began to lose strength noticeably at about 11 miles from Santa Margherita, that is, before reaching the optical limit, but after passing that position they were observed to decrease in strength only gradually, until no longer perceptible.

## Deep Fading

Above a distance of 22 miles the signals were suffering from a kind of deep fading causing them to disappear completely from time to time.

At a distance of 18 miles the speech was still 90 per cent, intelligible, but from 20 miles until the signals could no longer be heard, tone morse signals only could be clearly identified.

At the end of July the equipment of the Santa Margherita station was transported to the obsolete Seismographic Observatory of Rocca di Papa, which is situated about 12 miles south of Rome at a height of 750 metres above sea level and about 15 miles inland.

On August 2, good duplex communication was established between that new experimental station and the yacht anchored in front of Ostia, a distance of about 18 miles, 57-centimetre waves being used from Rocca di Papa to the *Electra*, and 26-metre waves in the reverse direction.

On August 3, the yacht was forced to leave for Civitavecchia Harbour on account of bad weather, but the journey was utilized for a propagation test.

During this test, and with the view of keeping the beam directed on the yacht, the reflector at Rocca di Papa was turned 5 degrees east of Ostia every half-hour.

Very good signals were received on the (Continued on page 767)

# QUALITY APPARATUS FOR Short Waves

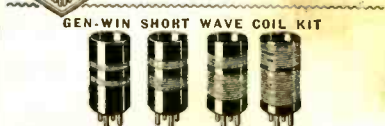

These coils are considered the finest made. Each coil is precision wound on a different colored bakelite form for quick identification of wave lengths. Used and highly recommended by all short wave experts. Range (16 to 22.5) meters, using a .00014 or .00015 mfd. condenser. Recommended for the following sets: "The Globe Trotter," "The Overseas," "The Durré 12,500 Mile Two Tube Receiver," and "Dorrie Three Tube Signal Gripping." "The Mercury," 4 Coil Enamel Wire } 4 Coil Litz Wire } \$2.25  
Kit \$1.50 }  
Broadcast Coil, (200 to 550 meters) } 55c

**POLICE AND SHORT WAVE ADAPTER**  
Convert your Broadcast set into a shortwave set tuning from 80 to 200 meters.



Get exciting police alarm from stations thousands of miles away. Airplane communications while in flight. Amateur phone and international code communications.

Plus directly into the detector tube in your set, or if uncertain as to detector tube, advise make and model number of set when ordering. No. 200—for '27, '37 \$1.39 and '56 Det. tube. No. 201—for '24, '35, and '36 Det. \$1.39

**ALL-WAVE COIL KIT**  
Range 25 to 550 Meters

Complete a portable wind-up tuner and R.F. coil, both having in paid section a d. or l. g. which permits you to enjoy both SHORT WAVE and BROADCAST PRO.

**CHAS.** If you own an Amnoscador or any other three circuit tuner receiver, you can easily convert it set into an all wave receiver, by replacing the coils, with these new GEN-WIN ALL-WAVE coils. Coils may be had for use with either 00003 or 00015 Mfd condenser. Specify which when ordering. Wire diagram included free with coils. Separately 10c. All Wave Tuner (as illustrated) 90c  
All Wave R. F. Coil 75c

**GENERAL WINDING COMPANY**  
214 FULTON ST. NEW YORK, N. Y.

# AERO INTERNATIONAL

## ALL WAVE 11-TUBE SUPER-HETERODYNE DE LUXE

Completely Assembled With 2 Matched Full Dynamic Speakers \$29.75

At last! World wide reception at a sane price. 15 to 550 meters. Besides the regular broadcast band, it brings in foreign programs, amateurs, police calls, ships at sea and aeroplanes. One dial control. No plug in coils. Latest super-sonic tubes.

## AERO 4-TUBE MIDGET

\$10.95 less tubes \$2.95 kit of tubes

The lowest priced quality Midget Receiver on the market today. Very selective, brings in long distance like local stations.

AERO 5-TUBE MIDGET \$11.99  
AERO 6-TUBE MIDGET 18.50

## AERO WORLD WIDE

1-Tube SHORT WAVE SET for Head-Phone Operation \$5.95

Listen in DIRECT to London, Paris, Berlin, Buenos Aires and other broadcasting stations throughout the world via short waves. Your ordinary receiver cannot tune in these low wave stations. WORLD-WIDE RECEIVER sets 15 to 500 meters. Aero 2-Tube Short Wave Set \$8.75. The same as above set but it has 1 stake of Audio Frequency added to it.

Write for Complete Catalogue  
**CHARLES HOODWIN CO.**  
4240 Lincoln Ave., Dept. C17 Chicago

**Just the Books You Need See Page 763**

# A NEW IDEA IN MAGAZINES

BY HUGO GERNSBACK

I HAVE been publishing radio magazines since 1908, and during this period I have learned to know what radio readers want. Last summer I made a trip through central Europe, in order to acquaint myself with radio conditions as they are in Europe today. I was amazed at the tremendous amount of radio experimenting that is now going on, in practically all of the western European countries. I found conditions similar to those during the 1921-1923 boom in America. Radio stores were prospering and doing a land-office business. The reason, of course, is the intense interest of the European radio experimenters who are building sets on a scale undreamt of before.

The European radio publications are abounding with new circuits and new radio developments that have found their way slowly over to the United States. The reason is that, since there is such a tremendous amount of original radio engineering going on in this country, there has been no publication that catered to the foreign developments. All the American radio publications must, of necessity, report the American activities first and as a rule, have no room left for what is going on in Europe unless an epoch-making development appears.

I therefore conceived the idea of bringing to my American readers a totally different radio publication, the like of which has never been published before; and the result is RADIO REVIEW AND TELEVISION NEWS.

This is not entirely a new magazine; it is, really, two magazines in one. A section devoted to television has been retained, which will report in every issue, the major American and European television advances; but the big, front section is given over to an international radio digest. This magazine, therefore, will perform the function that, for instance, the LITERARY DIGEST is serving in literature. You may not be aware of the fact that there are some 160 radio publications printed outside of the United States; but from all of these publications RADIO REVIEW is extracting the best—the Radio Meat—which you want.

There are literally thousands of new circuits, due to the new tubes, and there is so much new material for the experimenter that I would have to fill several pages to tell you all about it.

RADIO REVIEW AND TELEVISION NEWS then is a new mirror, which will accurately show you a true perspective of what is going on in radio all over the world, and will give you material in such profuseness as you never have seen before. Hundreds of new radio hook-ups, special circuits, new time-saving kinks, new money-making ideas galore. You will find here the latest radio circuits and sets from France, Germany, England, Italy, Russia, Norway and even Japan.

Dozens of translators have been busy to make the first issue of the new combination magazine a memorable one, that you will not soon forget, and you will wonder why I hadn't done it before.

And now I will ask you for a favor. Go to the nearest newsstand and get a copy of RADIO REVIEW AND TELEVISION NEWS. Pay your quarter for it, go home and look it over. If at the end of a week, you find that for any reason you do not like the magazine, return it to me with a letter stating why you don't want it, and I will refund your quarter. I am that sure that you will not wish to be without this magazine in the future.

Remember, you don't have to pay for the magazine unless you think it is what you are looking for.

If your newsdealer is sold out or does not stock the magazine send 25c to us (see coupon); money refunded if you don't want the magazine.

I thank you in advance for your patience and for your confidence.

Cordially yours,

*Hugo Gernsback*

### A few of the outstanding articles in the RADIO REVIEW section:

- |  |  |
|--|--|
| A Boom for Experimenters, An Editorial by Hugo Gernsback | A Complete Crystal Receiver in a Tobacco Can           |
| A Home Made Electric Theremin                            | The "Volume Speaker" Modifying Loud Speaker Tone Color |
| Matching the Load  | Sound From Drawings                                    |
| Modern Tuning Coil Practice                              | Radio Kinks Frob Abroad                                |
| A Band Pass Filter That Can Be Added to Any Receiver     | World Wide Hook-Ups                                    |
| The Screen Grid Tube As Detector                         | Review of American Radio Magazines                     |
|  | Notes on Gang Tuning                                   |
|  | Digest of Radio Patents                                |

### Features in TELEVISION NEWS section:

- |  |  |
|--|--|
| Making a 1200 R.P.M. Synchronous Motor     | A New Principle Applied to Television Superheterodynes |
| Lengthening Crater Tube Life               | How Screen News Is Televised                           |
| Rome Television Station Is Europe's Latest | List of Television Stations                            |
| Nipkow Still Lives!                        |  |

**Be sure to read full details in coupon!**

**THIS MAGAZINE COSTS YOU NOTHING UNLESS YOU LIKE IT. YOU TO BE THE SOLE JUDGE!**

### IMPORTANT

Do not confuse the former TELEVISION NEWS with this magazine. RADIO REVIEW AND TELEVISION NEWS are two distinct magazines in one.

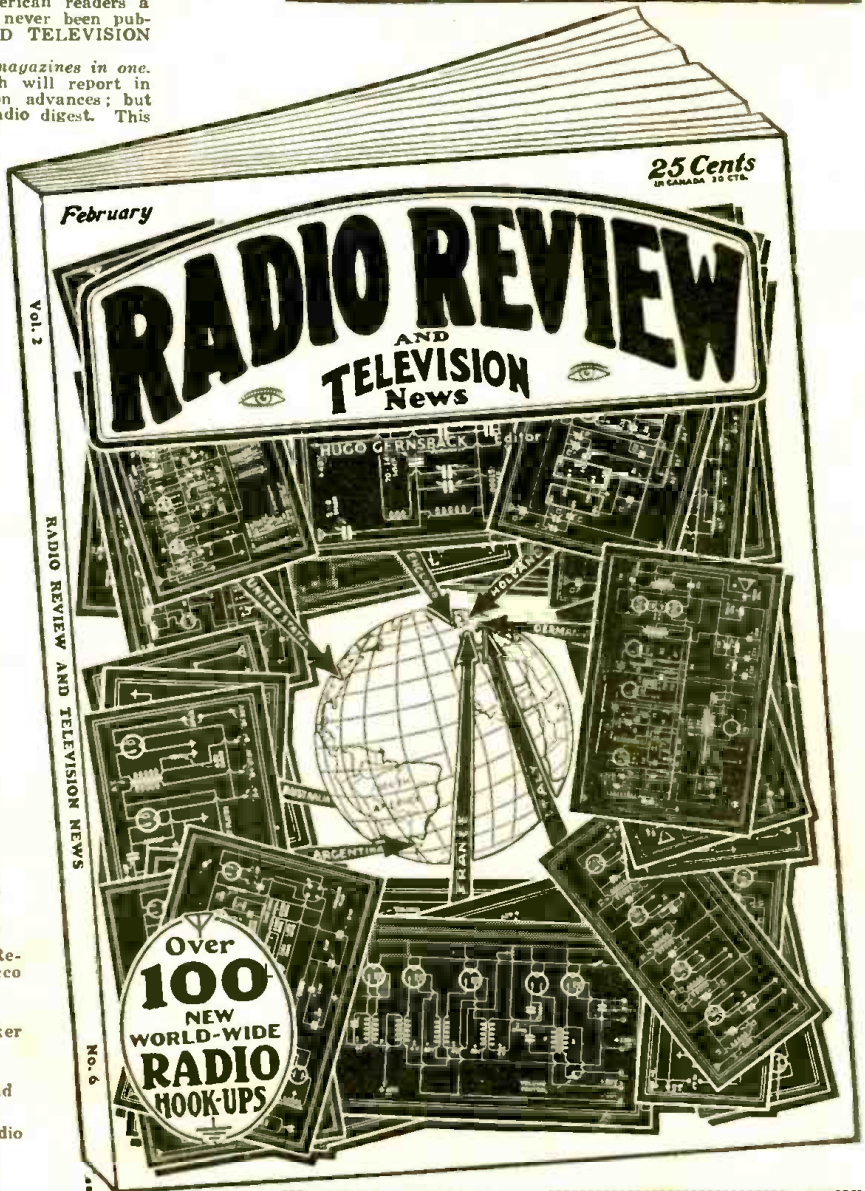

### RADIO REVIEW AND TELEVISION NEWS

98 Park Place New York City (Mark X in Square Which Offer You Desire) S.W.C. 4-33 Gentlemen:

As per your special offer, I enclose \$1.25 (Canada and Foreign \$1.50) for which enter my subscription to RADIO REVIEW AND TELEVISION NEWS for one year

Send me the current issue of RADIO REVIEW AND TELEVISION NEWS, for which I enclose 25c (U. S. stamps or coin accepted) with the full understanding that if I do not like the magazine you will refund the money as explained above

Name \_\_\_\_\_  
 Address \_\_\_\_\_  
 City and State \_\_\_\_\_



With

# TRIAD



This corps of engineers, in their own secluded laboratory keep TRIAD tubes ahead of the procession. They are provided with the most modern laboratory apparatus and make periodical checks of every operation on every one of the many types TRIAD produces.

**YOU GET**

**QUALITY**

**FROM A to Z**



**TRIAD  
QUALITY**

**IS A FACT--NOT MERELY  
A CLAIM**

The easiest way to get a true estimate of any product's worth is to ask about it among its competitors. Ask any serviceman, dealer, jobber or manufacturer if any tubes are better than TRIAD QUALITY TUBES. We know the answers you get will induce you to send in the coupon, which will bring you the whole, interesting story.



Elaborate testing equipment developed by TRIAD engineers is found at the end of every production line. QUALITY is the watchword, QUALITY is demanded and an increasing number of satisfied users prove that TRIAD and QUALITY are synonymous.

## PRICE LIST ON STANDARD TYPES RADIO TUBES

T-1	Mercury Half Wave Rectifier.....	\$ 2.60
T-01A	General Purpose Detector and Amplifier.....	.80
T-10	Power Amplifier.....	5.00
T-10S	High Voltage Power Amplifier.....	6.00
T-12A	D. C. Power Amplifier.....	1.30
T-22	D. C. Screen Grid Amplifier.....	2.00
T-24A	A. C. Screen Grid Amplifier.....	1.40
T-26	A. C. General Purpose Amplifier.....	.85
T-27	Detector or Amplifier having A. C. Heater.....	1.05
T-30	D. C. General Purpose Amplifier.....	1.30
T-31	D. C. Power Amplifier.....	1.30
T-32	D. C. Screen Grid Amplifier.....	1.90
T-33	D. C. Pentode Power Amplifier.....	2.10
T-34	D. C. Multi-Mu R. F. Amplifier.....	2.15
T-35	A. C. Heater Type Multi-Mu R. F. Amplifier.....	1.50
T-36	D. C. Screen Grid Amplifier, Heater Type.....	1.80
T-37	D. C. General Purpose Amplifier.....	1.40
T-38	D. C. Pentode Power Amplifier, Heater Type.....	1.60
T-39	D. C. Heater Type Multi-Mu R. F. Amplifier.....	1.80
T-40	D. C. Voltage Amplifier.....	2.00
T-41	Power Amplifier Pentode.....	1.60
T-45	A. C. Triode Power Amplifier.....	1.15
T-46	A. C. Power Amplifier.....	1.55
T-47	A. C. Pentode Power Amplifier.....	1.50
T-48	Power Amplifier Tetrode (30 volt DC Heater).....	3.00
T-50	A. C. Power Amplifier.....	4.00
T-51	A. C. Heater Type Multi-Mu R. F. Amplifier.....	1.50
T-55	A. C. Duplex Diode Triode.....	1.60
T-56	General Purpose Amplifier.....	1.20
T-57	A. C. Pentode R. F. Amplifier.....	1.65
T-58	A. C. Pentode Multi-Mu R. F. Amplifier.....	1.65
T-59	Heater Type Power Amplifier, Triple Purpose.....	2.00
T-864	D. C. General Purpose Amplifier.....	2.10
T-71A	A. C. or D. C. Power Amplifier.....	.95
T-85	D. C. Duplex Diode Triode.....	1.60
T-89	Triple Grid Power Amplifier.....	1.80
T-99X	Dry Battery General Purpose Amplifier.....	1.50
T-99V	Dry Battery General Purpose Amplifier.....	2.25
T-841	Power Amplifier.....	10.40
T-842	Heavy Duty Power Amplifier or Modulator.....	10.40
T-66	Half Wave Mercury Rectifier.....	6.75
T-90	Full Wave Rectifier.....	.90
T-51	Half Wave Rectifier.....	3.50
T-82	Full Wave Mercury Vapor Rectifier.....	1.20
T-83	Heavy Duty Full Wave Mercury Rectifier.....	1.55
T-171	Television Scanning.....	Price on Application
T-172	Television Projection.....	
T-173	Photo-Electric Cell.....	
T-200	Sound Movie Power Amplifier.....	7.75



TRIAD MFG. CO.,  
Pawtucket, R. I.  
Gentlemen:—

Please send me full information about TRIAD QUALITY tubes.

\_\_\_\_\_

\_\_\_\_\_

\_\_\_\_\_

TRIAD MANUFACTURING CO.

PAWTUCKET, R. I.

# "Four Radios in One" The NEW Lincoln

— Lt. Comdr. R. H. G. Mathews, USNR

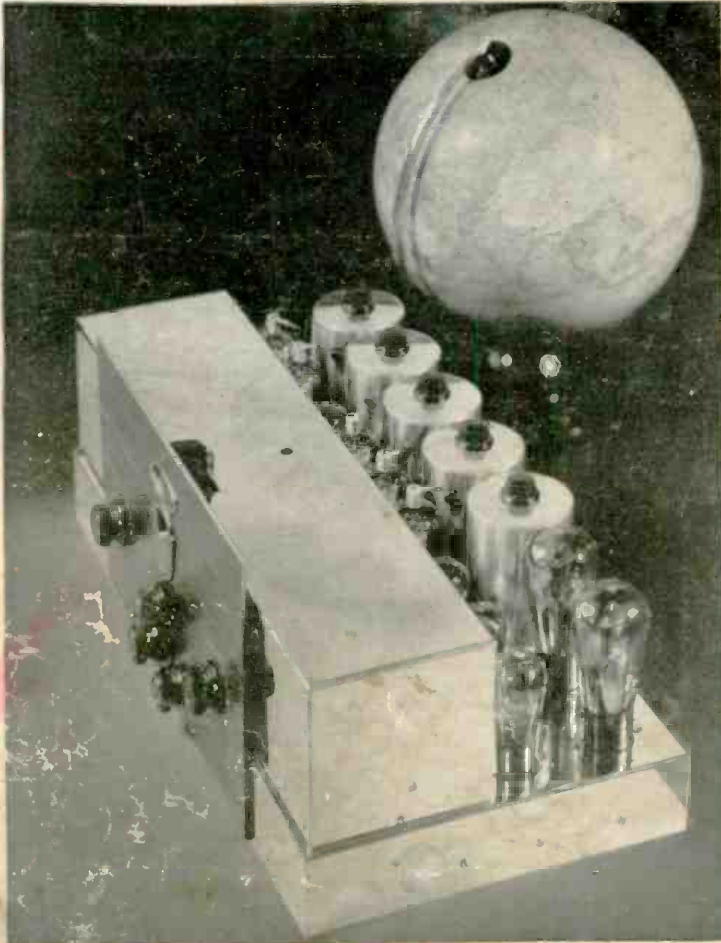

"I have always had a number of receivers for my own amusement—each built for a specific purpose. A set especially for CW, one for foreign short-wave reception, a set with nothing but tone, and a 'hot' selective super for DX broadcast reception. It is generally believed among radio engineers that you can't have them all in one receiver . . . I subscribed to this belief until I played with one of the NEW Lincolns. I was surprised to find, in this one set, all the advantages of my four specialized receivers . . ."

The above is taken from a letter from Lt. Comdr. R. H. G. Mathews, famed radio engineer, builder of broadcast stations, short-wave stations, former internationally renowned amateur and commercial operator, and, until recently, Commander of the Communication Division of the United States Naval Reserve in the 9th District.



Anc' Lieutenant Commander Mathews' enthusiasm for the NEW Lincoln will not half equal yours when you feel its smooth ease of operation, discover for the first time how amazingly simple foreign broadcast reception really can be, check its almost limitless sensitivity, and listen to its powerful reproduction of the full musical scale. Write or send the coupon NOW for full details.

Sign coupon for prices, logs of foreign stations, etc.

LINCOLN RADIO CORPORATION  
333 S. Wood St., Chicago, U.S.A.  
Please send me FREE technical description of the New Lincoln.

Name \_\_\_\_\_  
Street \_\_\_\_\_  
City \_\_\_\_\_ State \_\_\_\_\_

**LINCOLN**  
*De Luxe Receivers*